



# CITY

60418





LEGO® Builder



[LEGO.com/sustainable-packaging](https://LEGO.com/sustainable-packaging)



**FR**  
**DONNEZ**  
OU  
**RECYCLEZ**

 OU  OU 

ASSOCIATION MAGASIN DÉCHÈTERIE

Adresses sur [quefairedemesdechets.fr](https://quefairedemesdechets.fr)

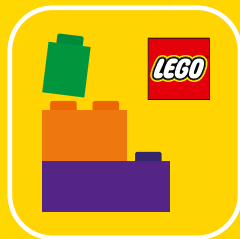

# BUILDER



Apple and the Apple logo are trademarks of Apple Inc., registered in the U.S. and other countries and regions. App Store is a service mark of Apple Inc. Google Play and the Google Play logo are trademarks of Google LLC. Tencent and the Tencent logo are trademarks of Tencent Inc.

Q [LEGO.com/devicecheck](https://www.lego.com/devicecheck)

**EN** Ask parents' permission before going online | **DE** Eltern um Erlaubnis bitten, bevor du online gehst | **FR** Demande l'autorisation d'un parent avant d'aller en ligne | **IT** Chiedi il permesso ai tuoi genitori prima di andare online | **ES** Pídeles permiso a tus papás antes de conectarte a Internet | **PT** Pede autorização aos pais antes de acederes online | **ZH** 上网前应先征得父母的同意 | **PL** Poproś rodziców o zgodę, zanim wejdziesz do Internetu | **CS** Než půjdeš na internet, požádej rodiče o svolení | **SK** Skôr než pôjdeš na internet, vypýtaj si povolenie od rodičov | **HU** Kérj szülői engedélyt, mielőtt online csatlakoznál! | **RO** Cere permisiunea părinților înainte de a te conecta online | **BG** Поискайте разрешение от родител, преди да влезете онлайн | **LV** Pirms došanās tiešsaistē palūdz atļauju vecākiem | **ET** Enne Interneti kasutamist küsi vanematelt luba | **LT** Prieš prisijungdami prie interneto, atsiklauskite tėvų

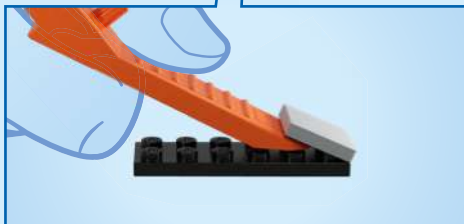
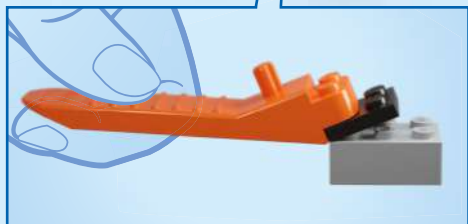
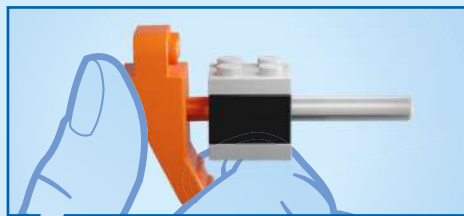

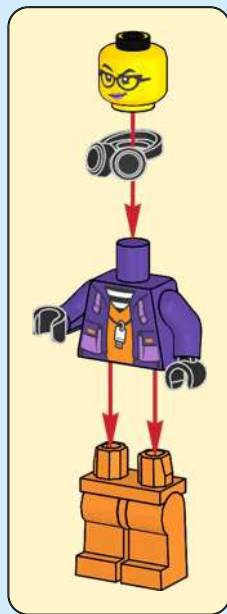

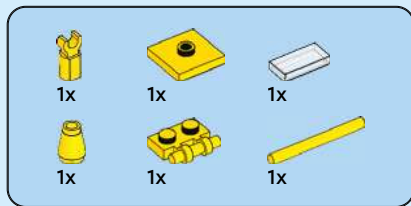
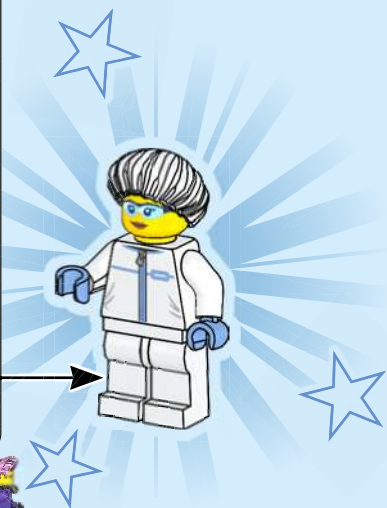
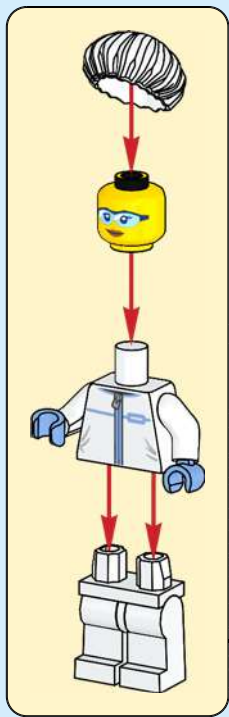

1

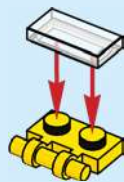

2

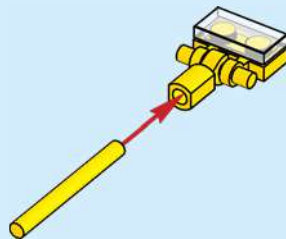

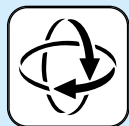

3

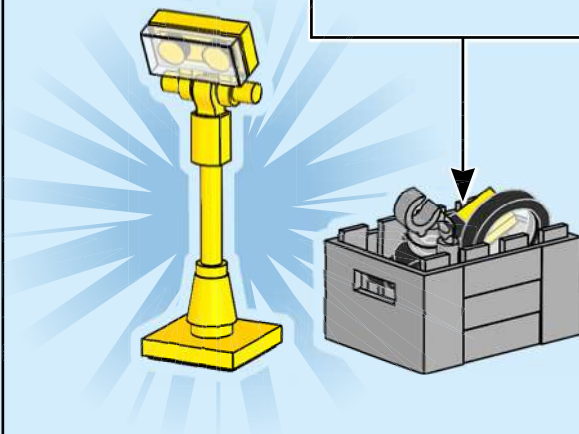
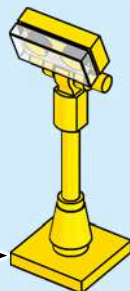
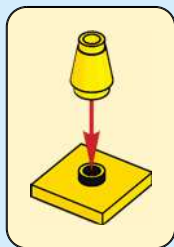

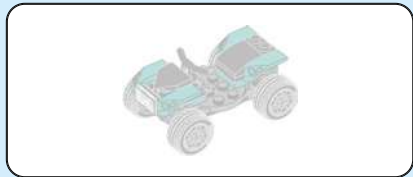

1

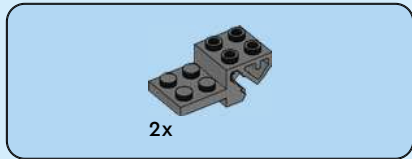

2

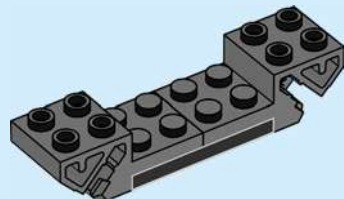



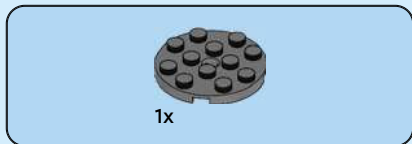

3

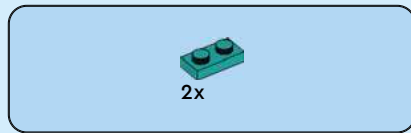
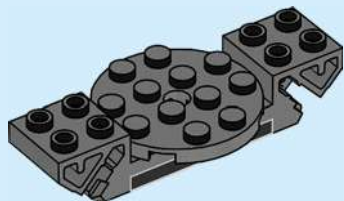

4

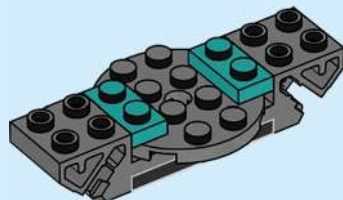



2x

5

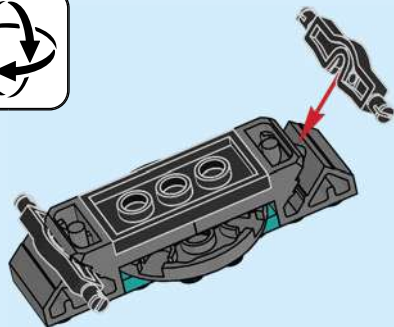

2x



1x

6

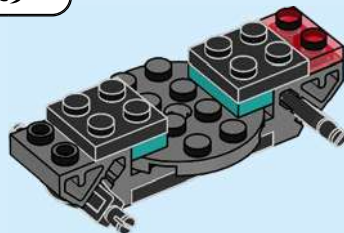

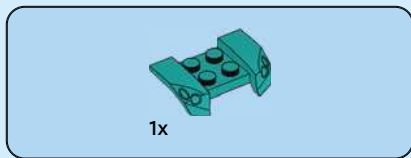

7

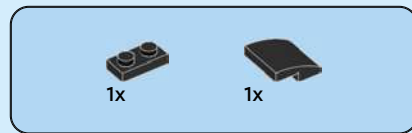
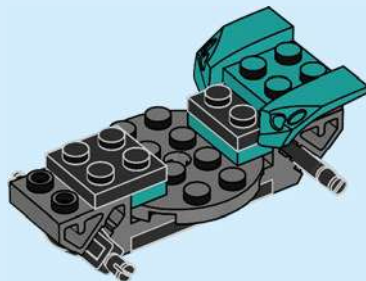

8

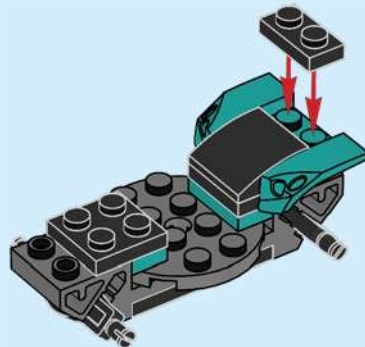

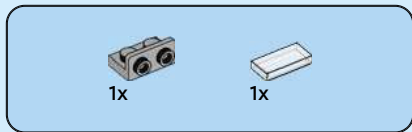

9

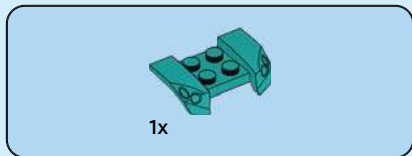
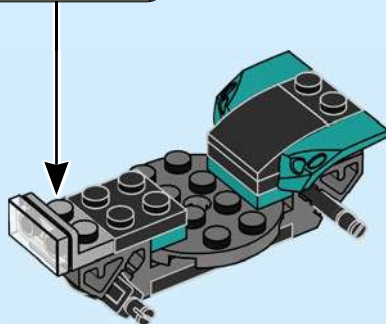
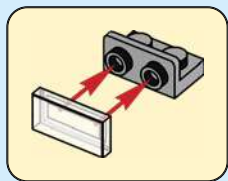

10

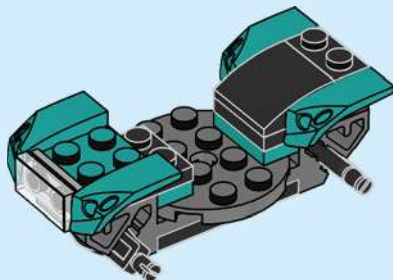



11

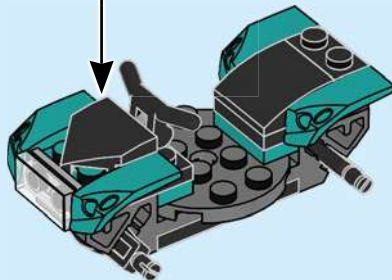
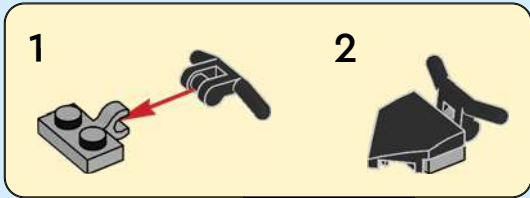

12

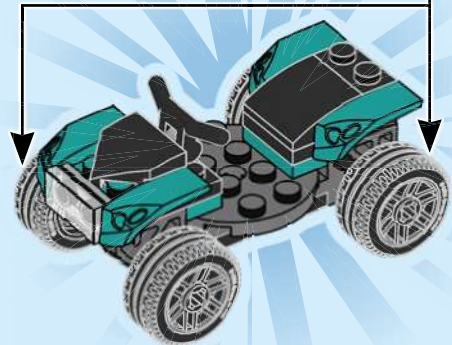
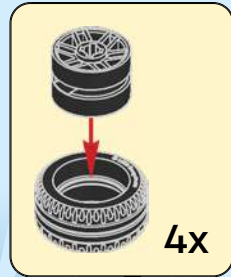

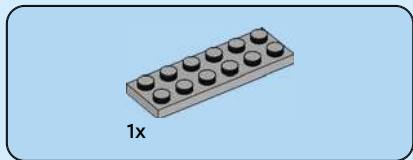
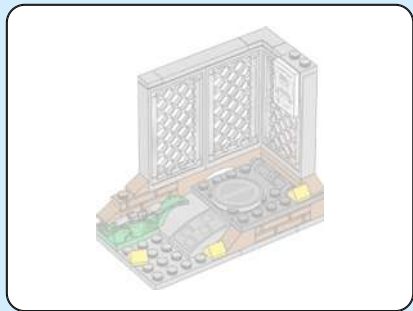

1

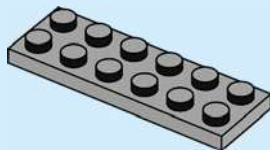

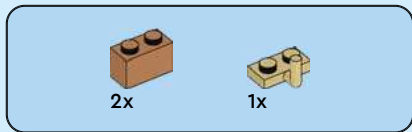

2

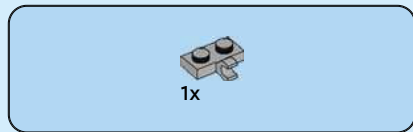
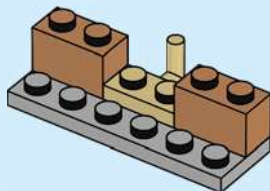

3

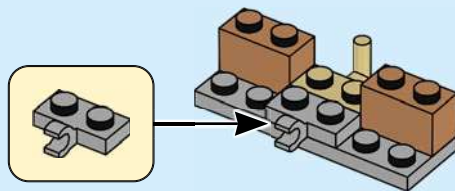



1x

4

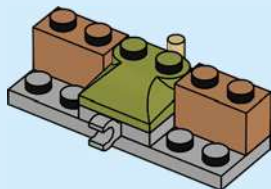

1x



2x

5

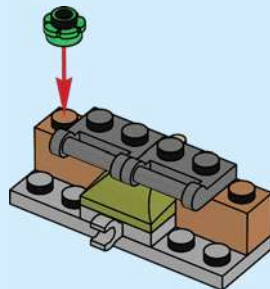



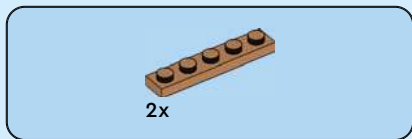

6

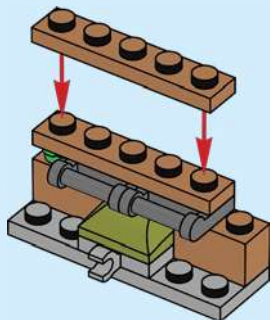

7

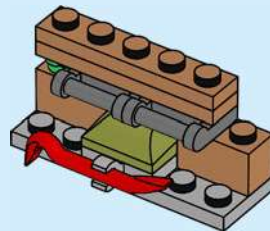

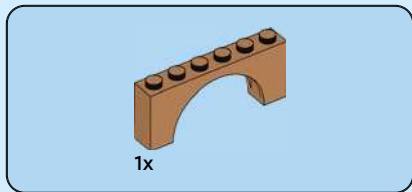

8

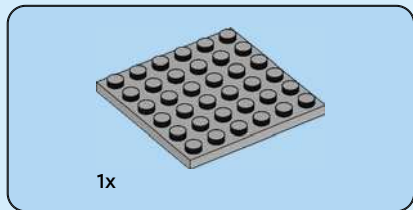
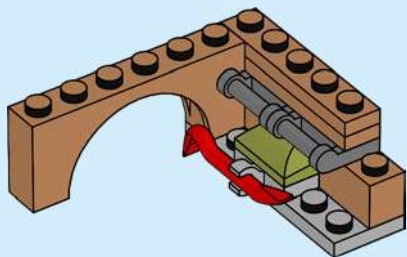

9

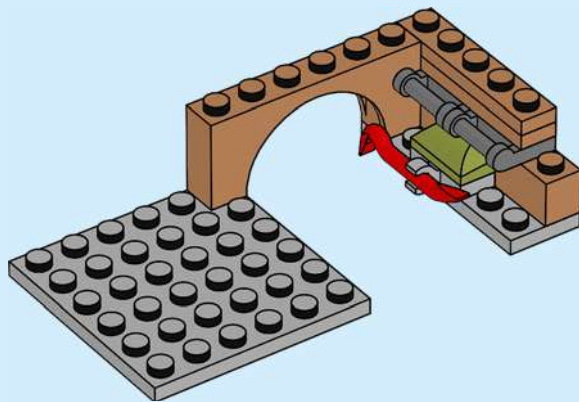

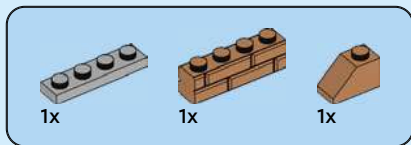

10

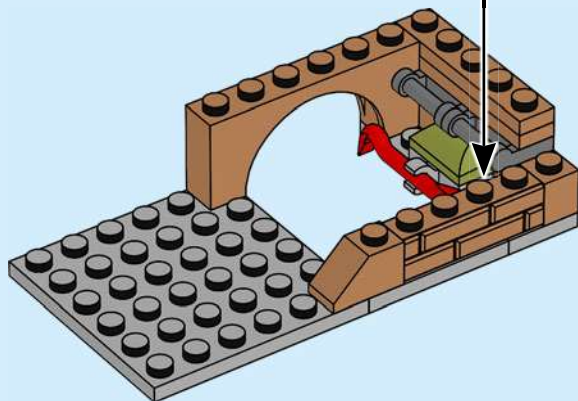
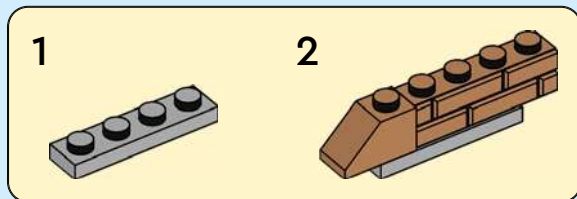

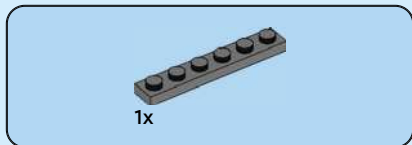

11

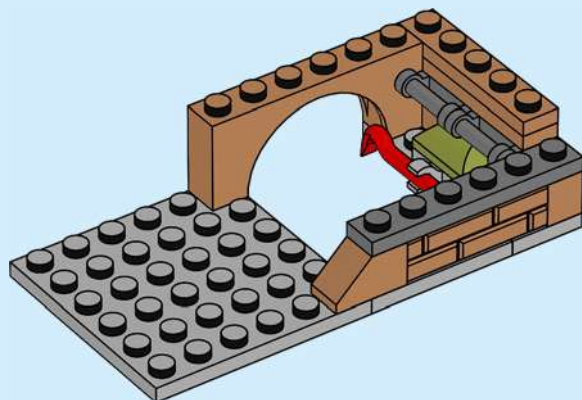



1x

12

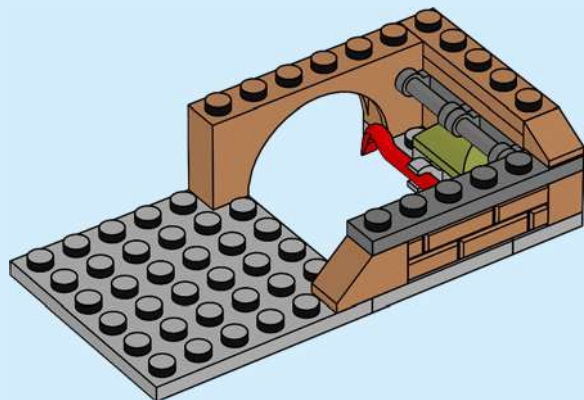

2x



1x

13

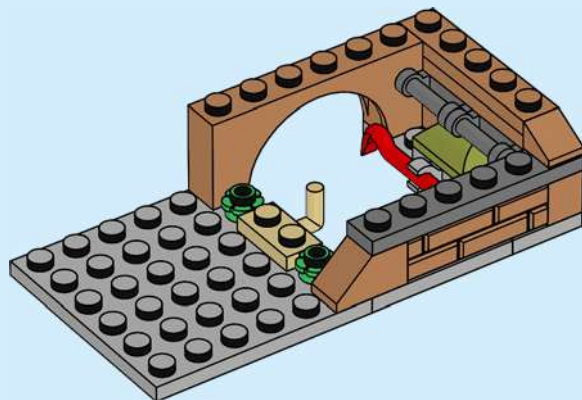

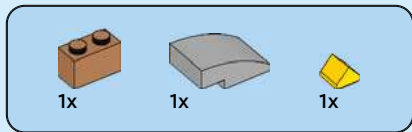

14

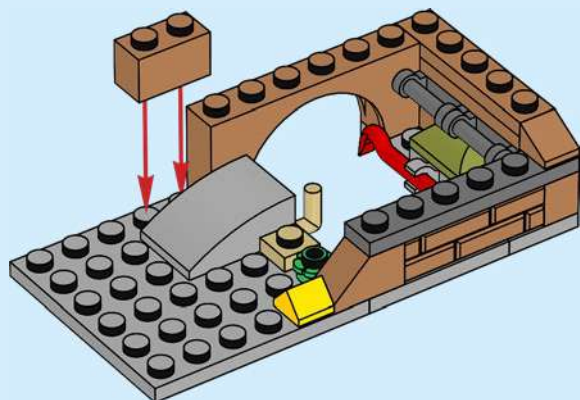

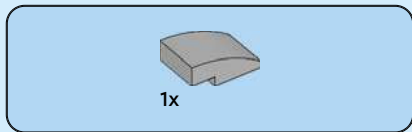

15

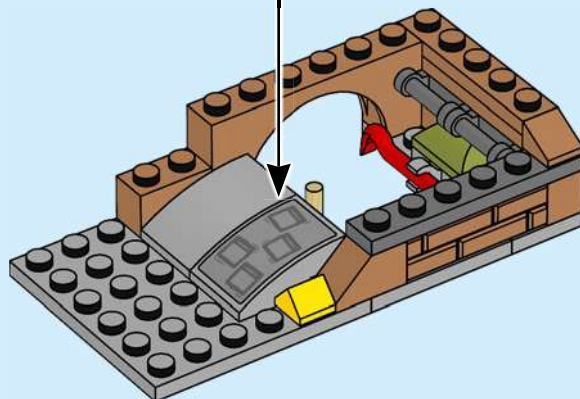
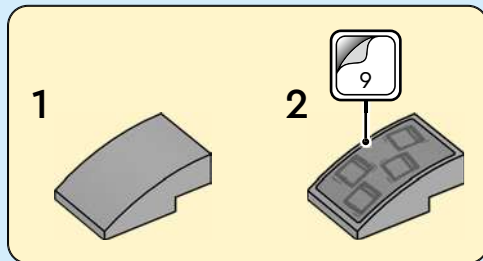

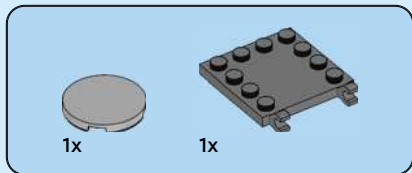

16

1



2



3

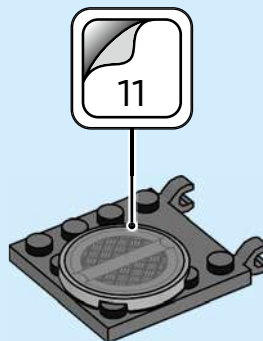



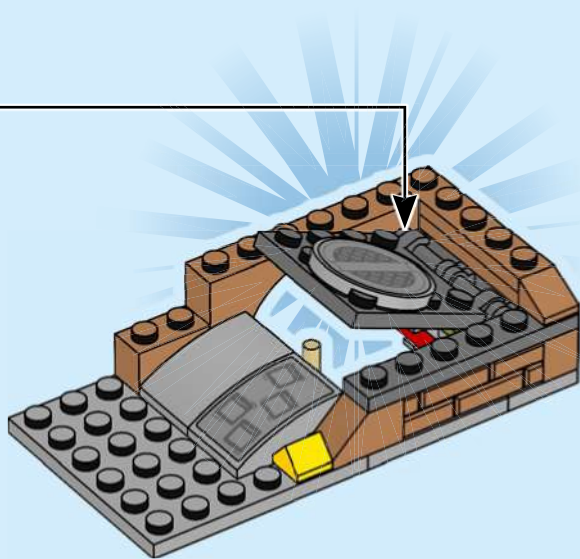

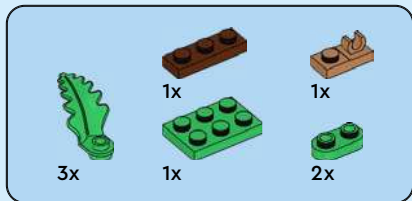

17

1

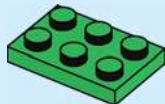

2



3



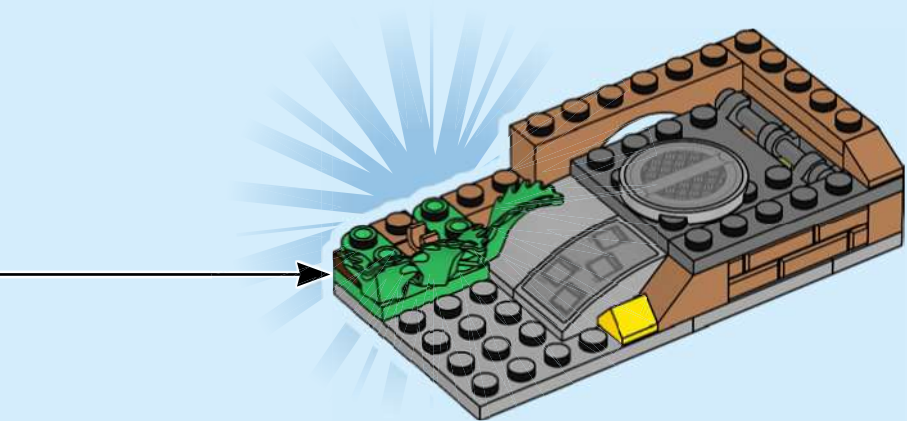



1x



1x

# 18





1x

19



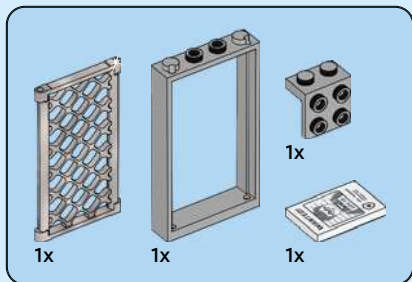

20

1

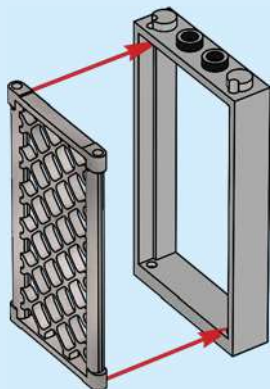

2

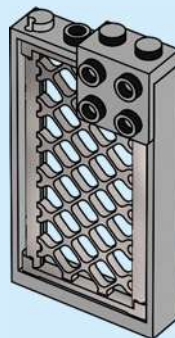

3

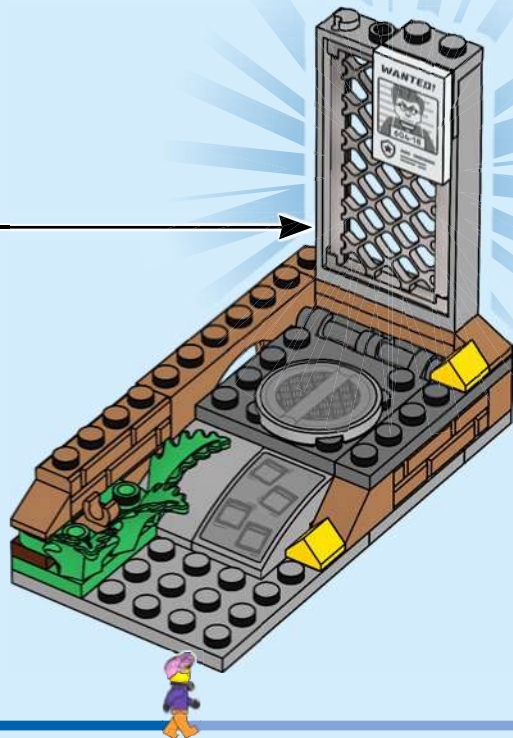



2x

21

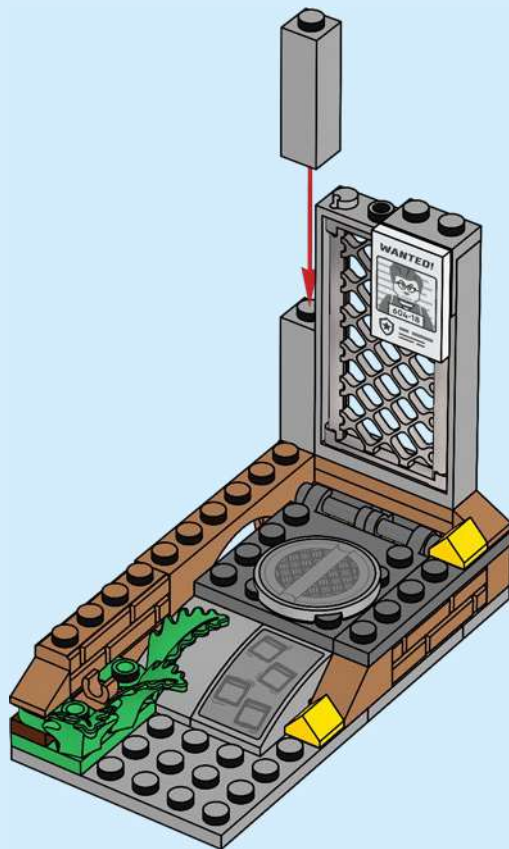



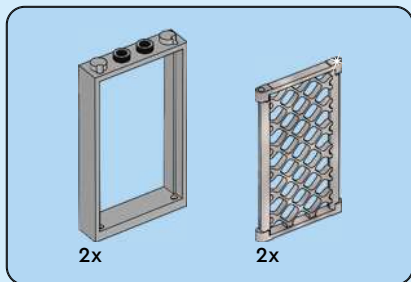

22

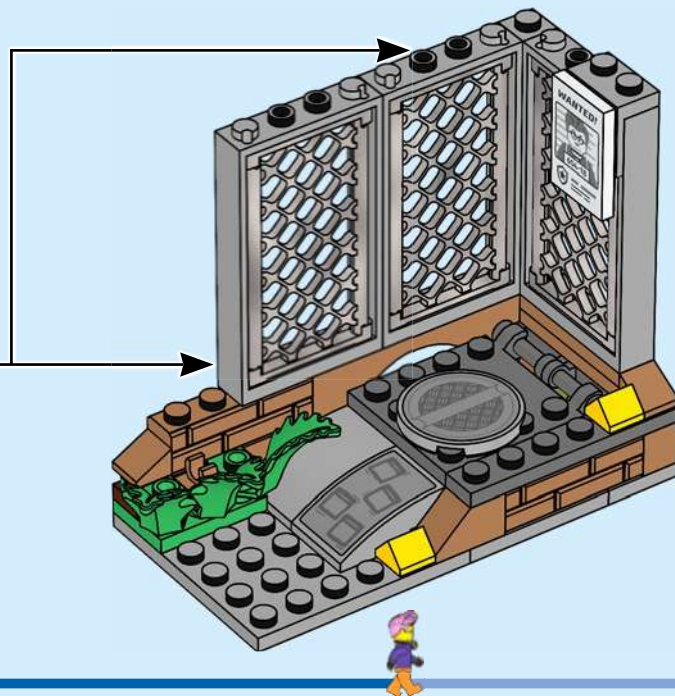
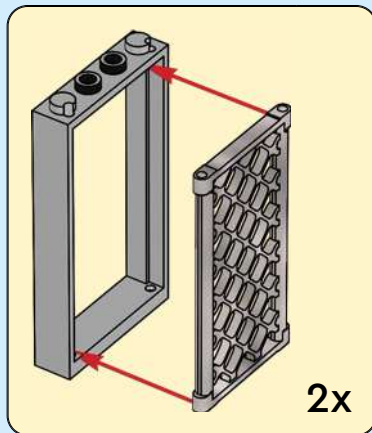



1x



1x

# 23

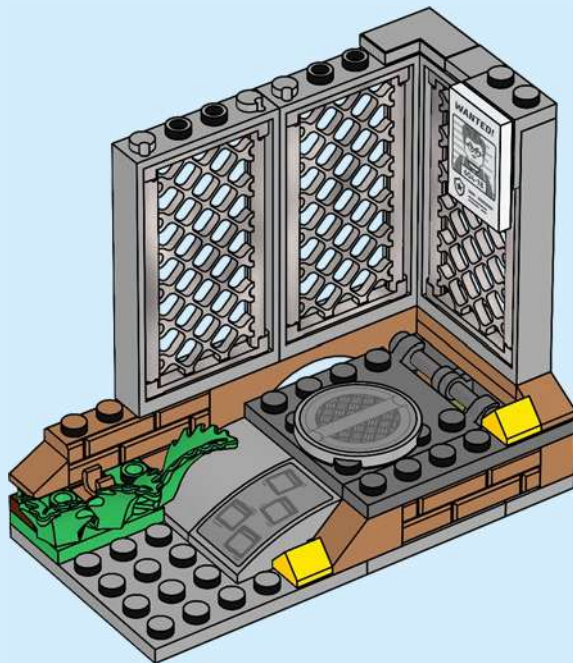

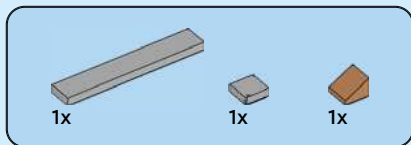

24

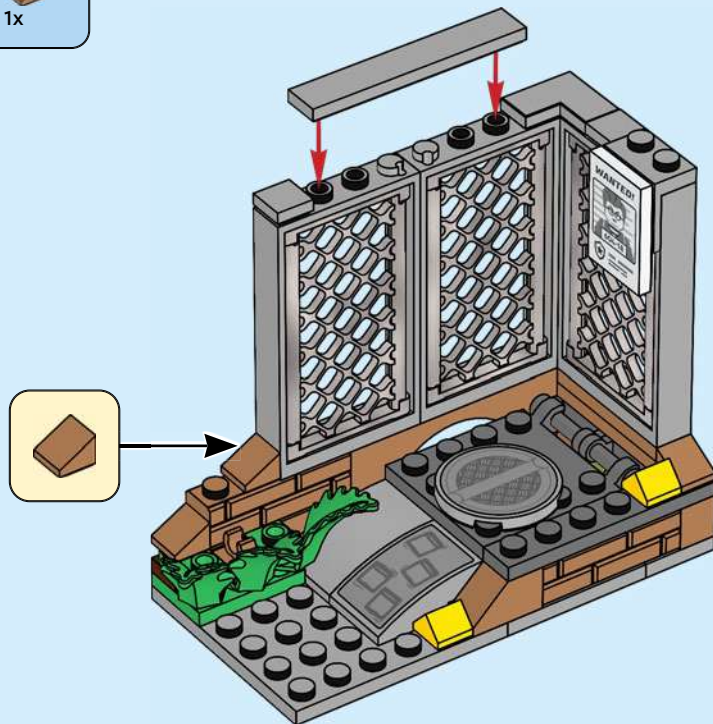



1x



1x

# 25

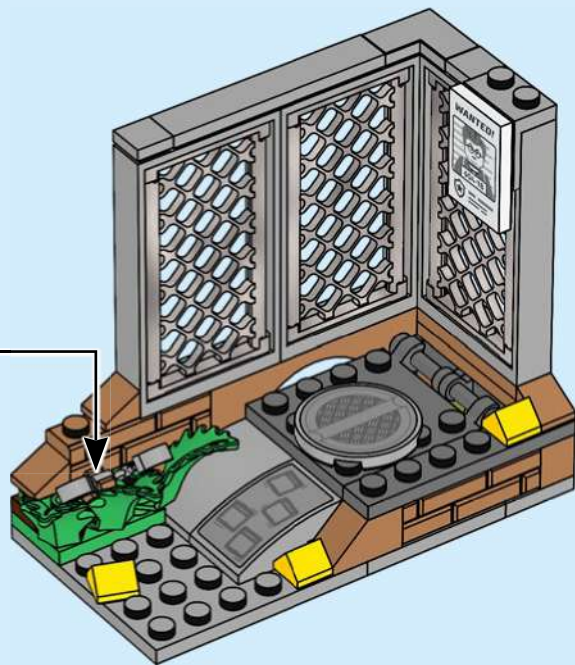
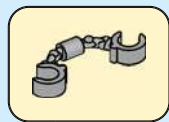

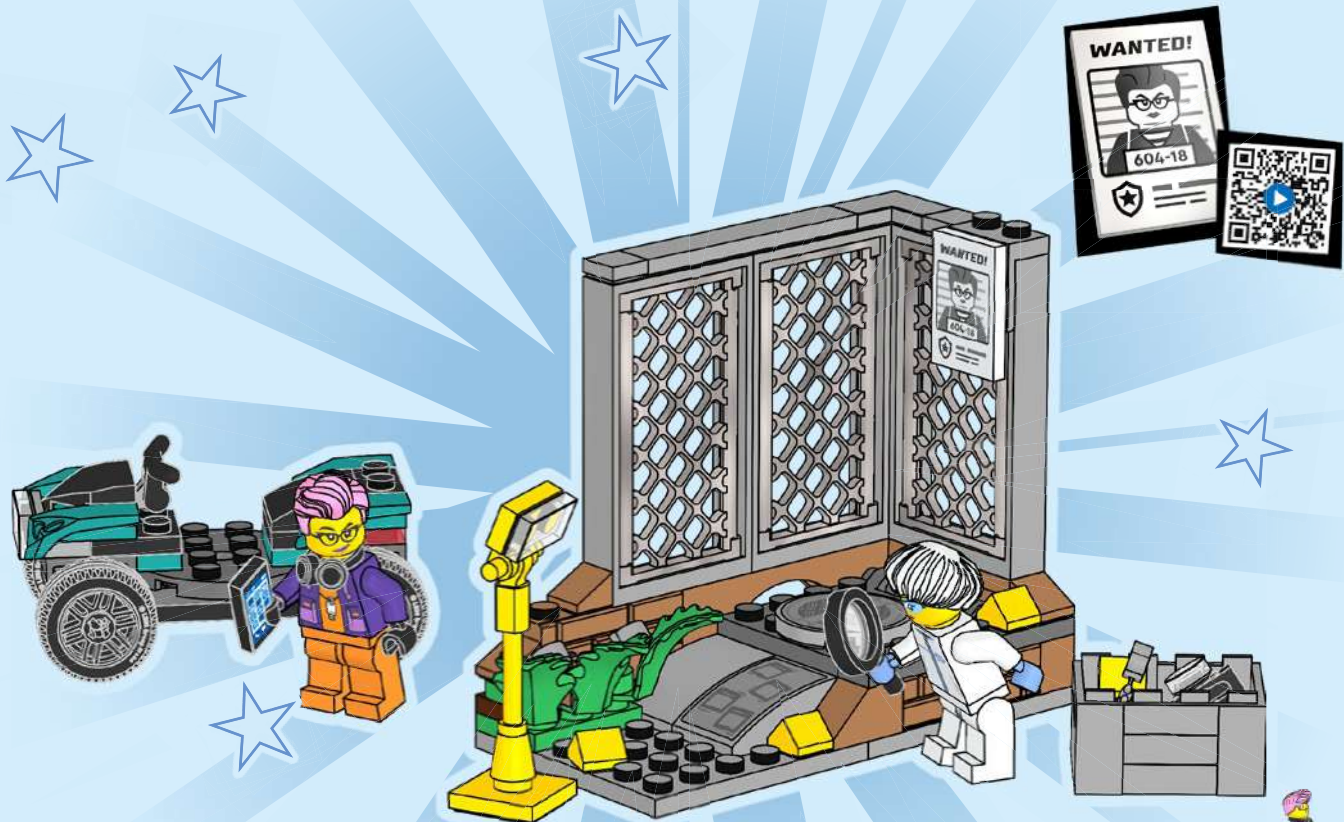

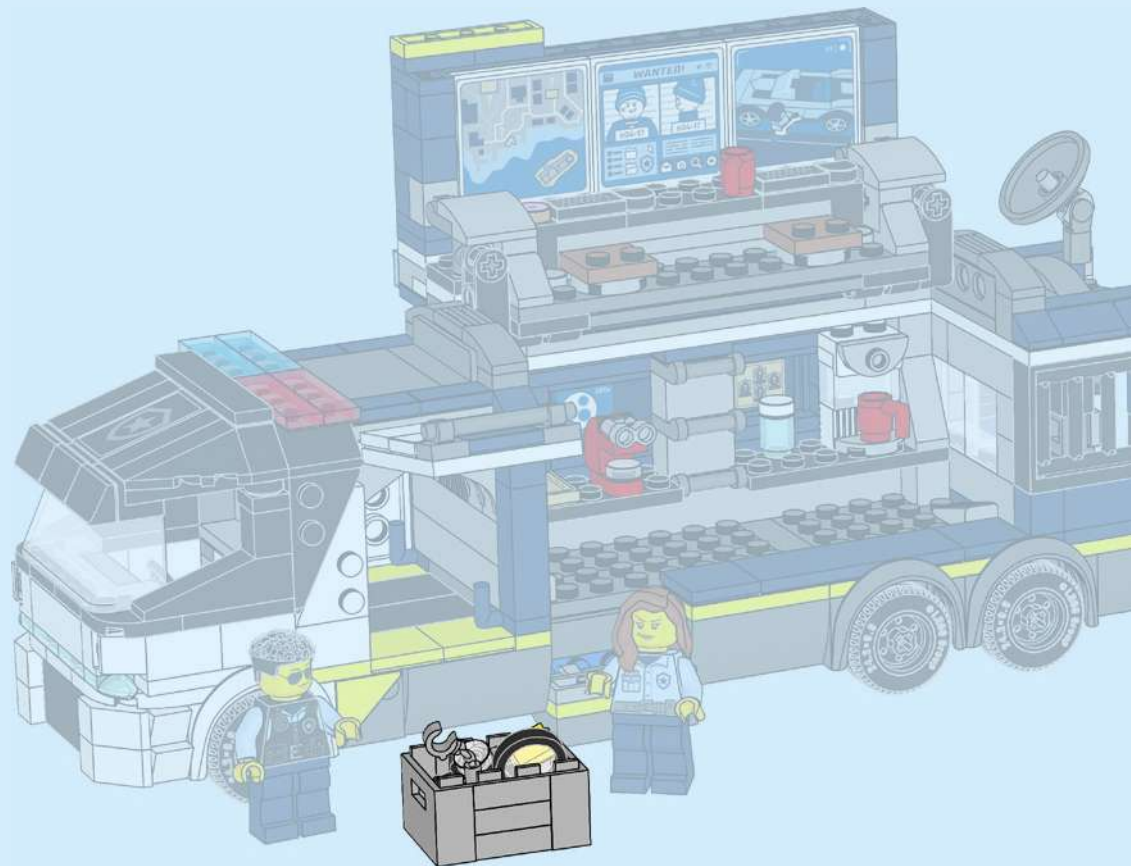

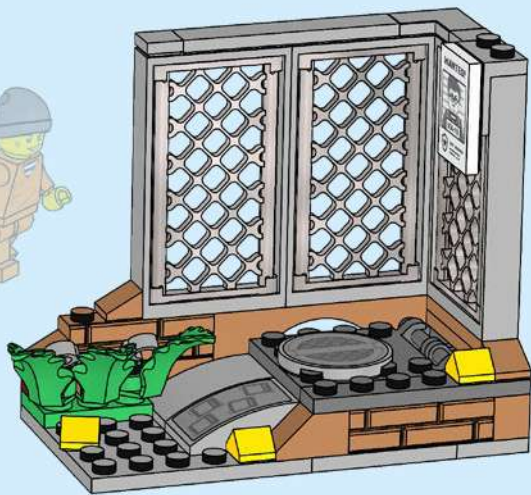



Rebuild  
the  
world™

