



CITY

60430



LEGO® Builder



LEGO.com/sustainable-packaging



FR
DONNEZ
OU
RECYCLEZ

 OU  OU 

ASSOCIATION MAGASIN DÉCHÈTERIE

Adresses sur quefairedemesdechets.fr

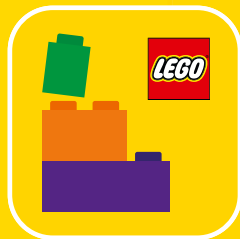

BUILDER



Apple and the Apple logo are trademarks of Apple Inc., registered in the U.S. and other countries and regions. App Store is a service mark of Apple Inc. Google Play and the Google Play logo are trademarks of Google LLC. Tencent and the Tencent logo are trademarks of Tencent Inc.

Q [LEGO.com/devicecheck](https://www.lego.com/devicecheck)

EN Ask parents' permission before going online | **DE** Eltern um Erlaubnis bitten, bevor du online gehst | **FR** Demande l'autorisation d'un parent avant d'aller en ligne | **IT** Chiedi il permesso ai tuoi genitori prima di andare online | **ES** Pídeles permiso a tus papás antes de conectarte a Internet | **PT** Pede autorização aos pais antes de acederes online | **ZH** 上网前应先征得父母的同意 | **PL** Poproś rodziców o zgodę, zanim wejdziesz do Internetu | **CS** Než půjdeš na internet, požádej rodiče o svolení | **SK** Skôr než pôjdeš na internet, vypýtaj si povolenie od rodičov | **HU** Kérj szülői engedélyt, mielőtt online csatlakoznál! | **RO** Cere permisiunea părinților înainte de a te conecta online | **BG** Поискайте разрешение от родител, преди да влезете онлайн | **LV** Pirms došanās tiešsaistē palūdz atļauju vecākiem | **ET** Enne Interneti kasutamist küsi vanematelt luba | **LT** Prieš prisijungdami prie interneto, atsiklauskite tėvų

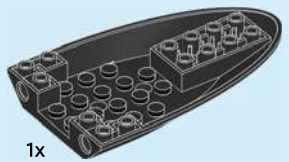
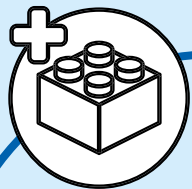

1x

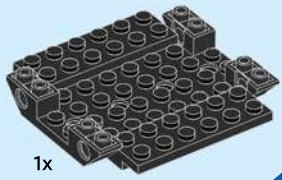

1x



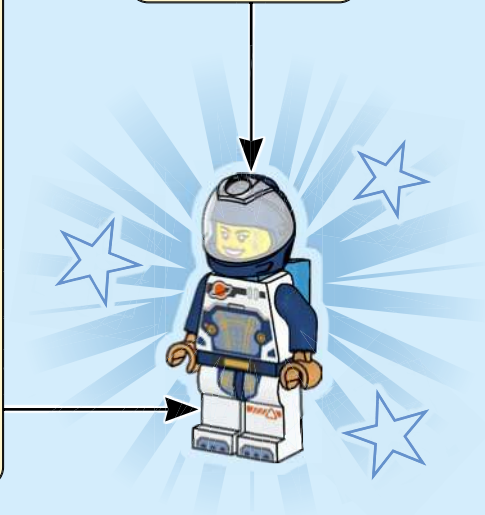
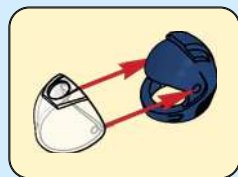
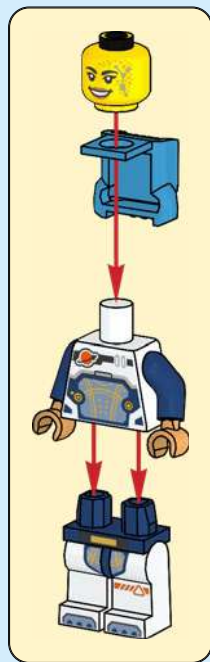



1x



1x

1

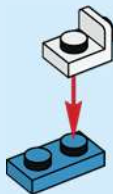



1x

2



1x

3





1x

4



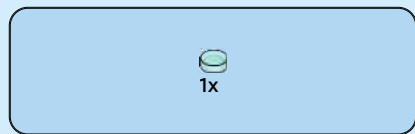

5

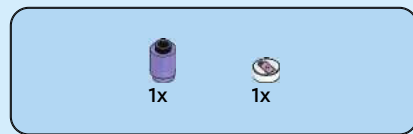
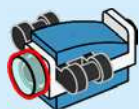

6

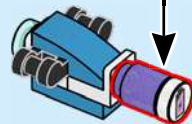
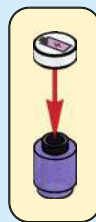

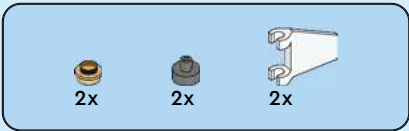

7

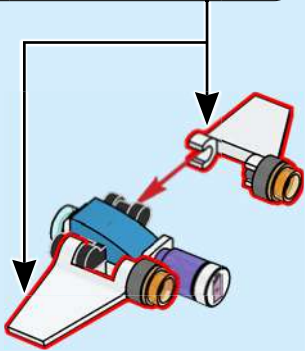
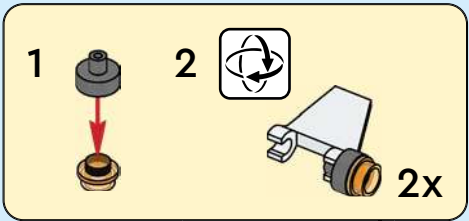

8

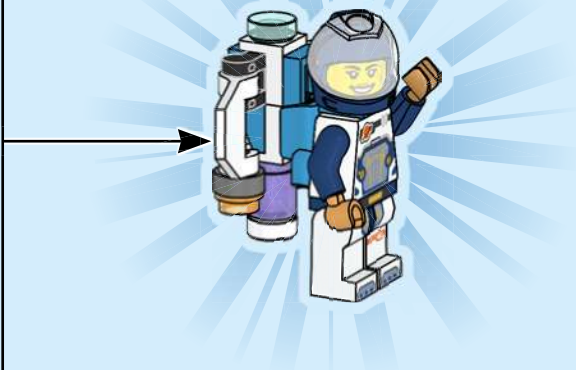

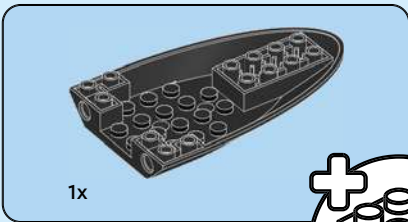
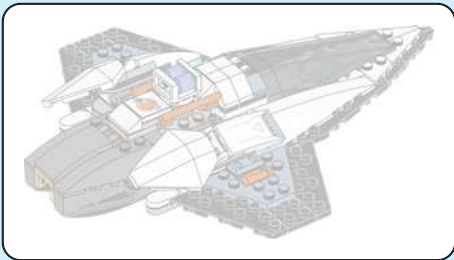

1

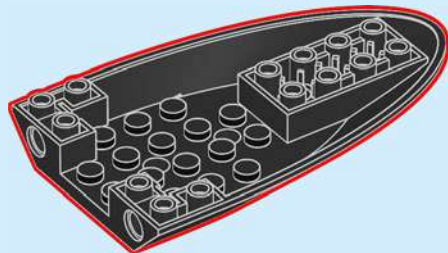
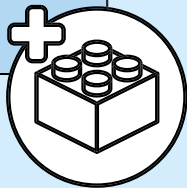



2x

2

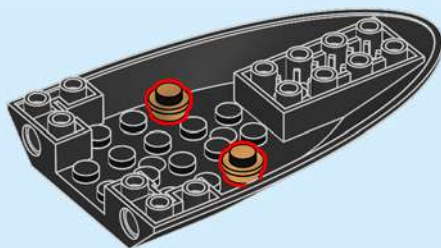

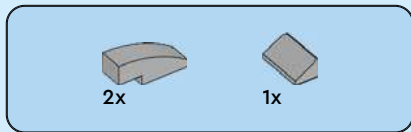

3

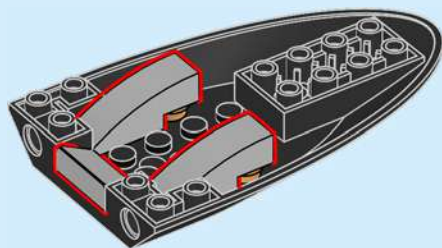

4

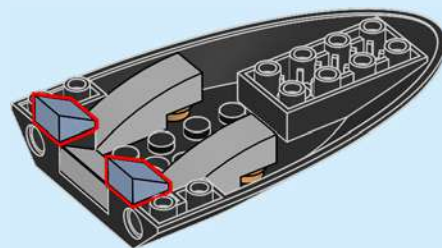



2x

5

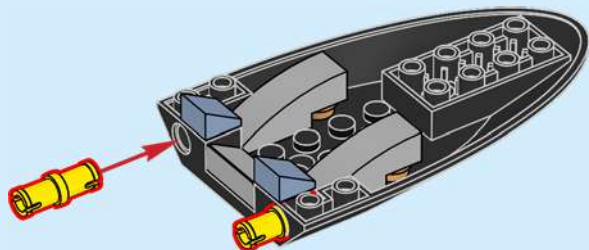

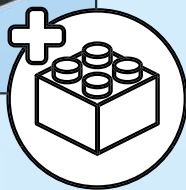
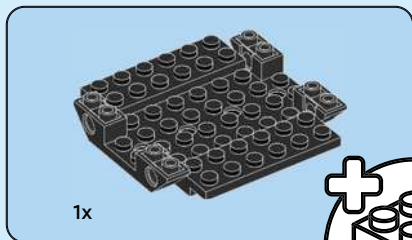

6

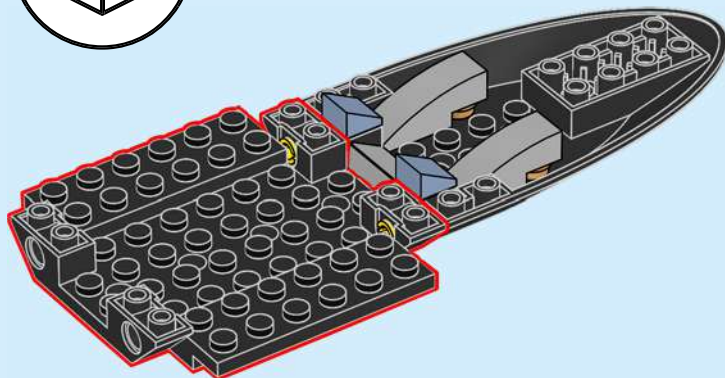

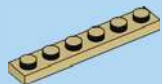

2x

7

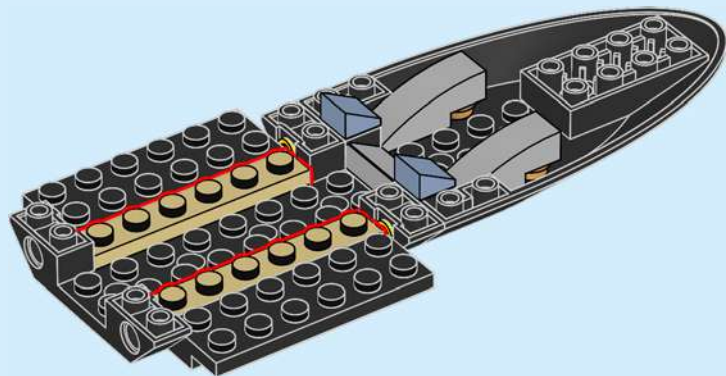



8

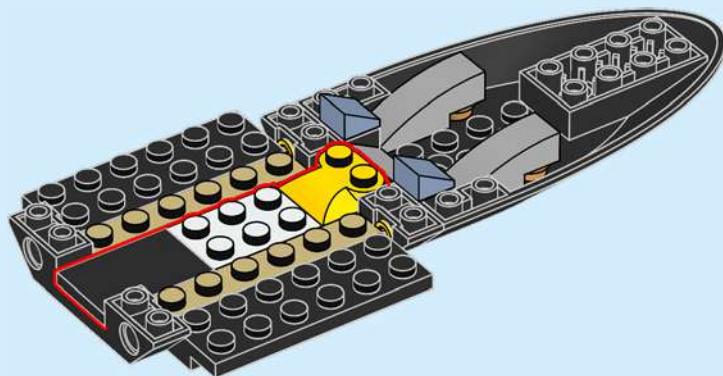



4x

9

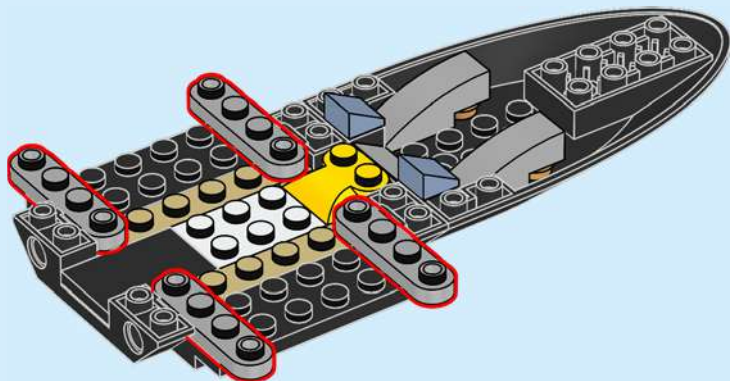

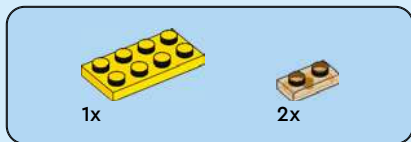

10

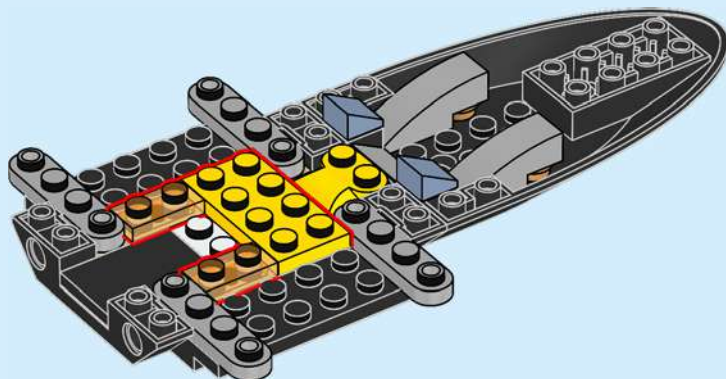

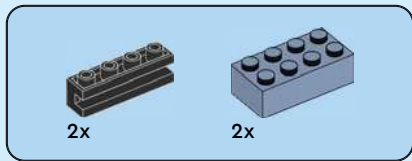

11

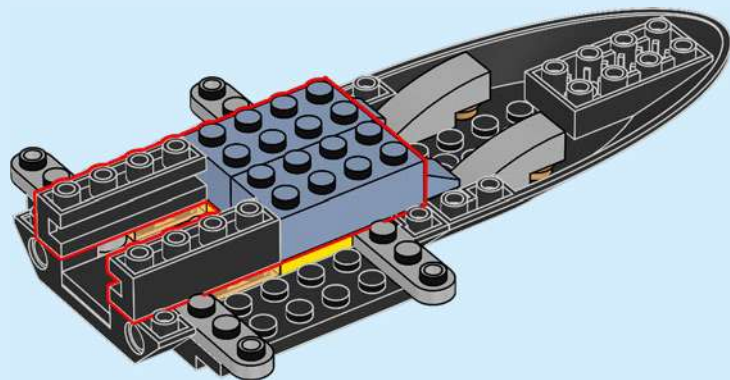



4x

12

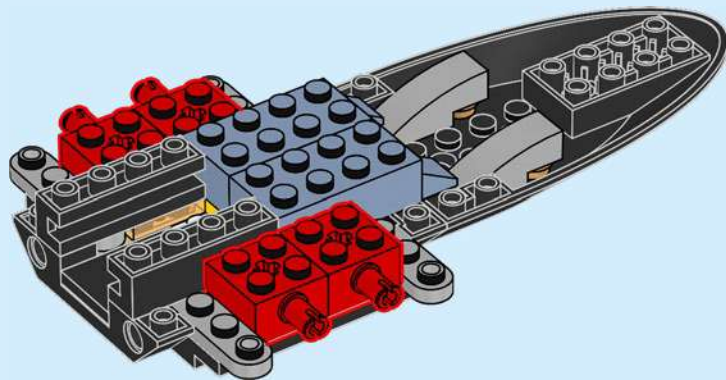



2x

13

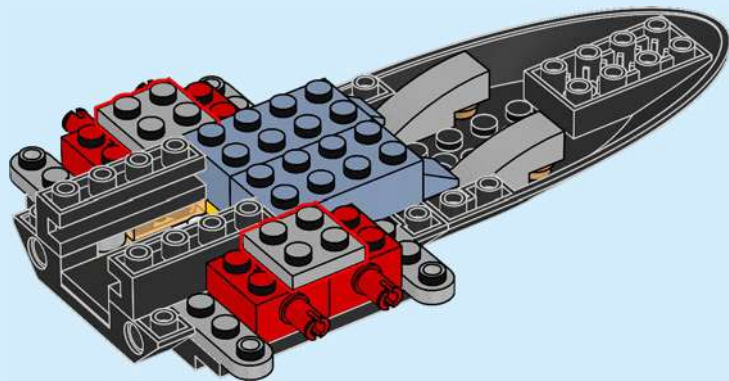



1x

14



1x

15





1x

16

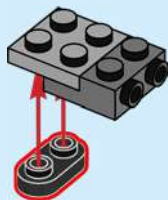



1x

17

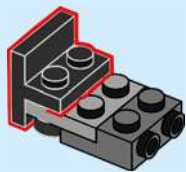

2x

18





1x

19

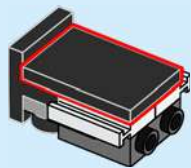



1x



1x

20

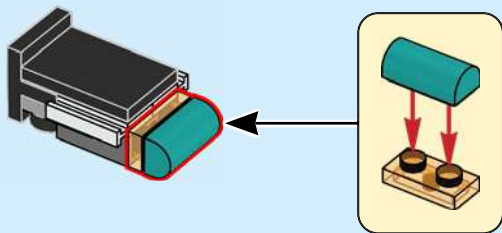

1x

21

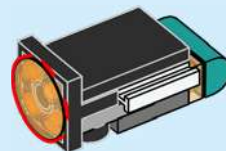

22

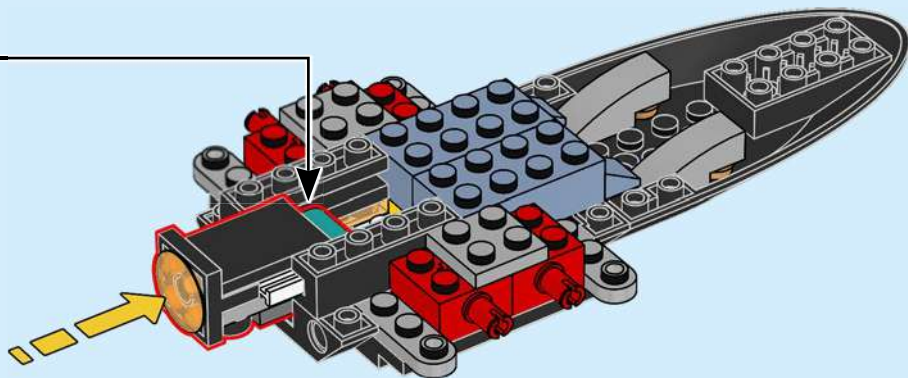



2x

23

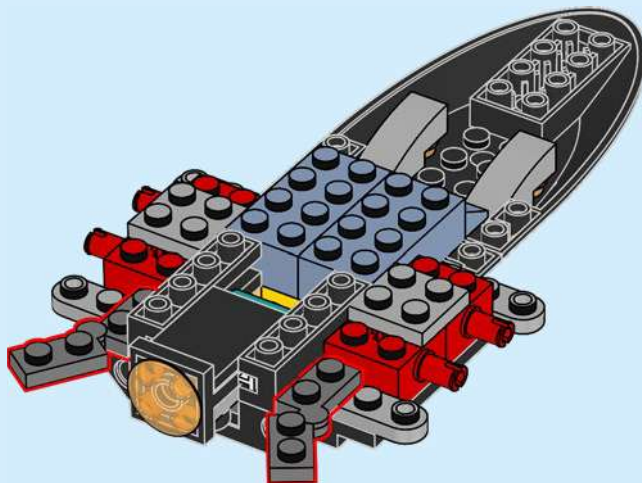



2x

24

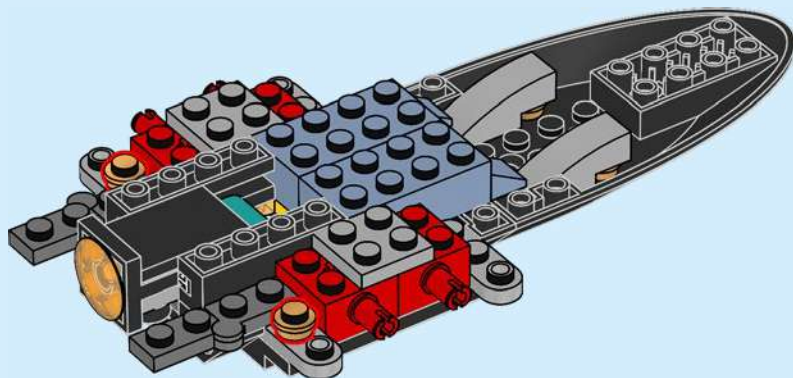



25

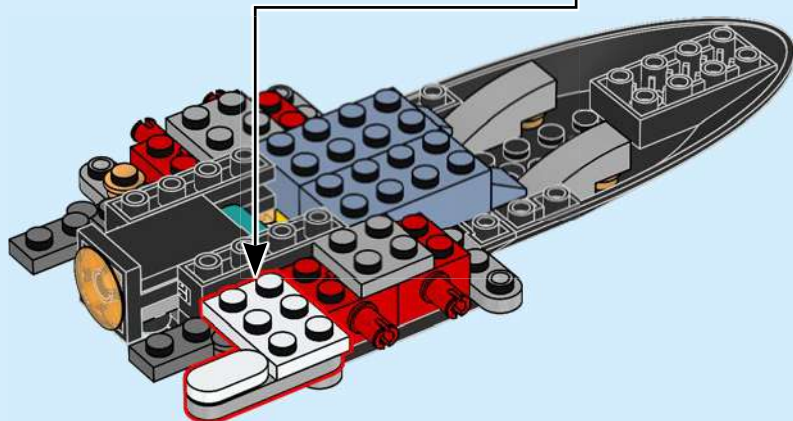
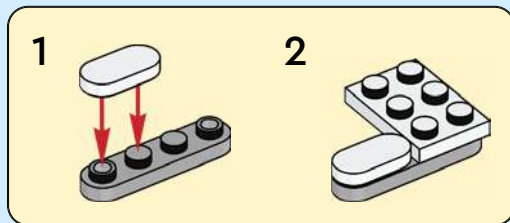

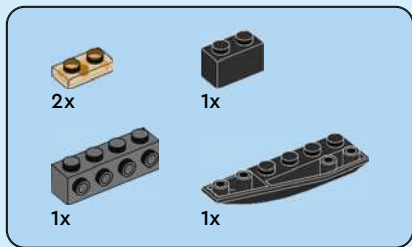

26

1

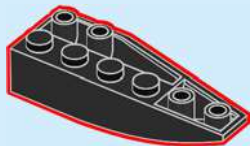

2

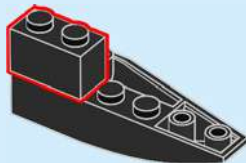

3

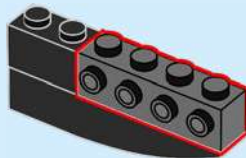

4

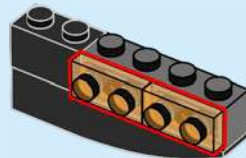

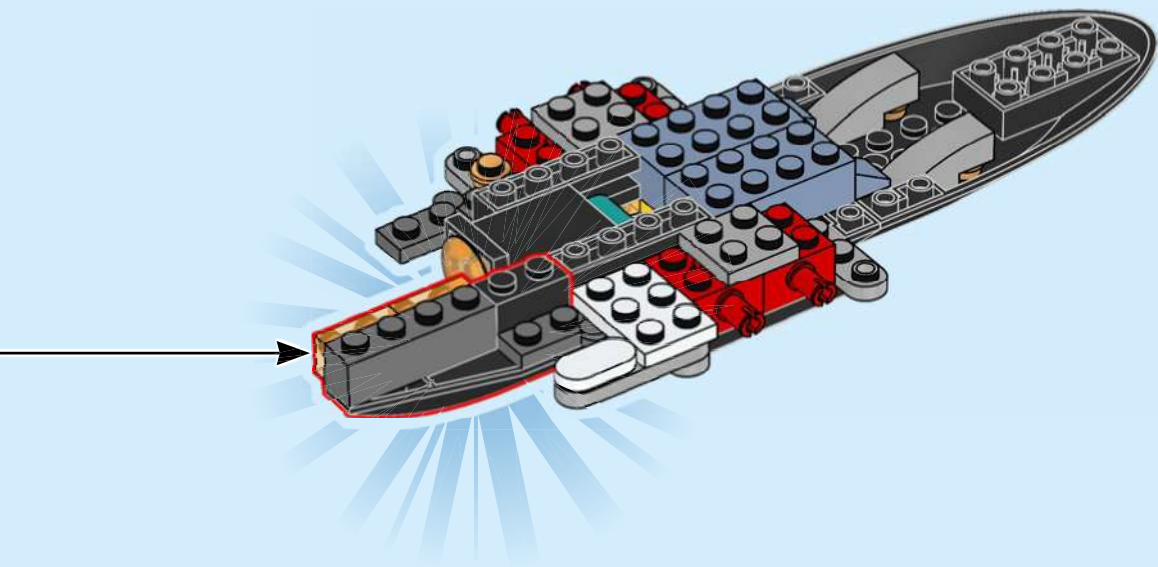



27

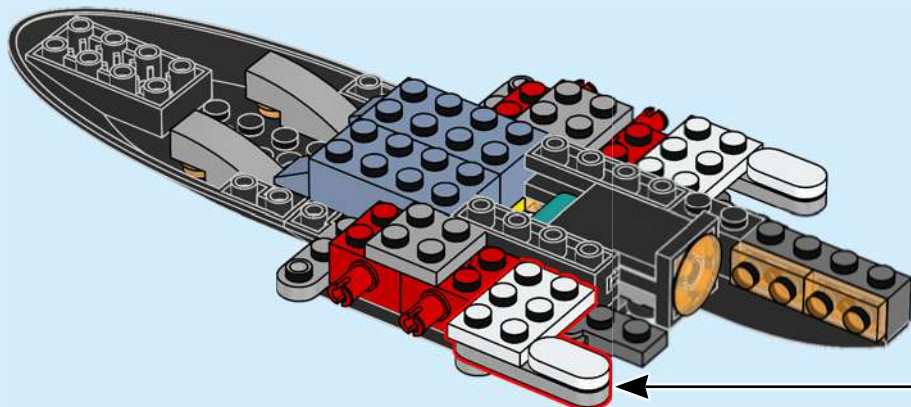
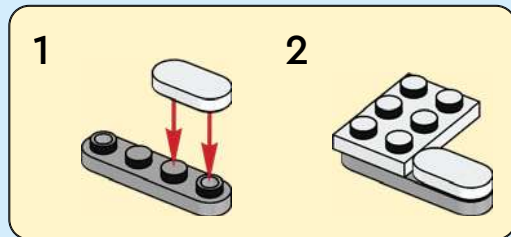

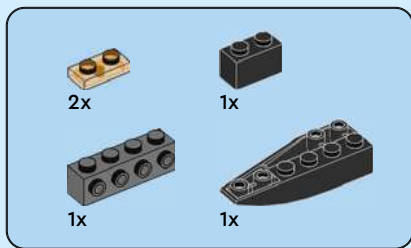

28

1



2

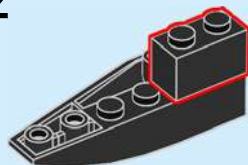

3

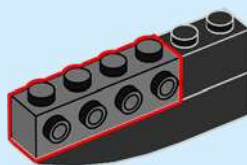

4



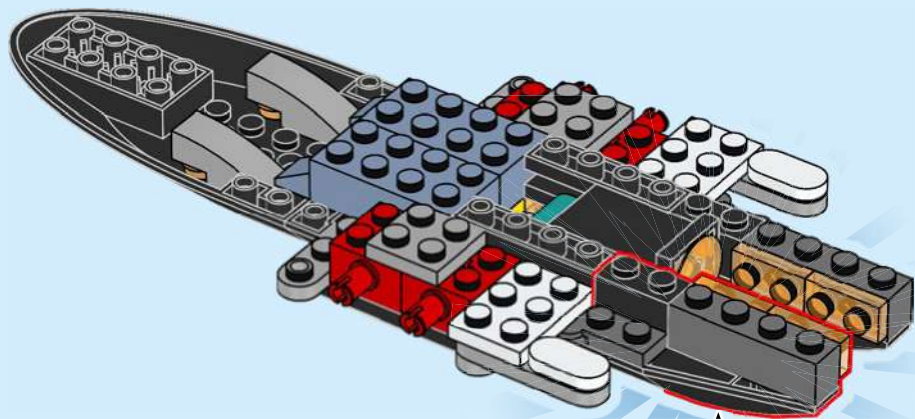



2x

29



2x

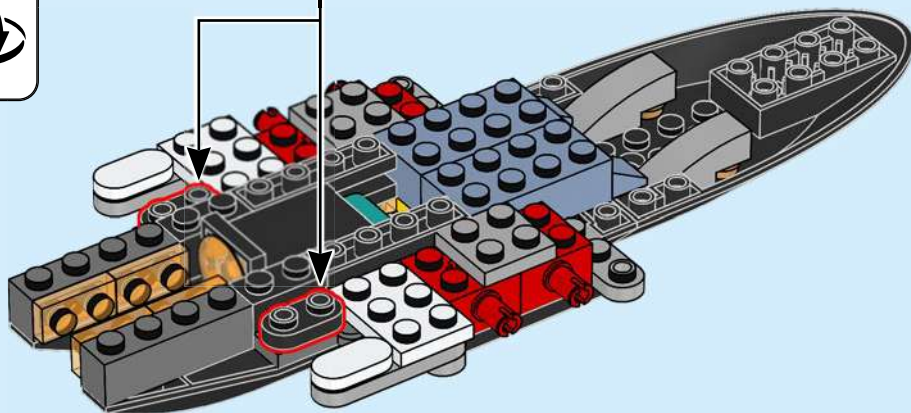



2x

30

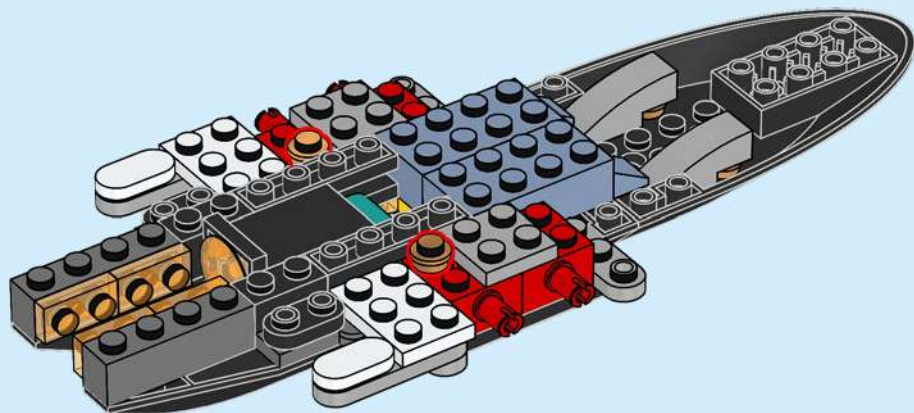

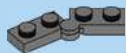

2x

31

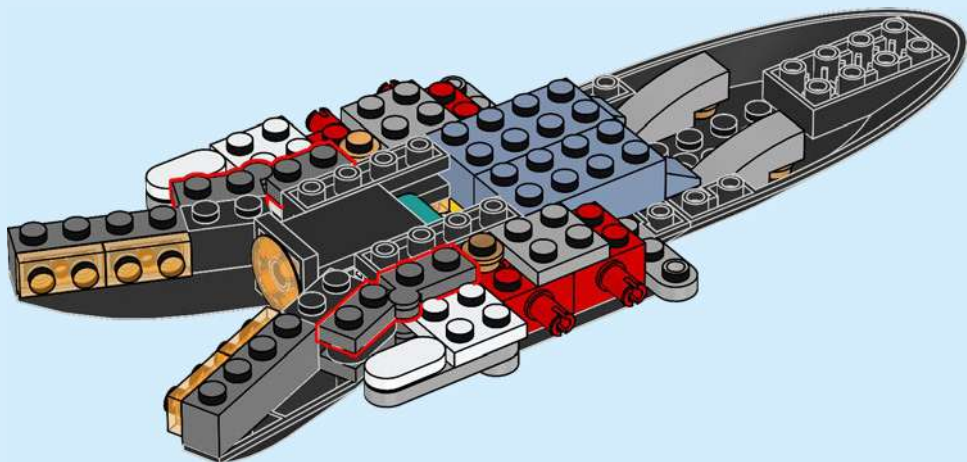



32

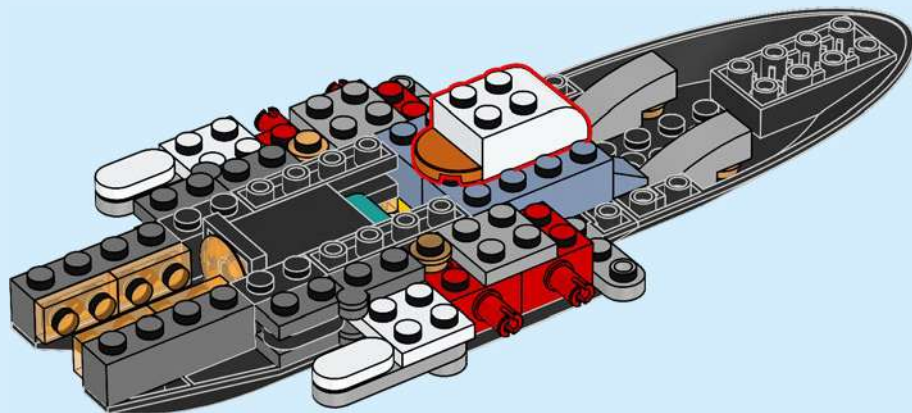



2x



2x

33

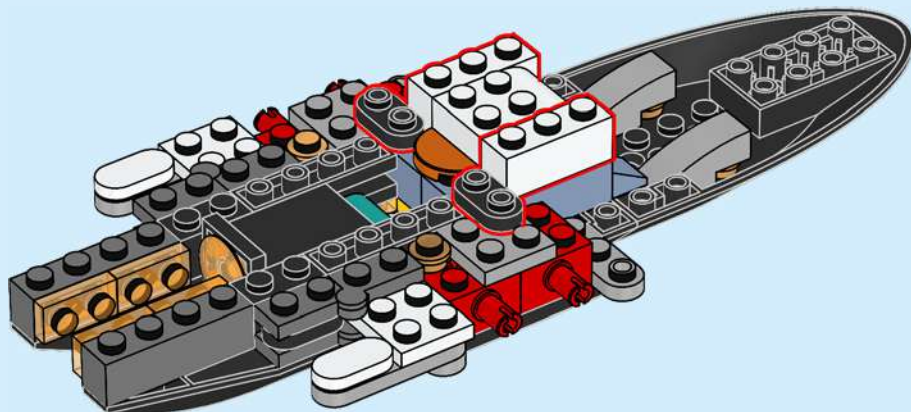



2x

34

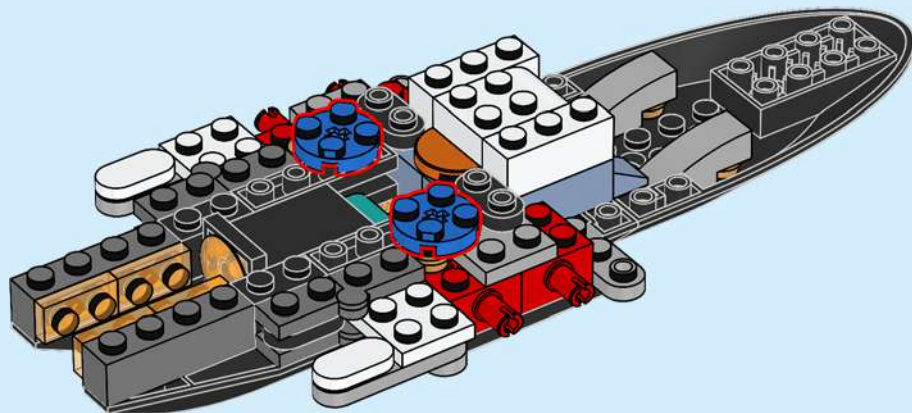

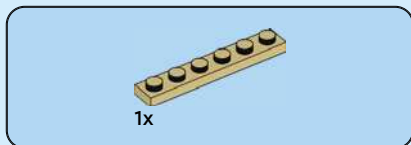

35

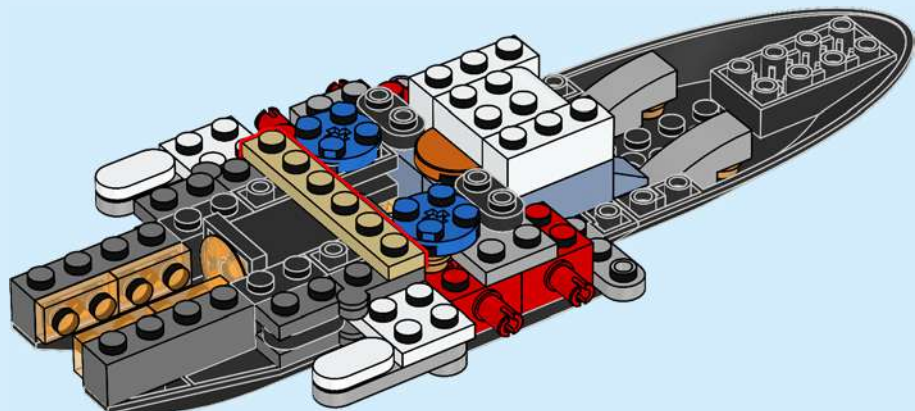



36

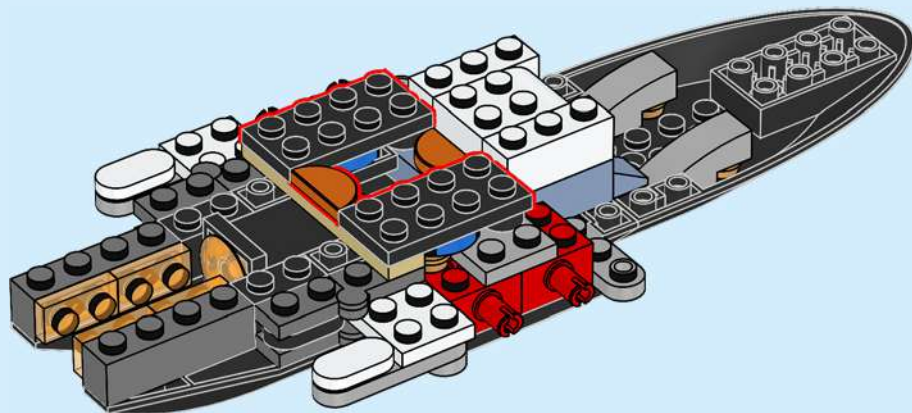



1x

37

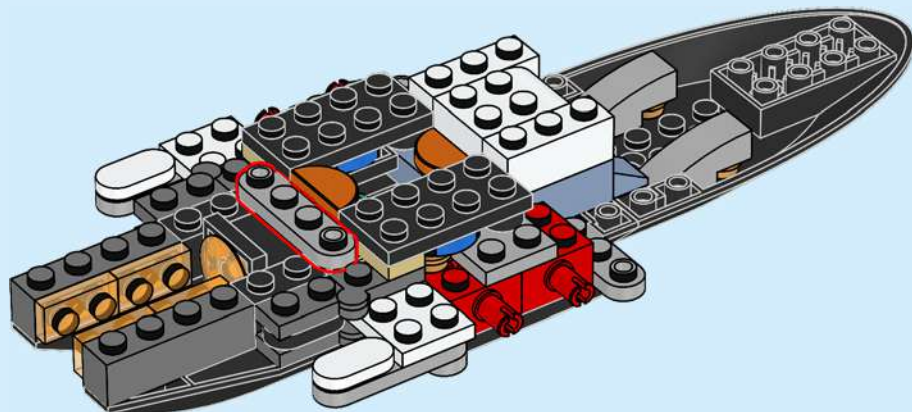



2x

38

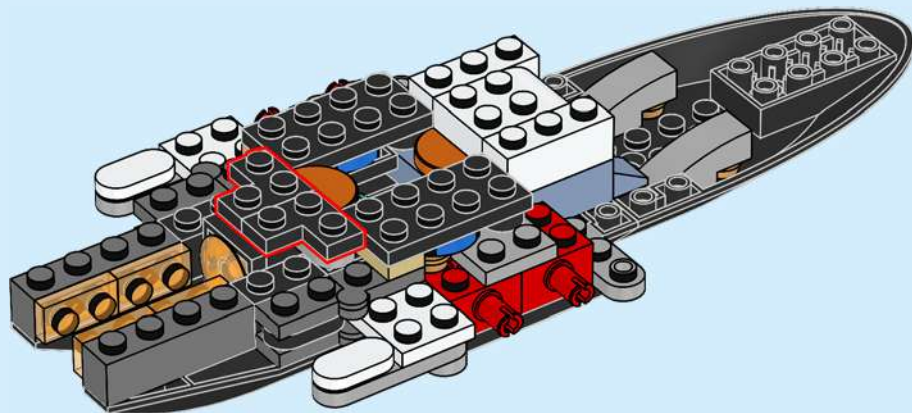



2x

39

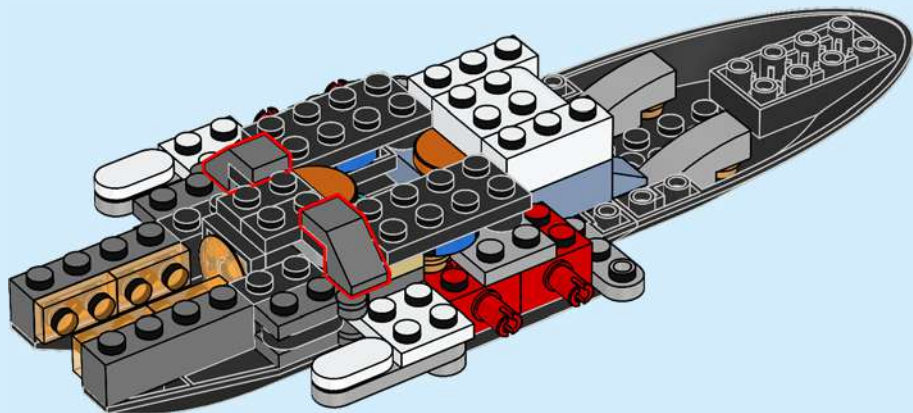

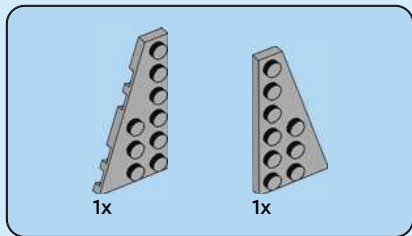

40

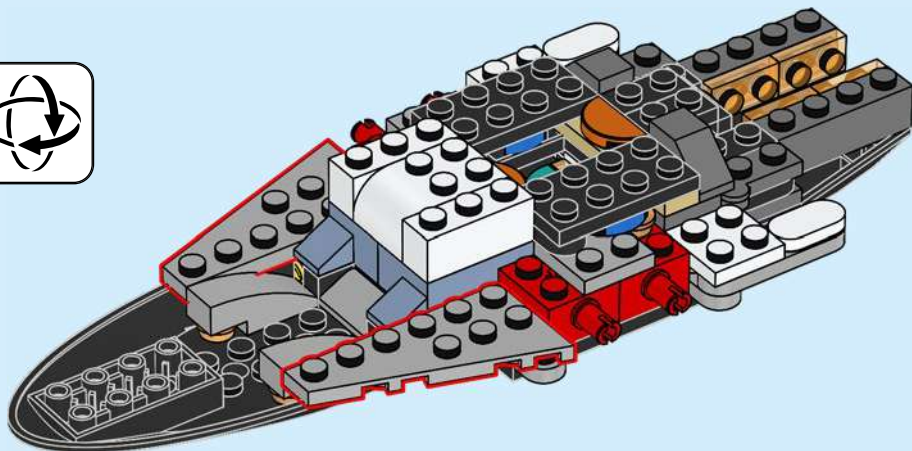

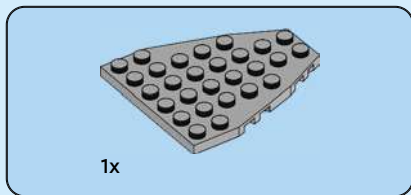

41

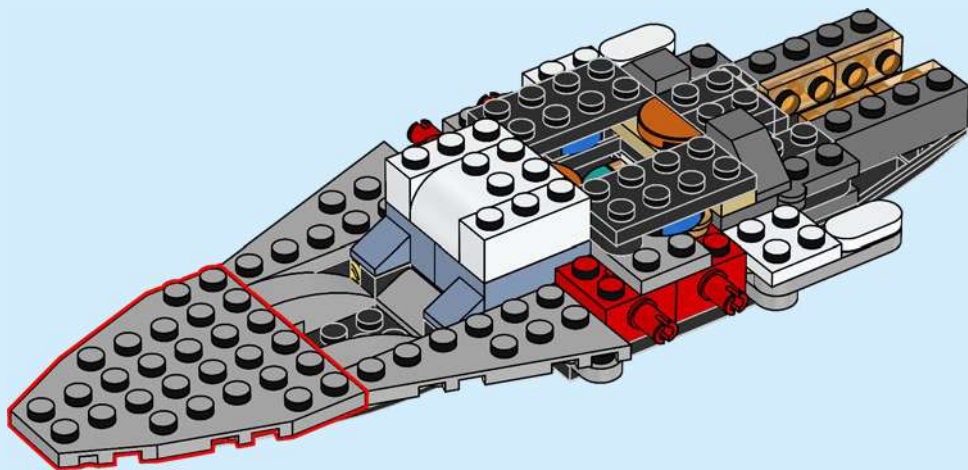



2x

42

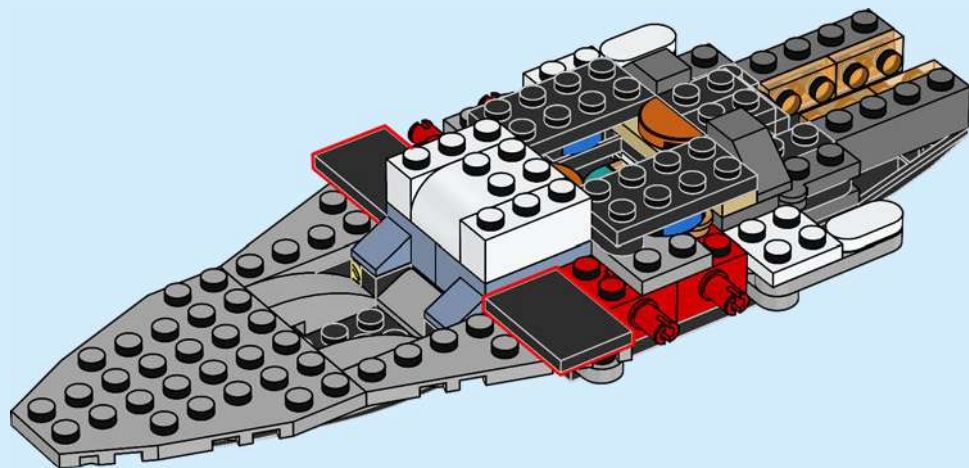

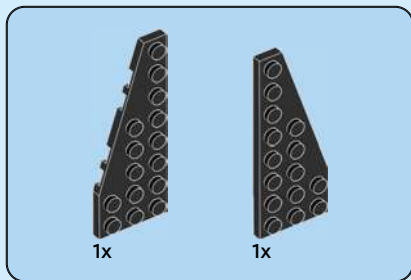

43

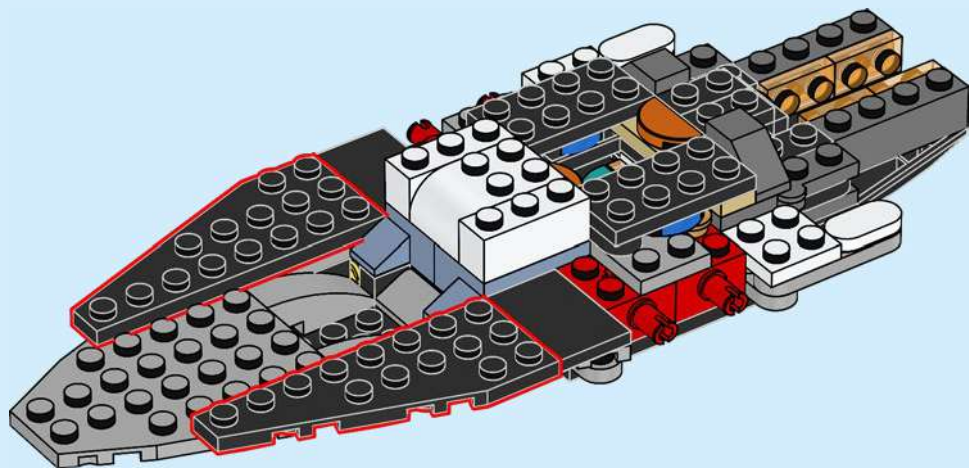



2x

44

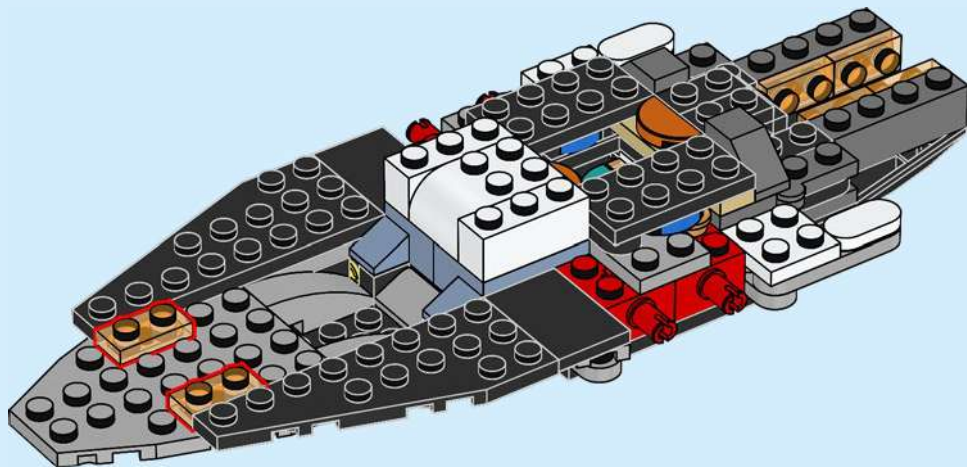



2x



2x

45

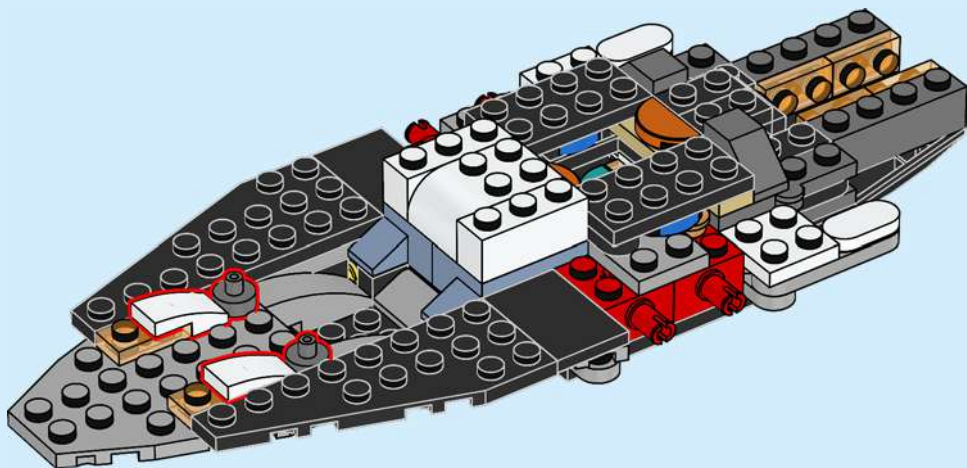

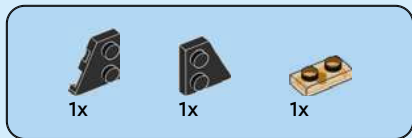

46

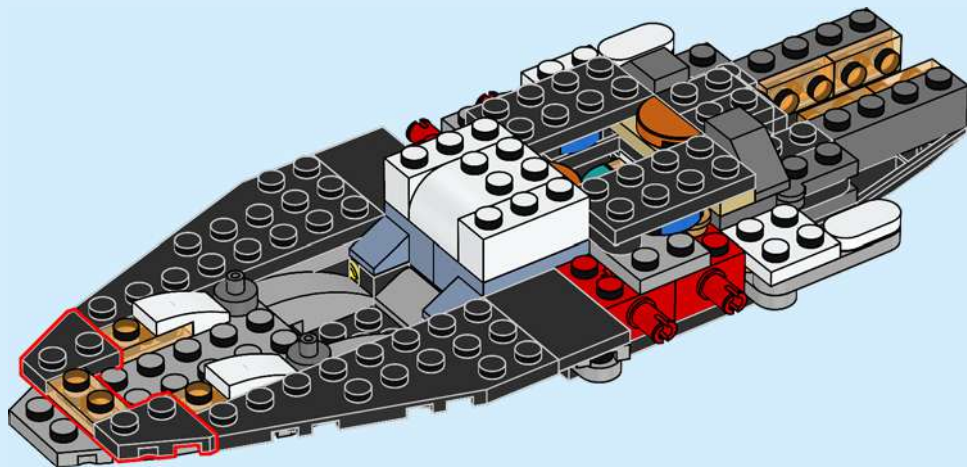



2x

47

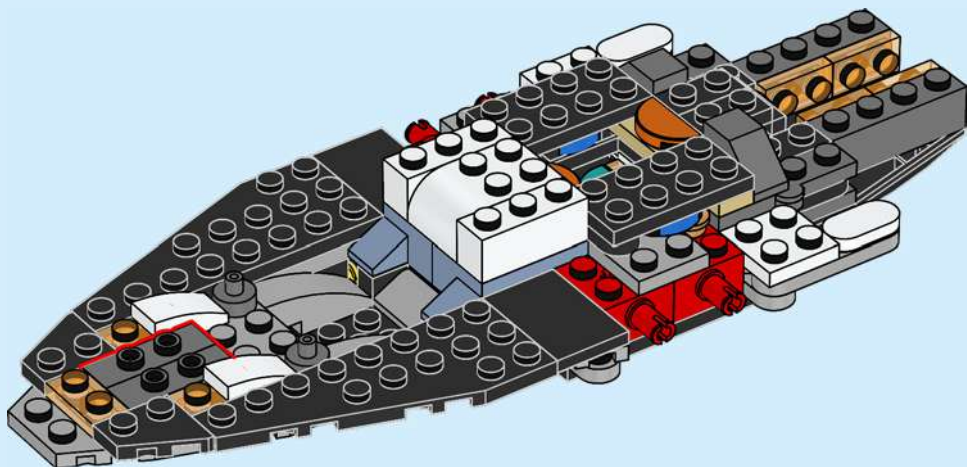



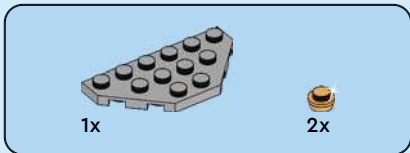

48



49

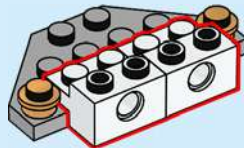

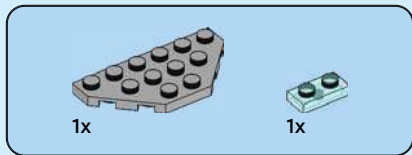

50

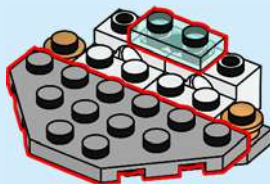
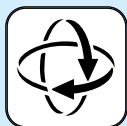



51

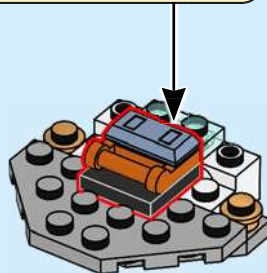
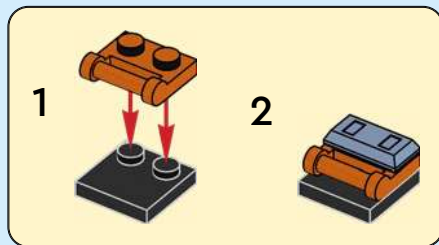



1x

52

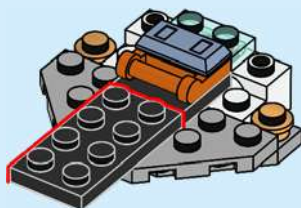

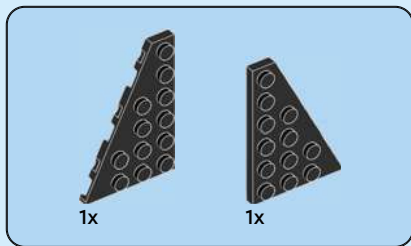

53

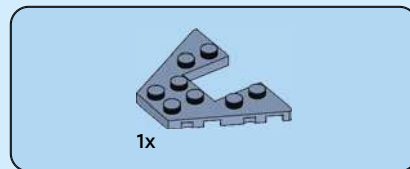
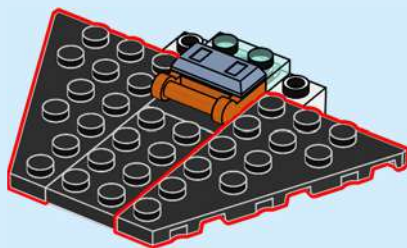

54

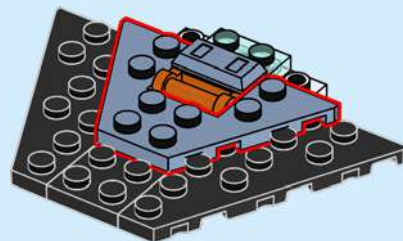

2x

55

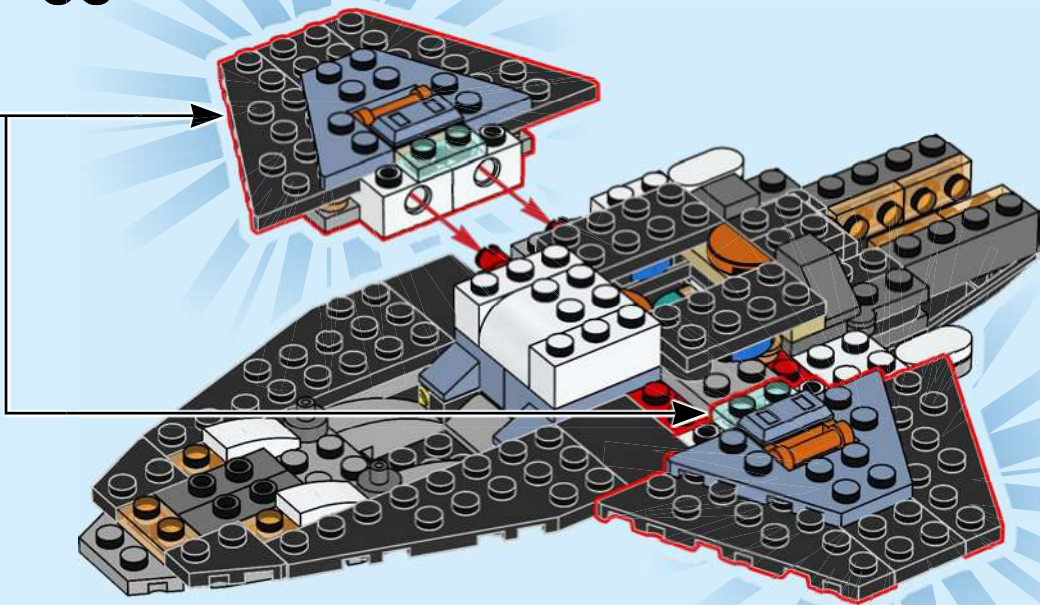

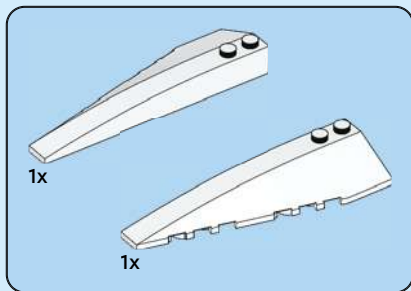

56

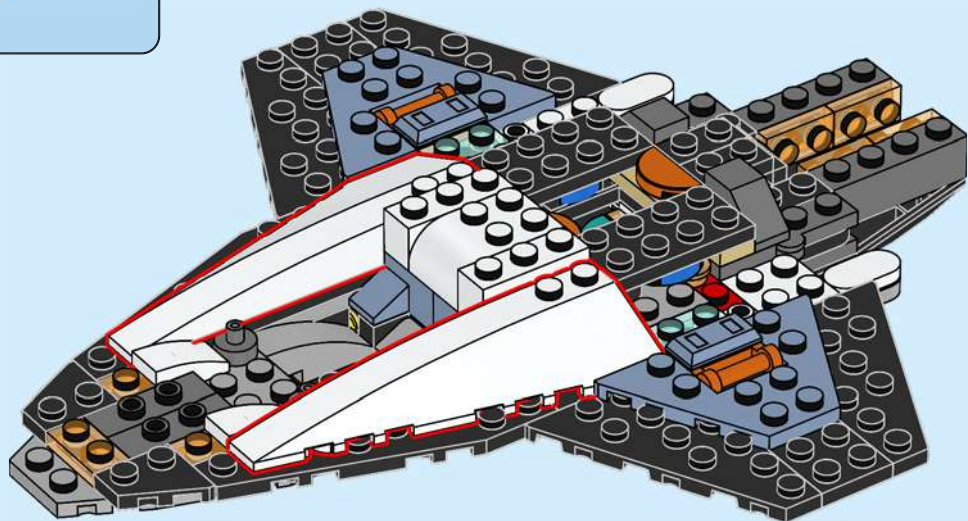



2x

57

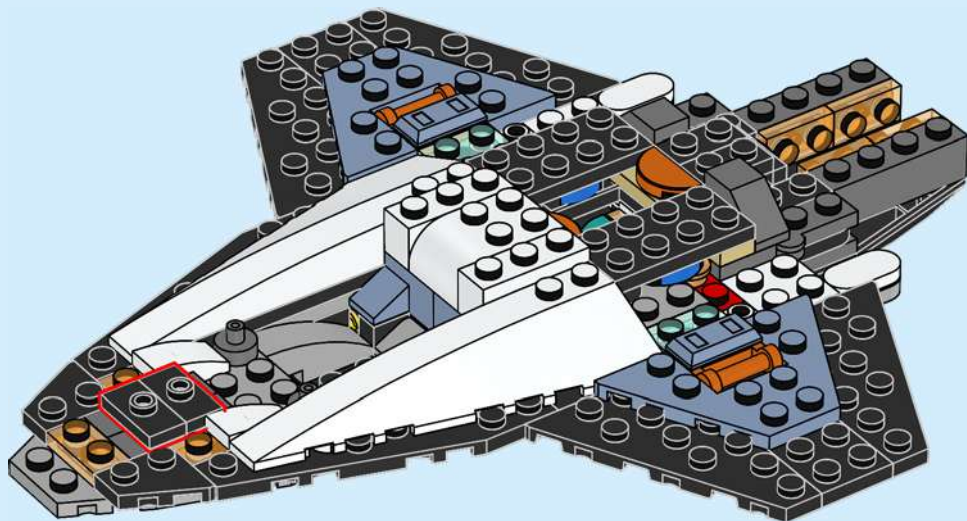



58

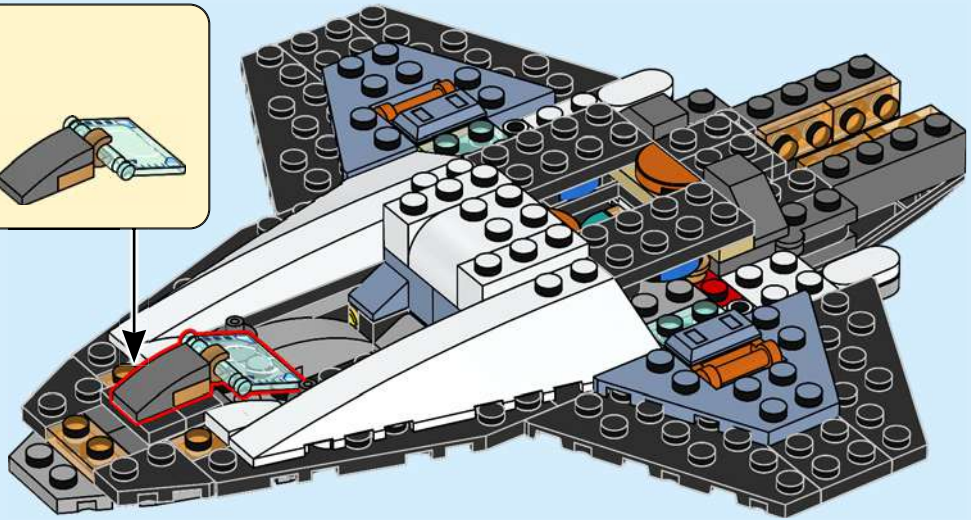
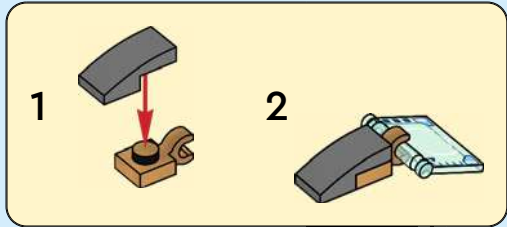



1x



1x

59

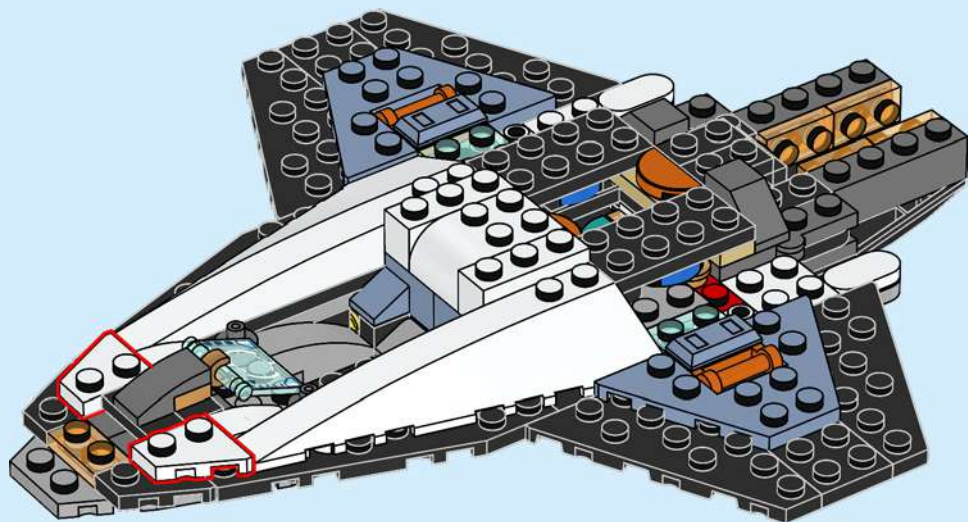



60

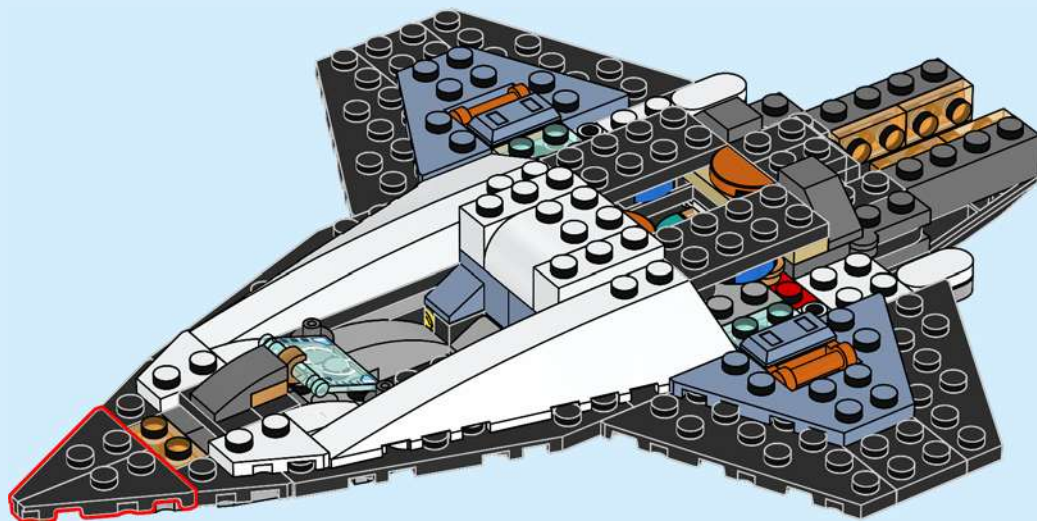

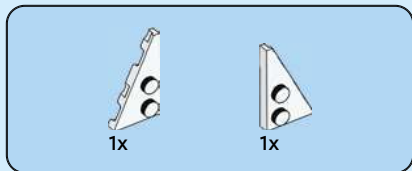

61

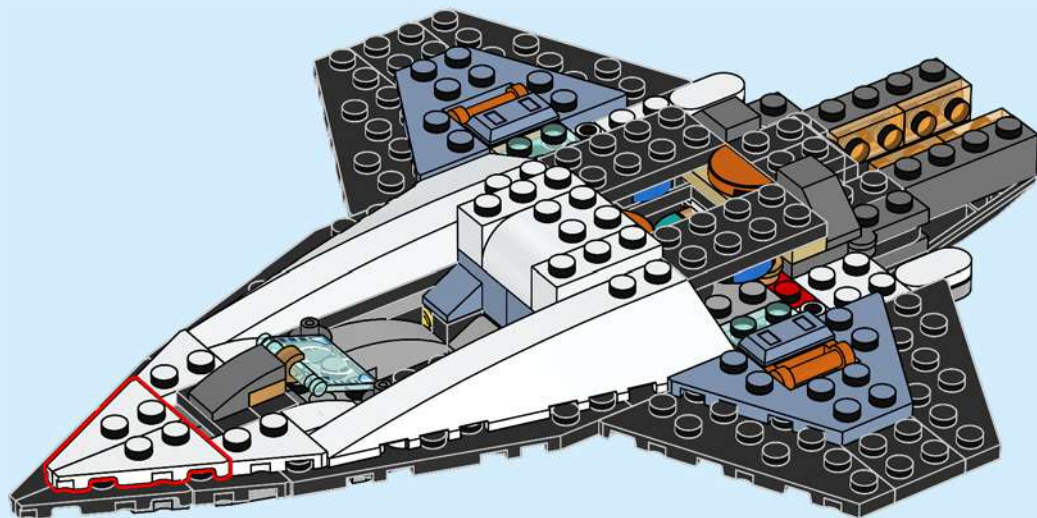



1x



1x

62

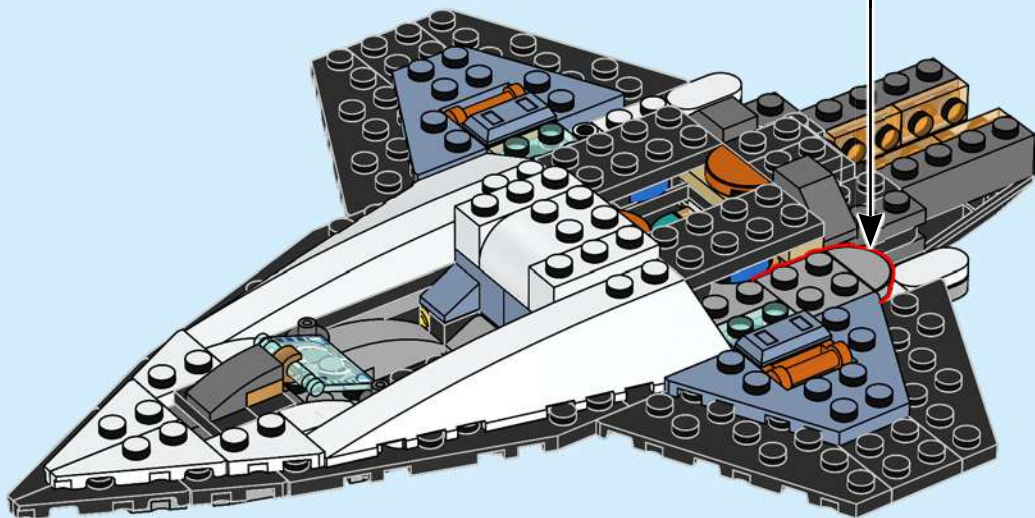



2x

63

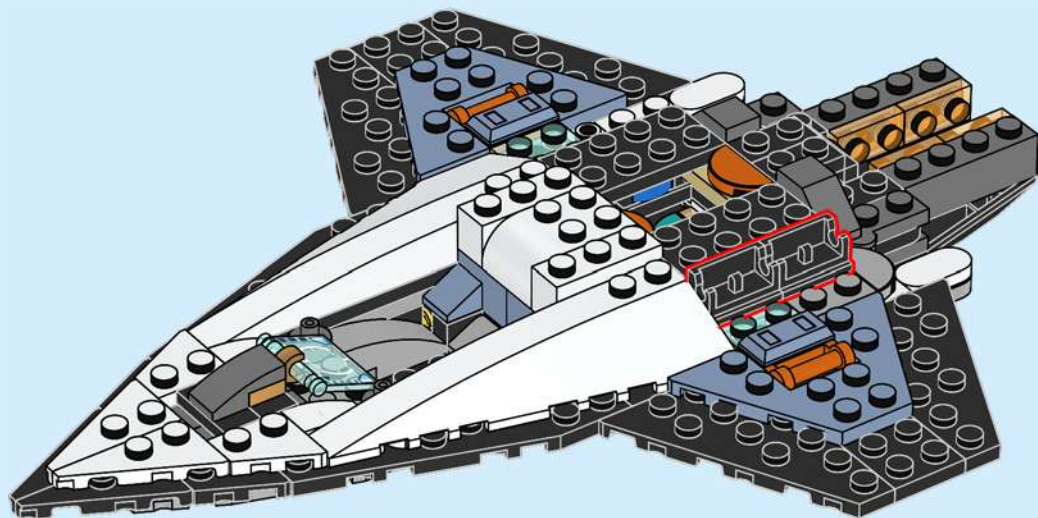



2x

64

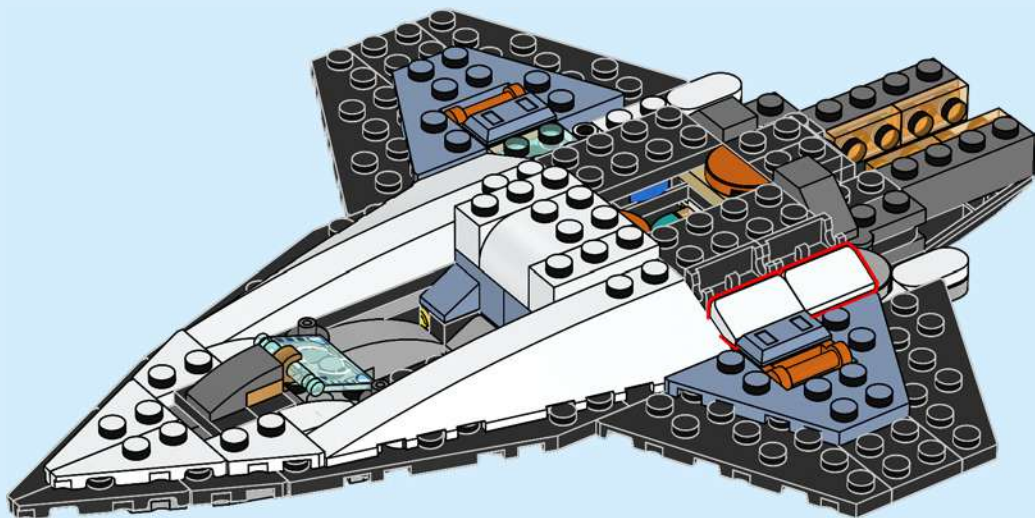



1x



1x

65

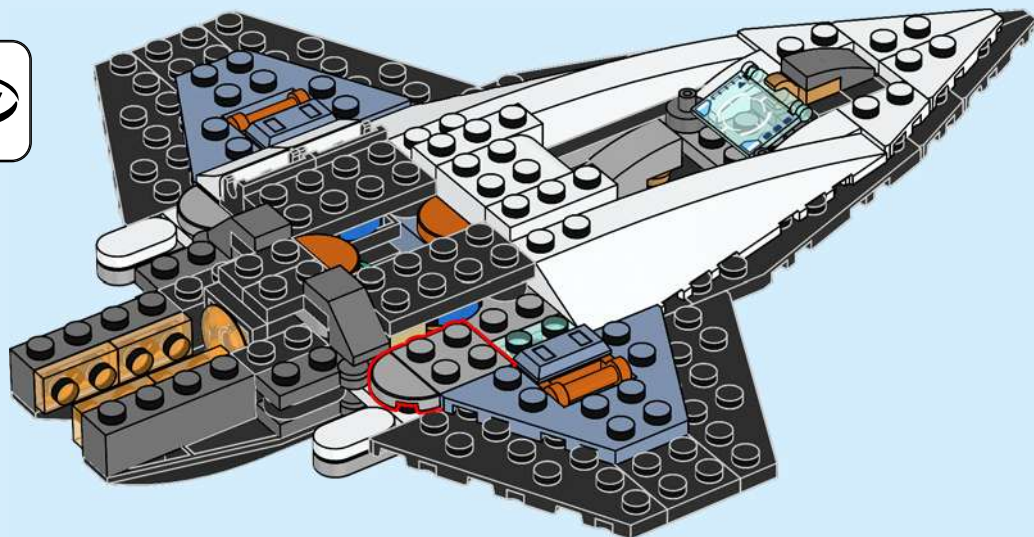



2x

66

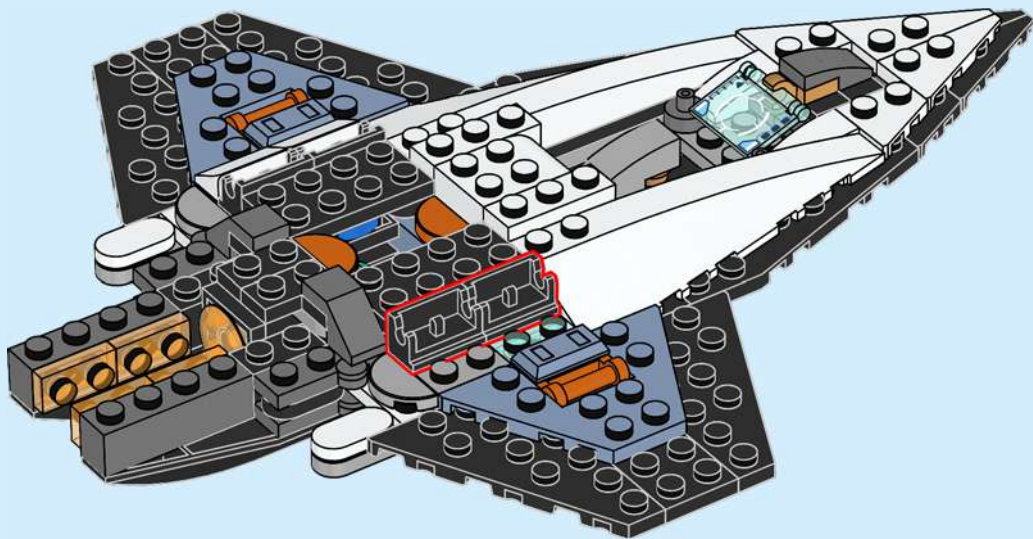



2x

67

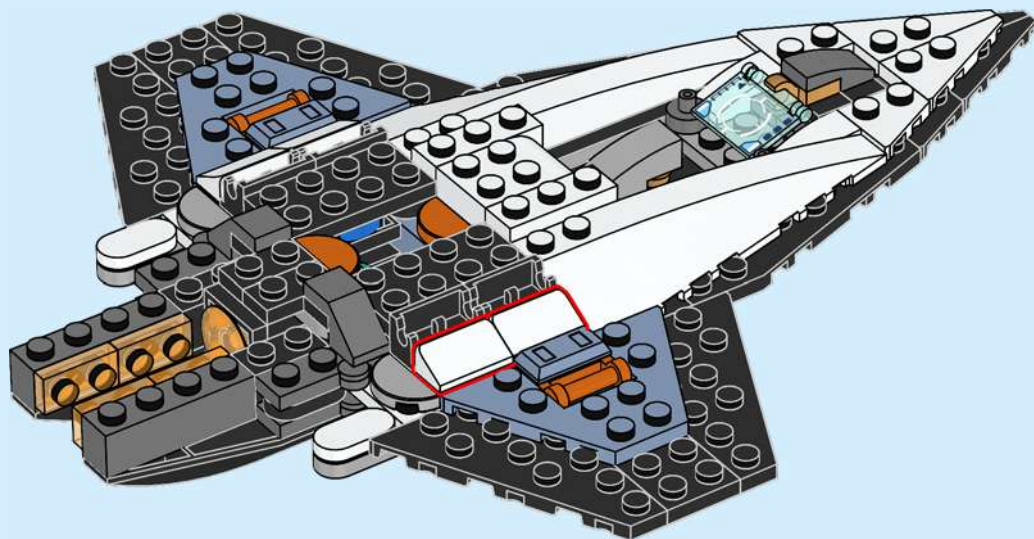



2x

68

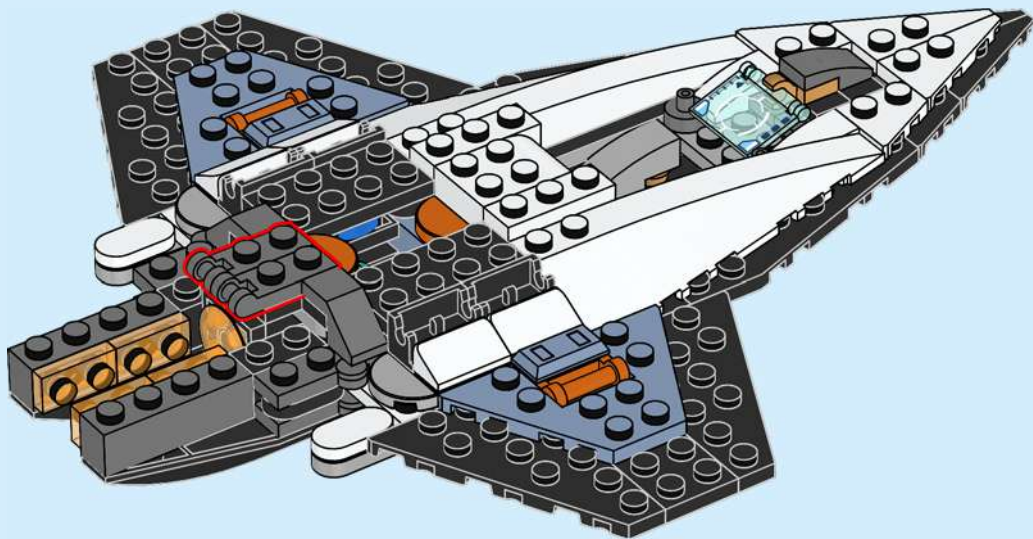

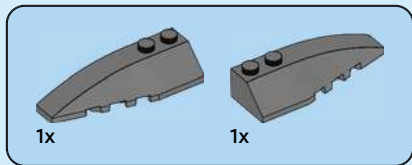

69

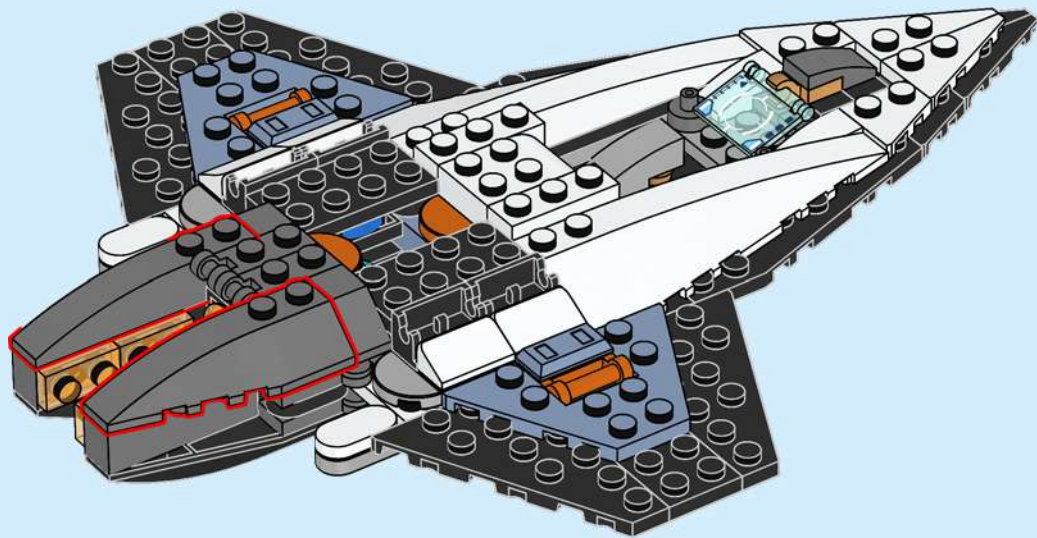

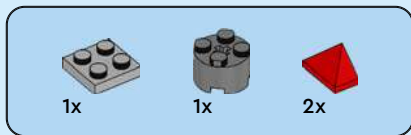

70

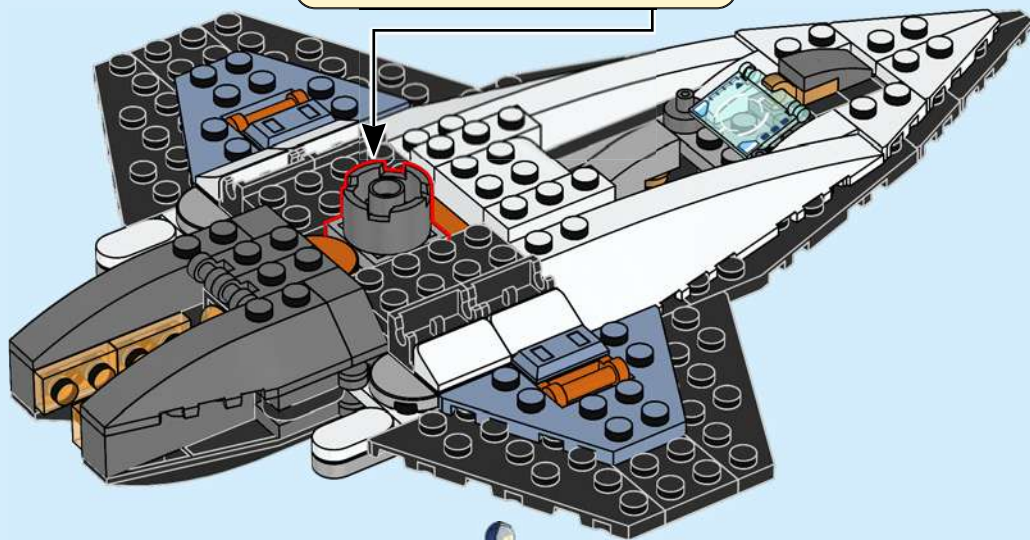
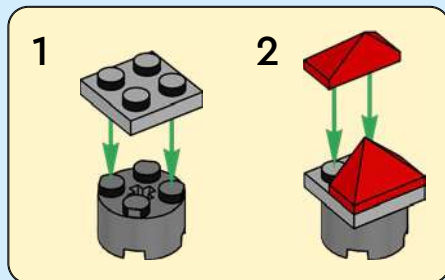



1x

71

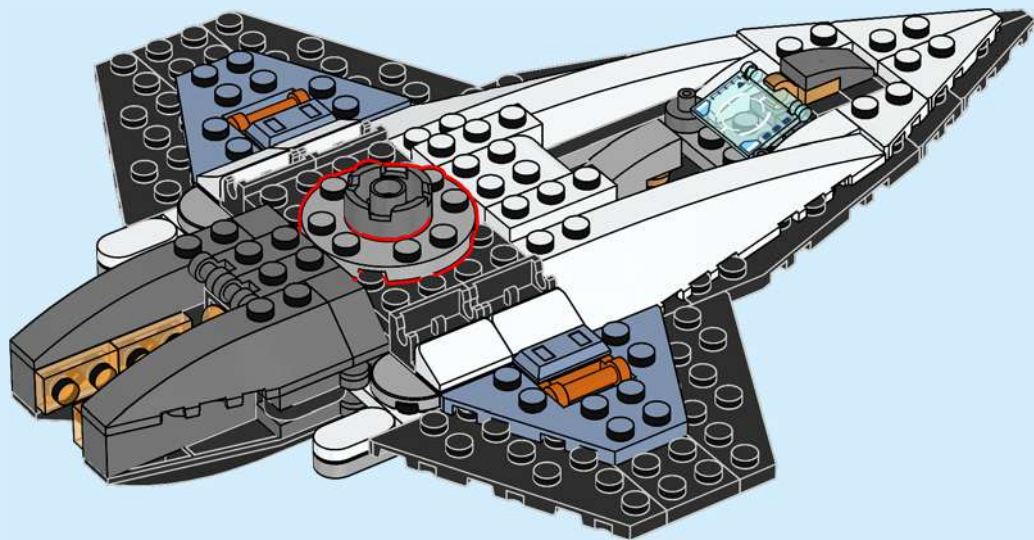

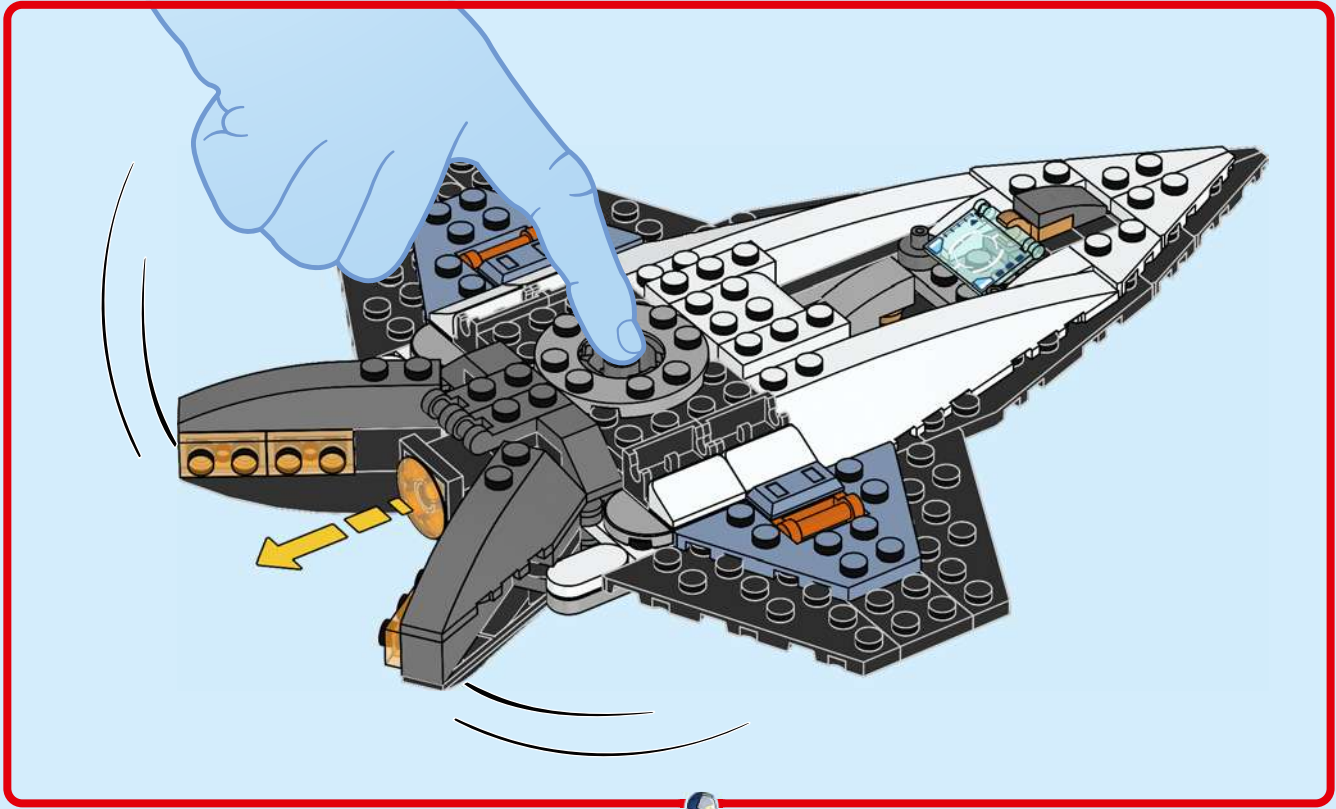



72

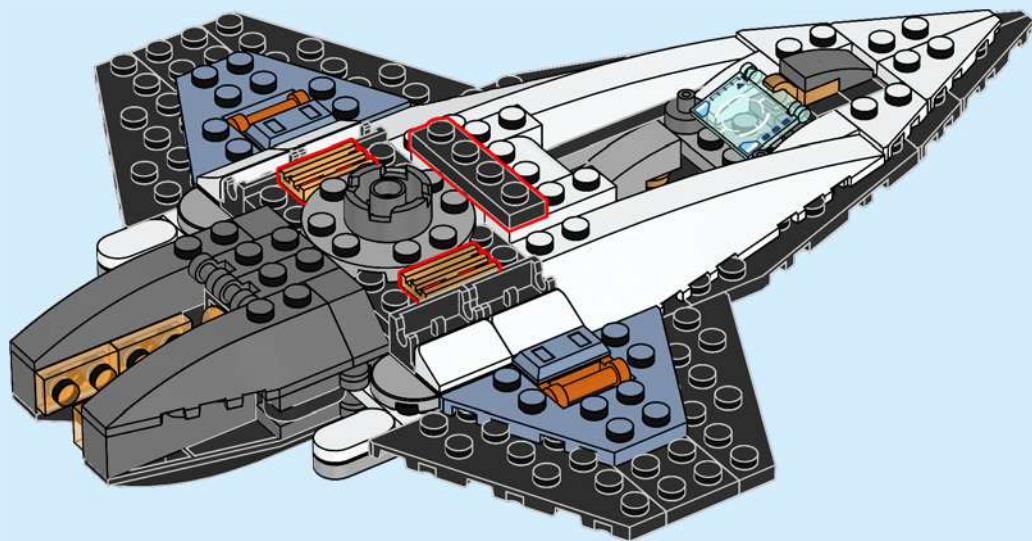



2x

73

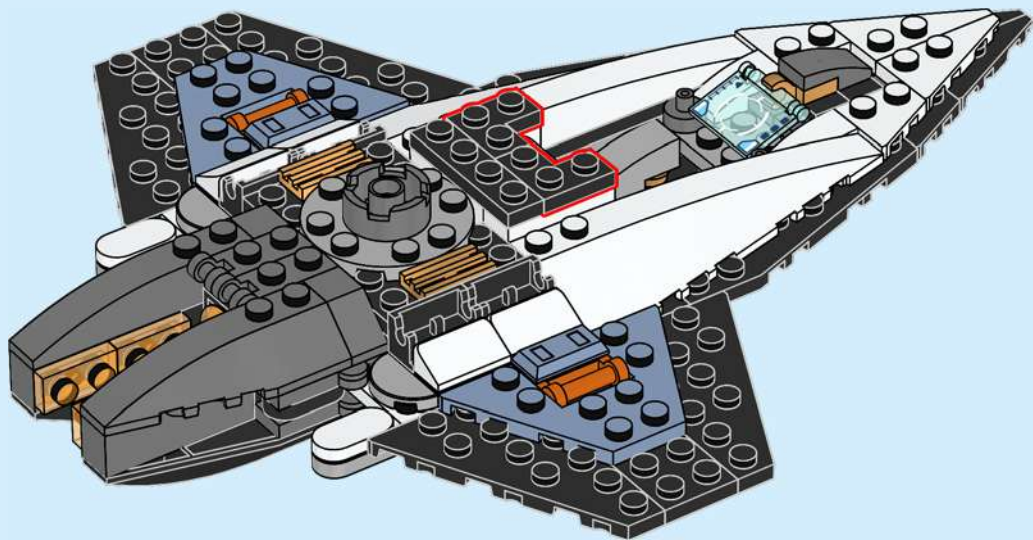

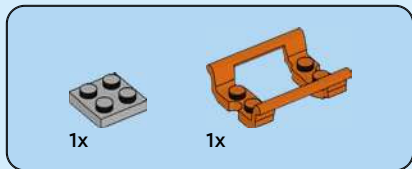

74

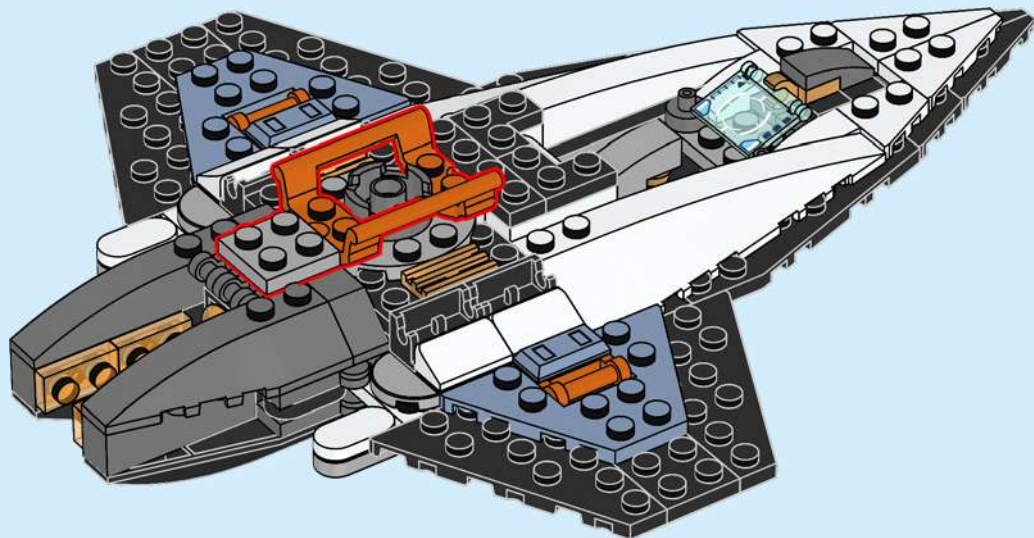

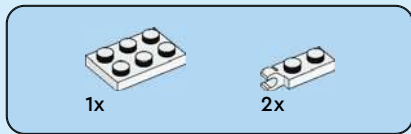

75

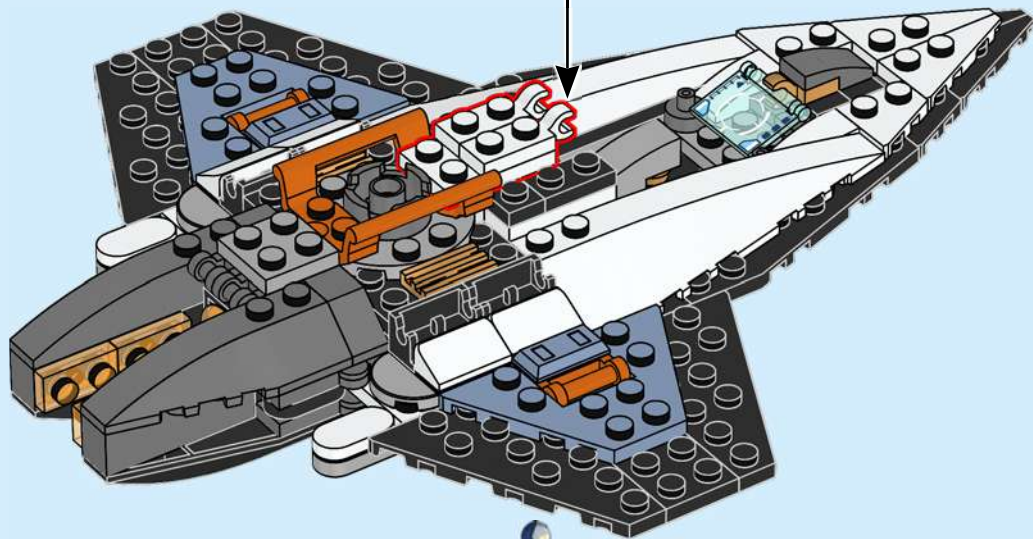
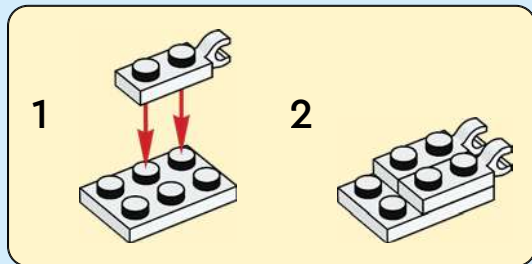



2x

76

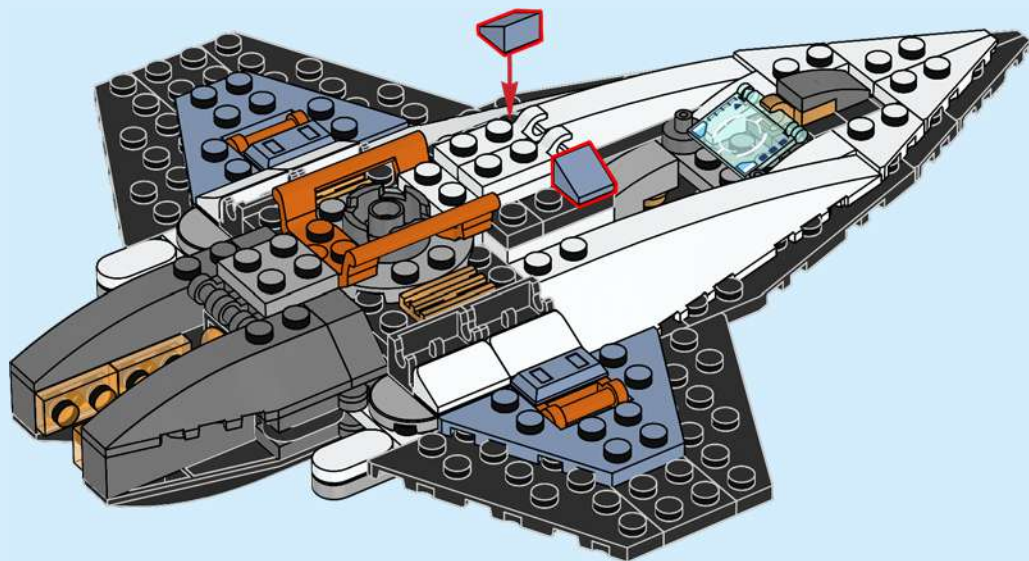



4x

77

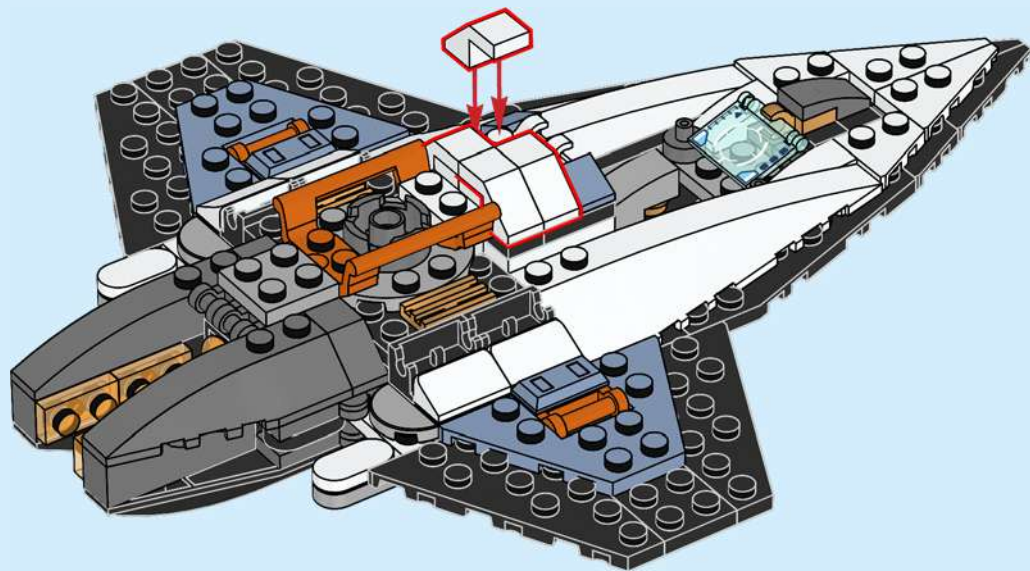

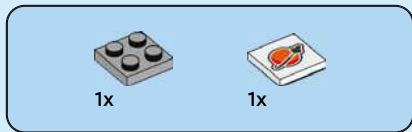

78

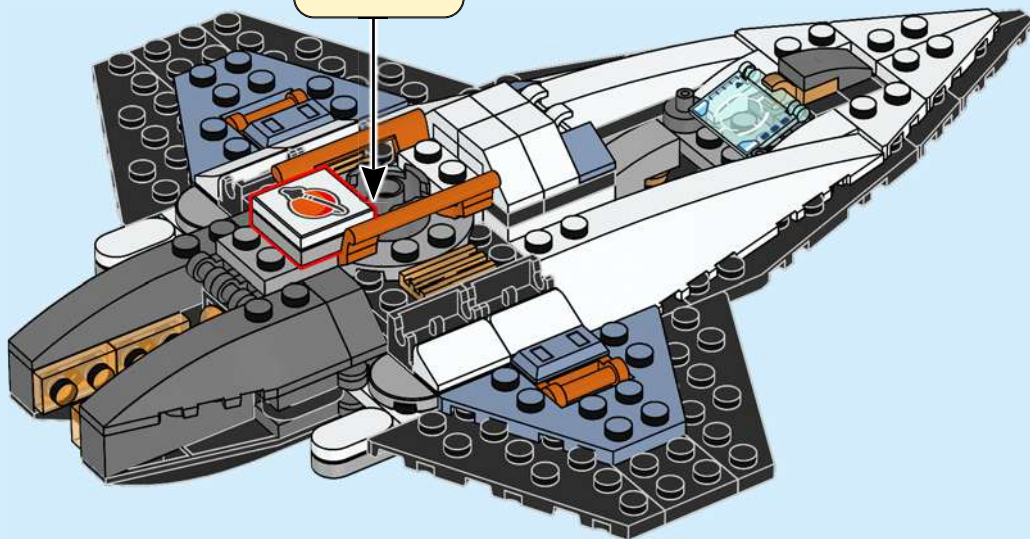
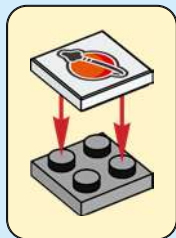



2x

79

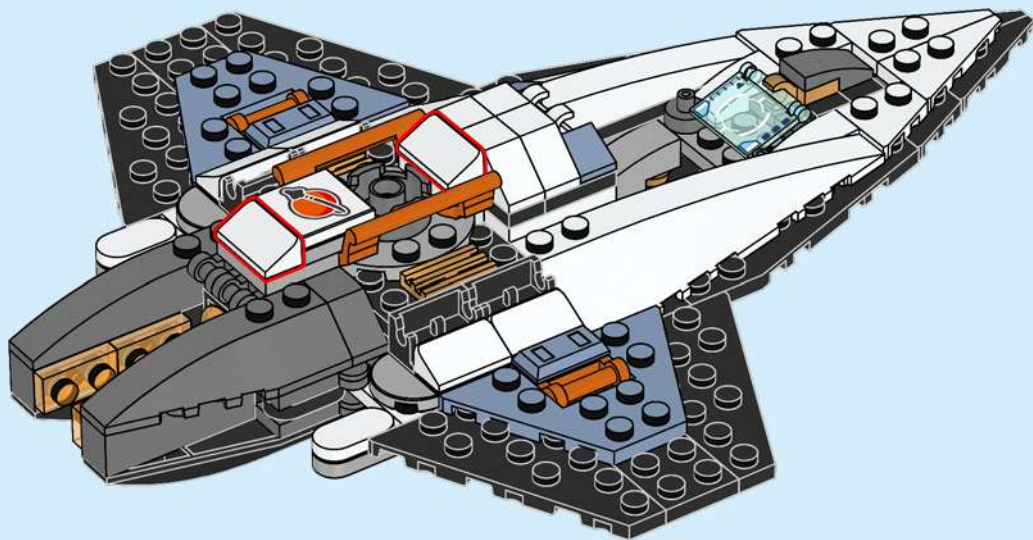



4x

80

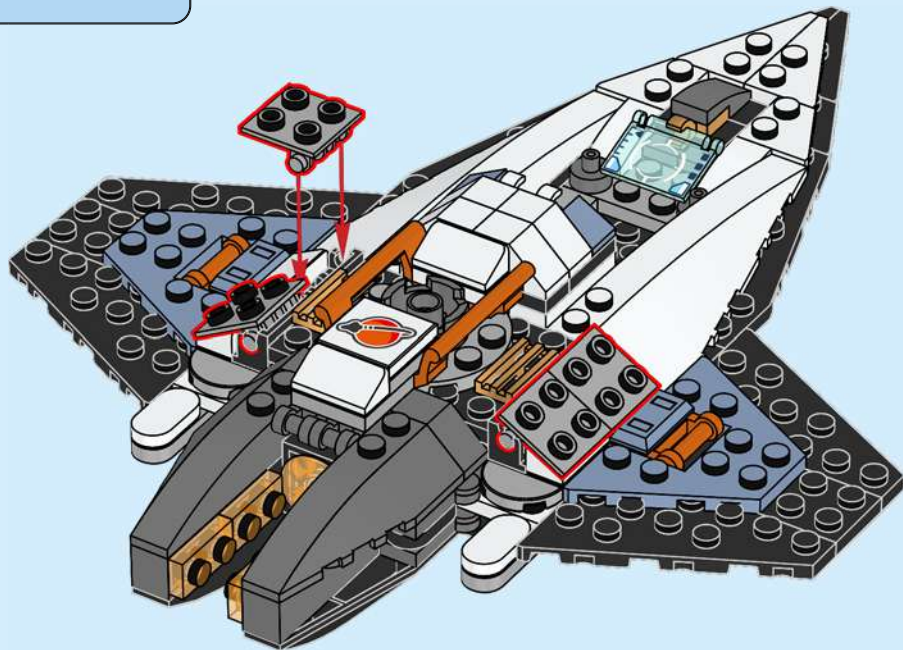

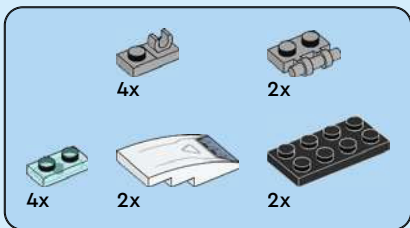
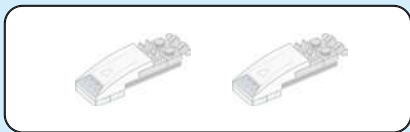

81

1

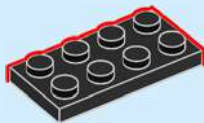

2

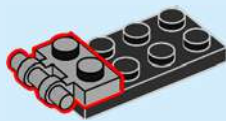

3

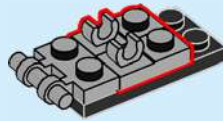

4

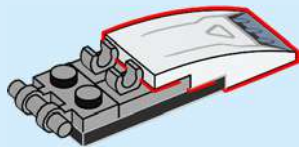

5

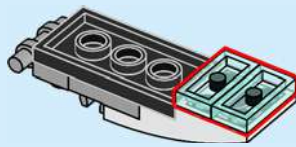

2x

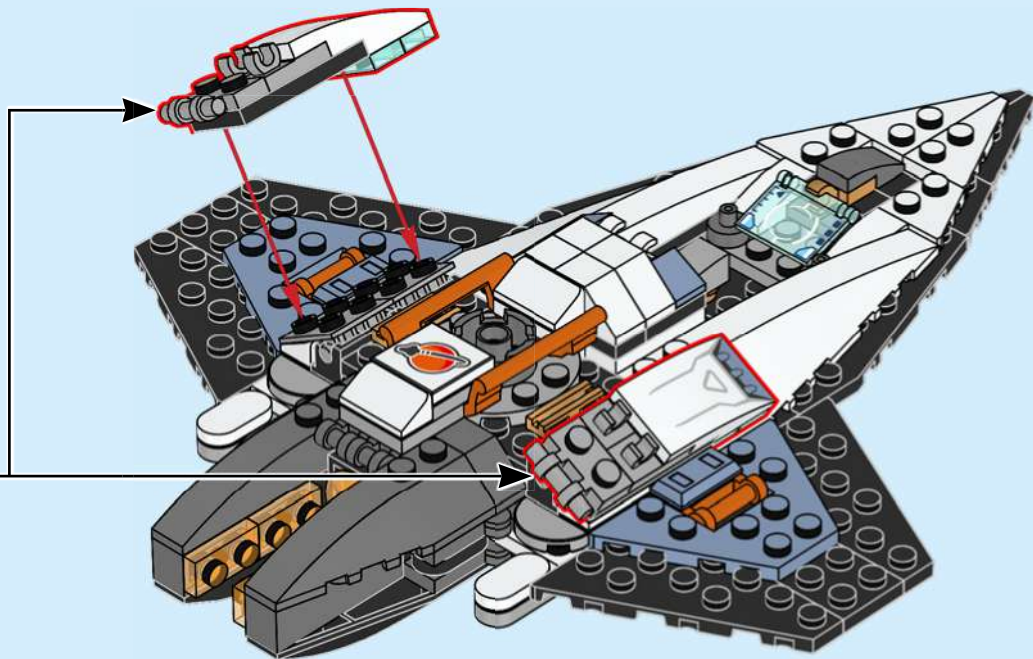



2x

82

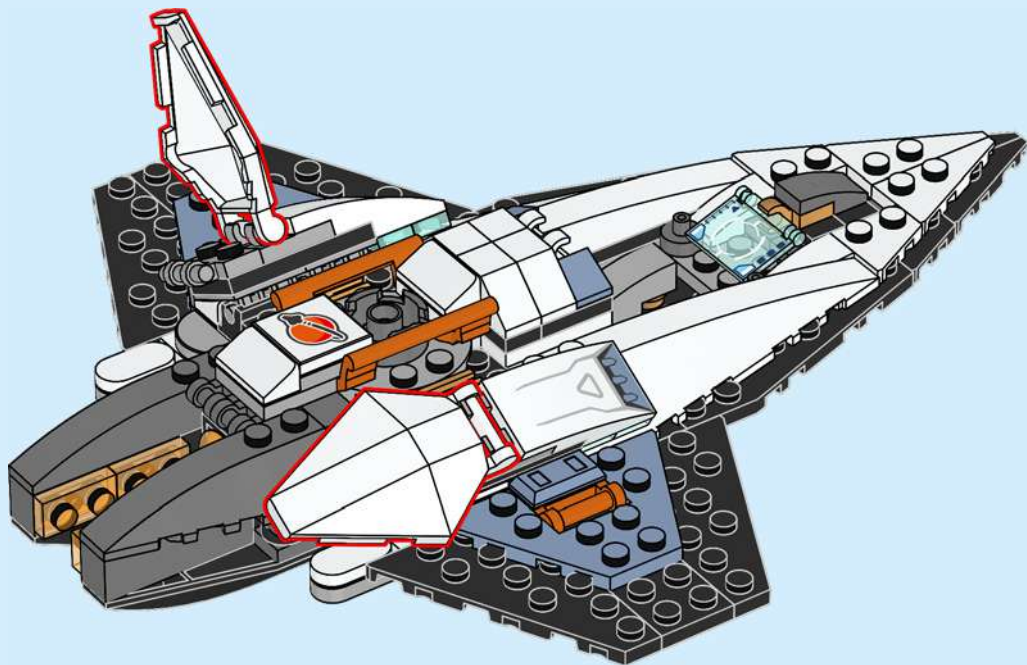

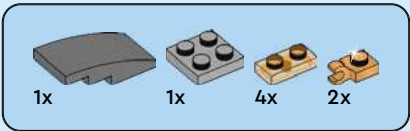

83

1

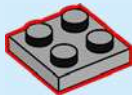

2



3

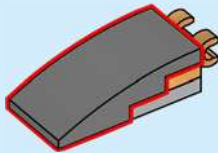

4

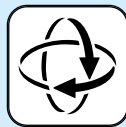

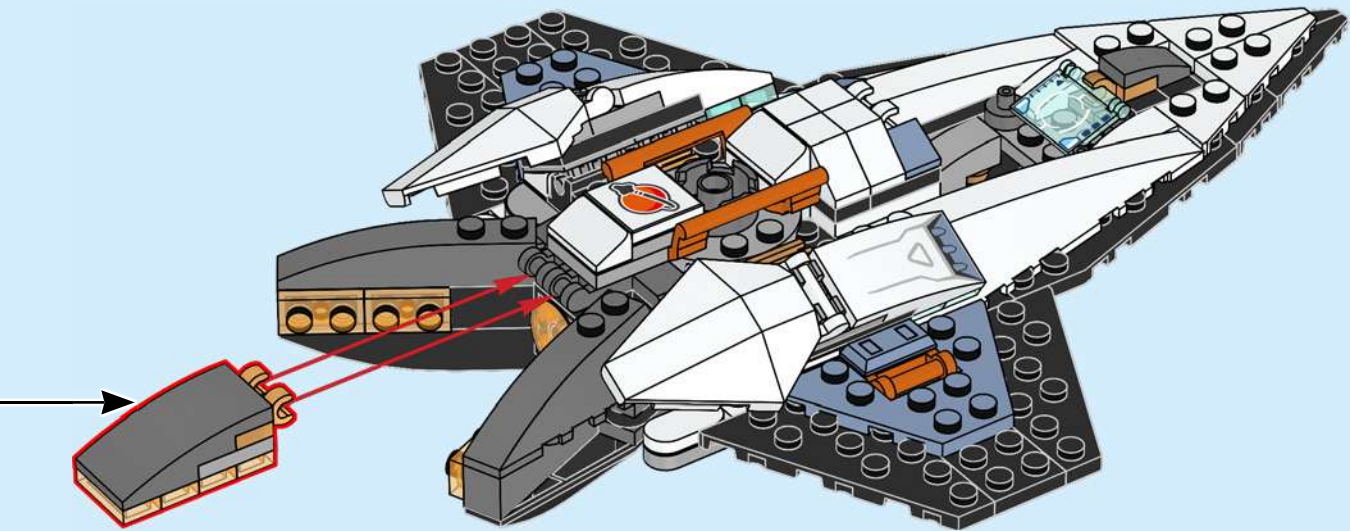

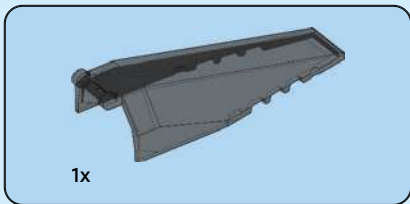

84

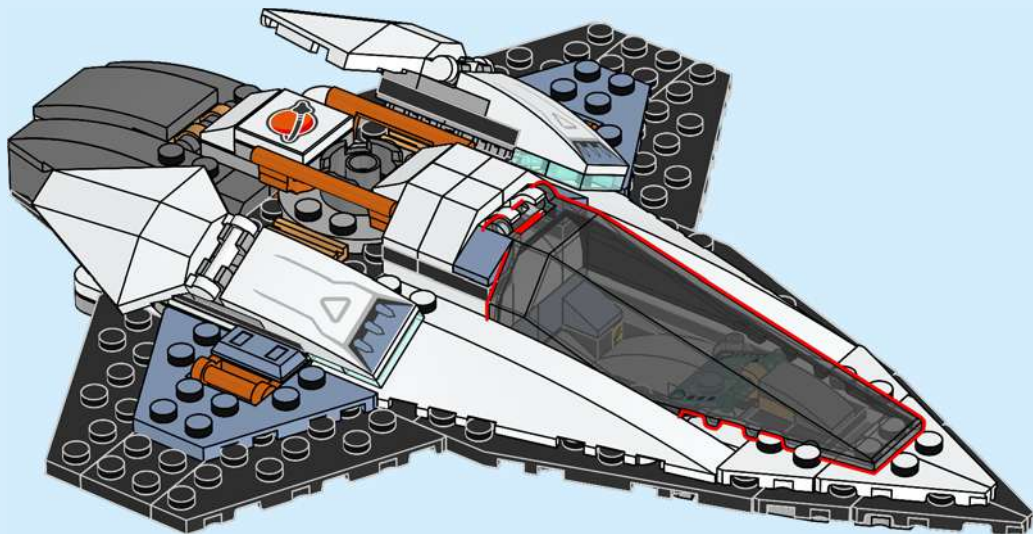

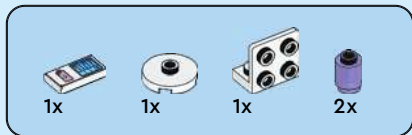

85

1



2



3



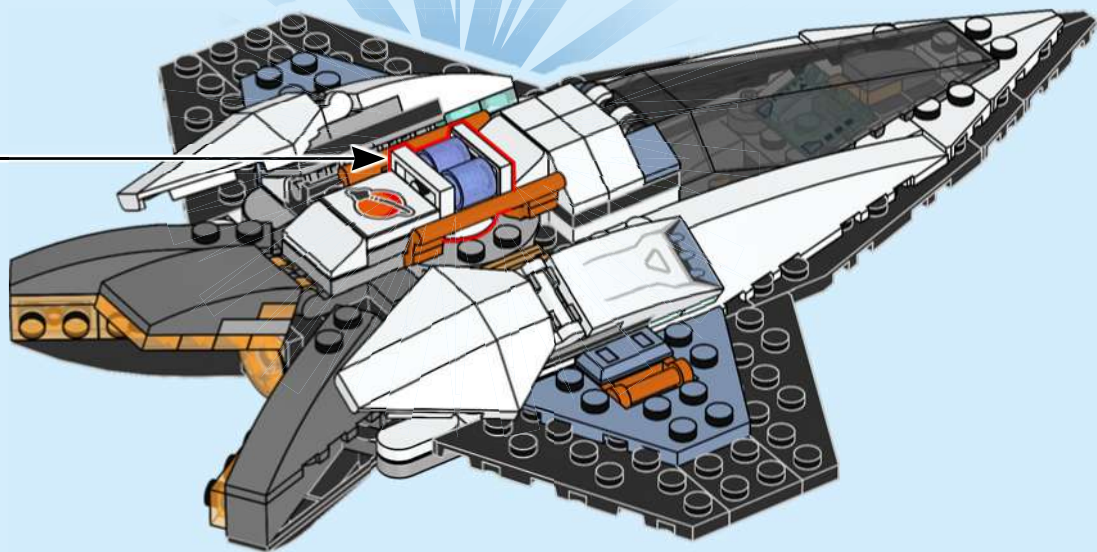

86

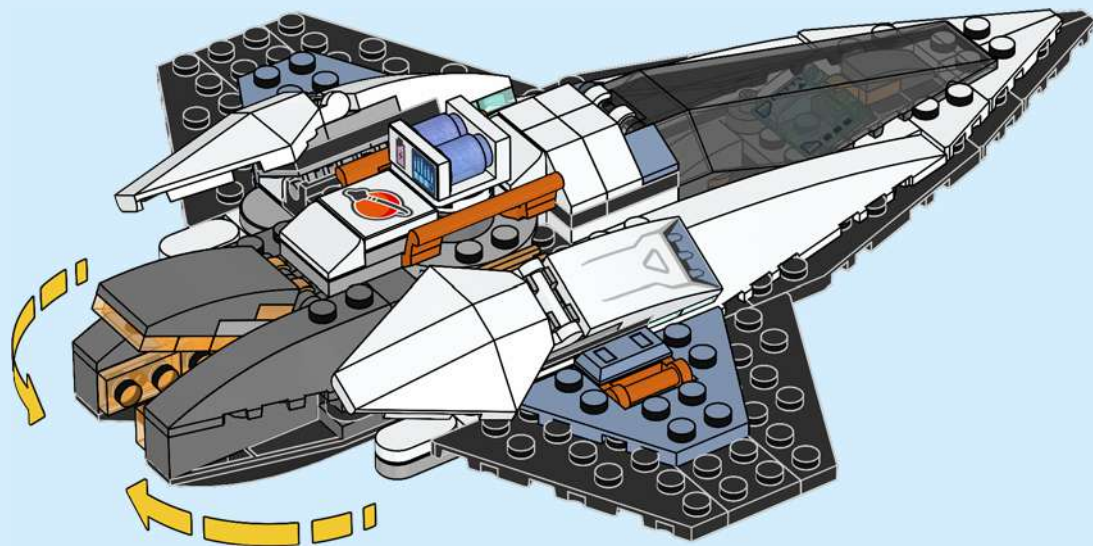

87

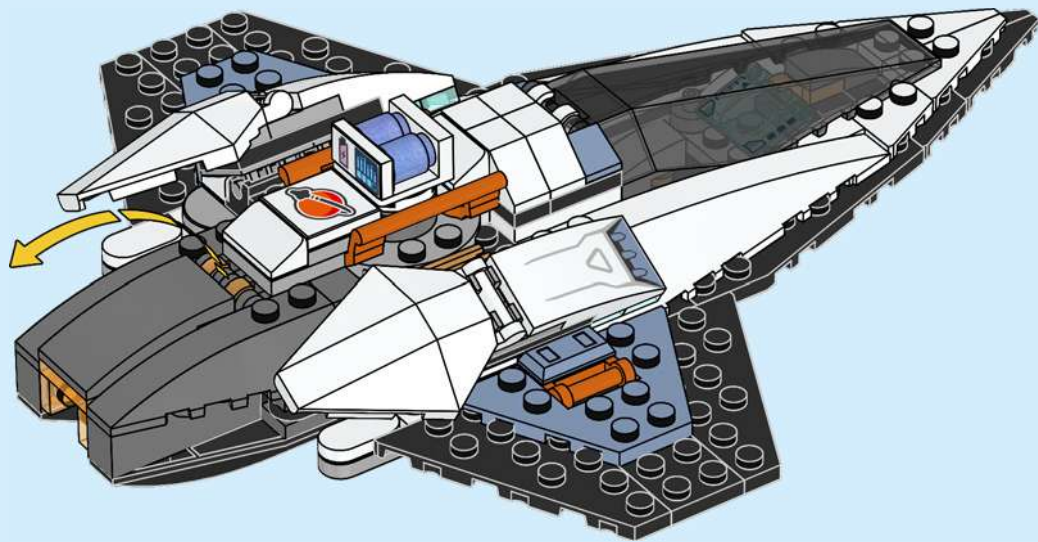

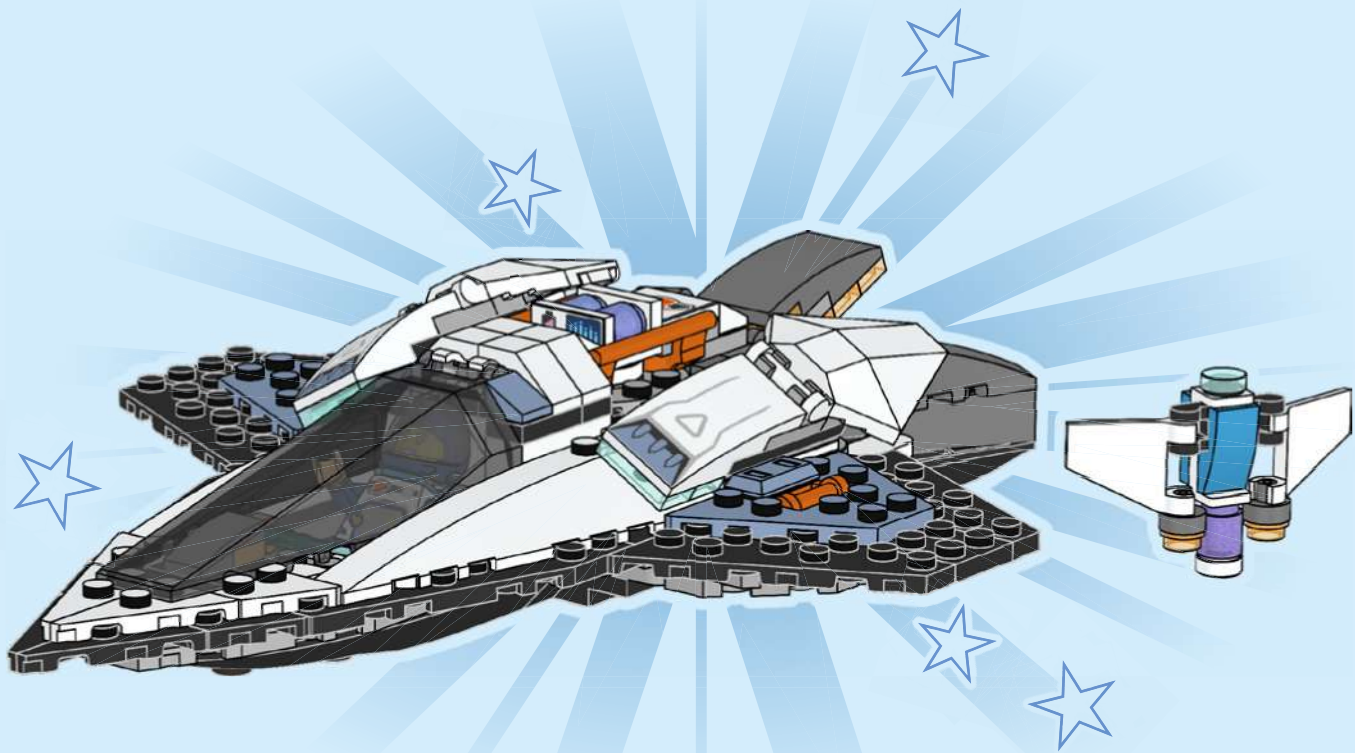



CITY

60430



60433



60434



60431



SPACE

Space
Weltraum
L'espace

Spazio
Espacio
Espaço

太空
Kosmos
Vesmír

Világűr
Spațiu
Kosmos

Kosmos
Erdvė



1x
6465627



2x
6242241



1x
6354823



1x
6132203



2x
6448745



1x
6354822



1x
6132204



6x
4547489



1x
6093053



1x
6465630



4x
6166894



2x
6034044



1x
6097637



2x
4249563



2x
6365500



2x
6361170



1x
6465626



4x
6342970



2x
362201



1x
6475147



4x
302101



1x
621501



2x
6469017



2x
6341902



1x
6015477



1x
6015474



3x
4124067



2x
6075074



4x
6347696



2x
403223



2x
6331822



1x
4218699



1x
6465631



1x
302024



1x
6295295



1x
6141554



1x
6295293



1x
6141556



5x
6210270



2x
300426



4x
393726



2x
6092585



1x
6250020



1x
4251394



1x
4251393



1x
6398391



4x
242026



2x
6192346



2x
6258209



2x
6258214



4x
6162892



1x
371026



2x
265326



6x
302026



1x
6468984



1x
6468980



1x
6472684



1x
6472688



1x
6469829



1x
6274739



1x
6469015



6x
6240222



1x
6466044



4x
6062686



2x
6372479



2x
6406007



2x
6468983



1x
6465624



1x
6475149



2x
6240227



1x
6171727



14x
6240217



2x
6408629



1x
4568637



4x
6326078



2x
4211632



1x
4282789



1x
4282786



9x
4211397



4x
4211881



2x
4251163



7x
6456718



1x
6167798



4x
4211352

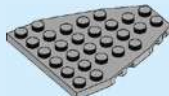

1x
6038296



10x
4523159



3x
6284379



2x
4490599



3x
6464814



4x
6271752



1x
4249139



2x
6168776



1x
6029948



1x
6469463



2x
4521187



2x
6343852



2x
4210725



4x
6416526



1x
6005668



1x
6063685



1x
6063681



1x
6468985

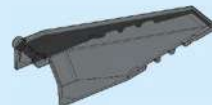

1x
6440101



2x
6474749



2x
6468361



1x
6471481



1x
4653988



1x
6137300



 [LEGO.com/service](https://www.LEGO.com/service)

YOU COULD **WIN**



Scan this QR code or go to
LEGO.COM/PRODUCTFEEDBACK and give us
your short feedback about this LEGO® set for
a chance to win a cool LEGO prize.

Terms and Conditions apply*

EN: YOU COULD WIN. Terms and Conditions apply* **DE: Du könntest GEWINNEN.** Es gelten die Teilnahmebedingungen* **FR: Tu pourrais GAGNER.** Des conditions s'appliquent* **IT: Potresti VINCERE tu.** Termini e condizioni sono applicabili* **ES: Puedes GANAR.** Aplican términos y condiciones* **PT: Poderá GANHAR.** Aplicam-se termos e condições* **ZH: 轻松获奖. 条款和条件适用*** **PL: Szansa na WYGRANĄ.** Obowiązują warunki korzystania* **CS: Máte šanci VYHRÁT.** Platí všeobecné smluvní podmínky* **SK: Máte šancu VYHRAŤ.** Platia všeobecné zmluvné podmienky* **HU: TE IS NYERHETSZ.** Felhasználási feltételek érvényesek* **RO: Ai putea CÂȘTIGA.** Se aplică termenii și condiții* **BG: Можете да СПЕЧЕЛИТЕ.** Има определени правила и условия* **LV: Tu vari LAIMĒT.** Ir spēkā noteikumi un nosacījumi.* **ET: Sul on võimalus VÕITA.** Kehtivad tingimused* **LT: Jūs galite LAIMĖTI.** Taikomos sąlygos*

*[LEGO.com/productfeedback-terms](https://www.lego.com/productfeedback-terms)

LEGO and the LEGO logo are trademarks of the LEGO Group. ©2024 The LEGO Group.

6492832