



Q LEGO® Builder

Booklet available in English on
Heft in deutscher Sprache erhältlich auf
Livret disponible en français sur
Libretto disponibile in italiano su
Folleto en español disponible en
如需中文版手册, 请访问





LEGO.com/sustainable-packaging



FR

DONNEZ
OU
RECYCLEZ



ASSOCIATION

OU



MAGASIN

OU



DÉCHÈTERIE

Adresses sur quefairedemesdechets.fr



BUiLDER



Apple and the Apple logo are trademarks of Apple Inc., registered in the U.S. and other countries and regions. App Store is a service mark of Apple Inc. Google Play and the Google Play logo are trademarks of Google LLC. Tencent and the Tencent logo are trademarks of Tencent Inc.

Q [LEGO.com/devicecheck](https://www.lego.com/devicecheck)



Q LEGO® Builder



Meet the fan designer

Marc Corfmat (LEGO® Ideas name Minibrick Productions) is a mechanical engineering student from California. When he's not busy studying, he loves LEGO building, travelling and playing video games with friends.

"LEGO sets have always been a part of my life. I actually got the idea for the Polaroid model whilst on vacation in La Rochelle, France, where my siblings and I spent most of our childhood summers at our grandparents' house. My brother Nicolas and I would go buy LEGO sets at the local toy shop and play with them non-stop for days."

"My biggest hobby is definitely designing custom LEGO models."

- Marc Corfmat

“My friends and family played a big role in inspiring this model. My sister and many of my friends love to decorate their walls with instant photos. Additionally, I’ve always loved the design of the Polaroid OneStep SX-70. It’s incredibly iconic and still referenced everywhere. I am extremely happy that the final model has kept the functionality for taking pictures. It’s such a great play feature, and I love that my sister and the La Rochelle harbour are featured in one of the ‘photographs’ in this set. I hope builders will find ways of expressing their own creativity with the model. Thank you to everyone who supported this project!”



Marc's original model of the Polaroid OneStep SX-70

The legacy of the Polaroid Corporation

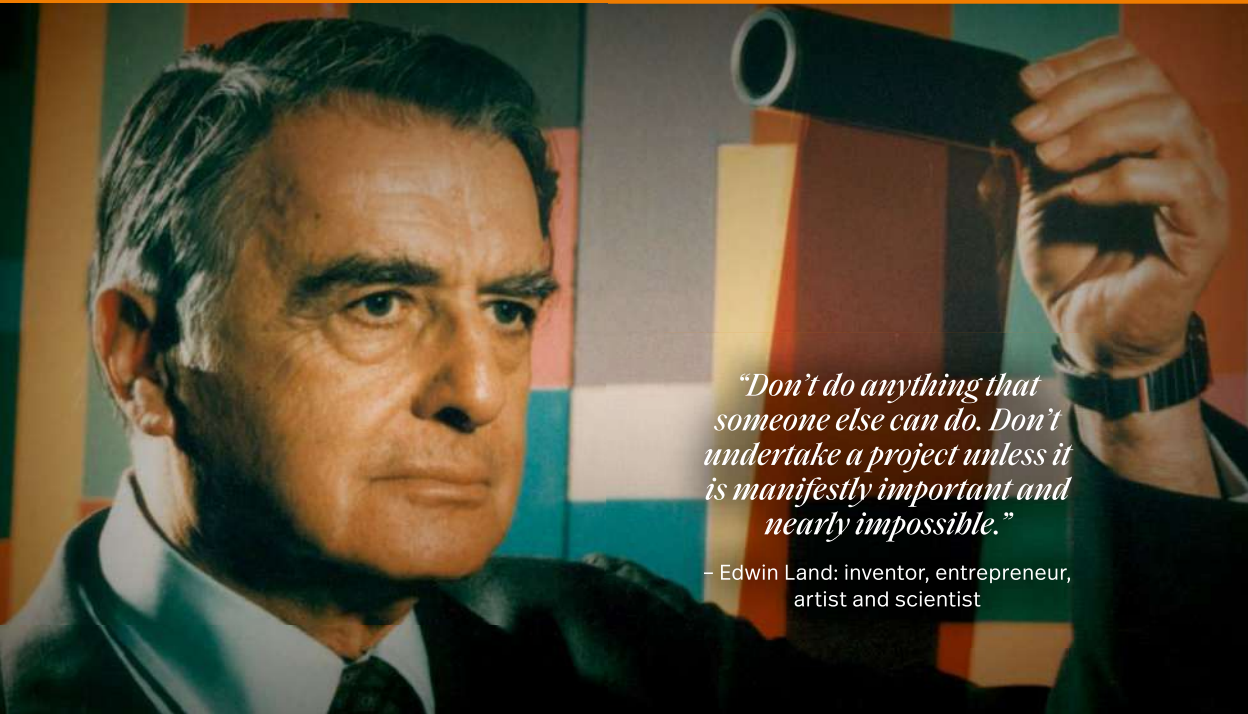

*“Don’t do anything that
someone else can do. Don’t
undertake a project unless it
is manifestly important and
nearly impossible.”*

– Edwin Land: inventor, entrepreneur,
artist and scientist

Courtesy Photo by JJ Scarpetti, courtesy of The Rowland Institute at Harvard

The thought of waiting for days or even weeks from the time you snap a picture until you can see it is either completely foreign to some, or a faint memory to others. Today, we can share photos with our loved ones or the entire world in a matter of seconds. But instant digital photography actually descends from a long line of technology and innovations pioneered by one of the great visionaries of the 20th century - Edwin H. Land (1909-1991).

A curious scientist and engineer by nature, Land began working on his first inventions when he was only 13 years old and would go on to patent more than 500 inventions. Among the first and most famous of these were his affordable, synthetic polarised materials developed to reduce glare in camera and sunglass lenses. In 1937, Land and his partner George Wheelwright named their newly-incorporated business after this invention – the Polaroid Corporation. In 1943, whilst on holiday with his family, Land's young daughter asked to see a photo he had just taken of her. Land was immediately intrigued – why wouldn't it be possible to make a photograph instantly available?



Beautifully imperfect

Land developed a new technology that allowed developer chemicals to react with the photo paper inside the camera. In 1948, the first Polaroid instant camera, the Land Camera Model 95, was released. The unpredictable nature of the development process in every version of the Polaroid camera, including the OneStep SX-70, always added its own unique life to a photo. Through the decades, Land collaborated with contemporary artists and photographers like Keith Haring and Andy Warhol, who played a big role in developing The Polaroid Collection – an extensive library of iconic Polaroid photographs.



The Polaroid Company dominated the global instant photography market well into the early 1980s. Towards the turn of the century, however, the company struggled to find its footing in the emerging digital era. In 2008, following two bankruptcies, new owners saw the potential in their original founder's values of inspiring change, documenting real life and expressing creative ideas through a tangible medium. They launched The Impossible Project to revive and redefine the future of instant film photography. The initiative, and the newly reconstructed Polaroid B.V., fed right into a desire among new artists, enthusiasts and professionals to experiment with authentic, real-life photography. Now, more than 85 years after his company was founded, Edwin Land's legacy lives on in new camera technology that has been embraced by a flourishing global community of fans and creators.

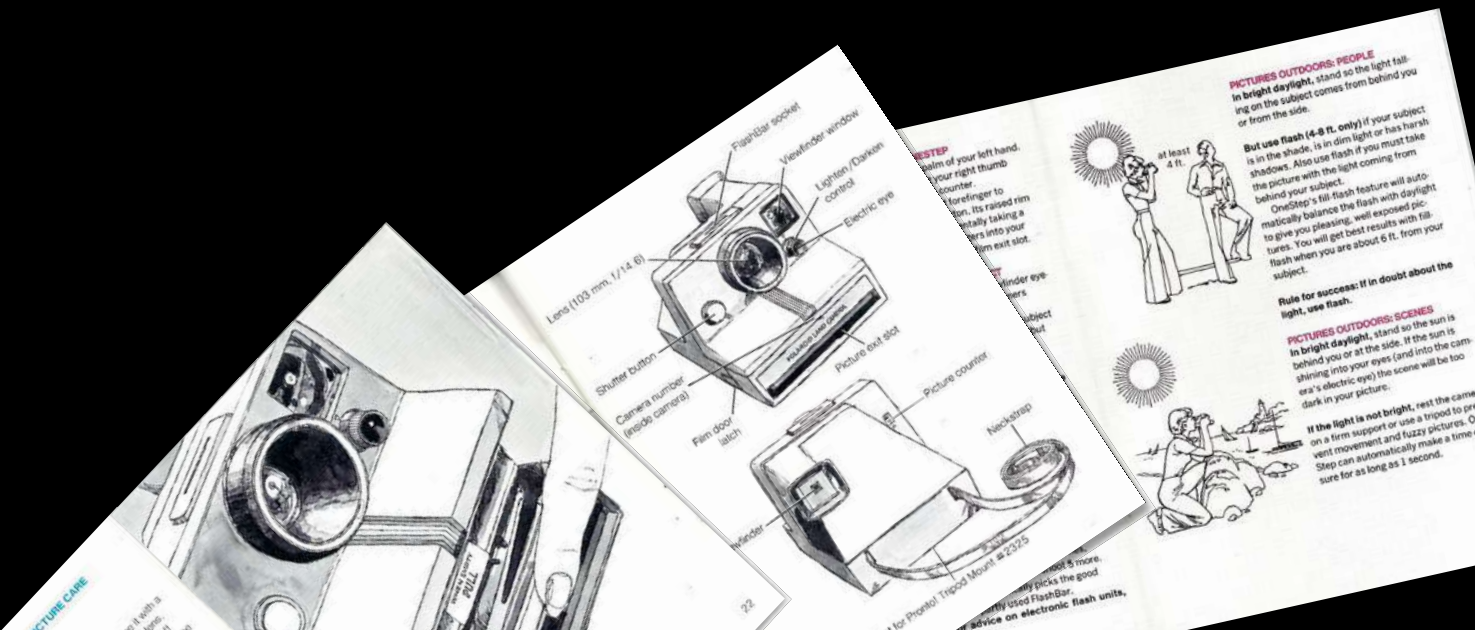

From the LEGO® Design Team

“The Polaroid OneStep SX-70 from 1978 is a classic 20th-century design icon. Marc’s submission made us do a double-take of ‘Wait, that’s made of LEGO® bricks?’ and we wanted to keep that accuracy in the final model. Being able to ‘take’ a photo with the press of a button is definitely the most satisfying part. We originally planned to use two stickers for the stripe on the front of the camera, but we worked out some creative building angles to allow the iconic stripes to flow down the front and over the side using LEGO plates. Having a functional viewfinder really adds to the play value of the model. And yes, it may be a model for adults, but I hope you’ll still have fun *playing* with it!”

James May, LEGO® Ideas Model Designer





LEGO® Ideas designers James May
and Matthew Parsons

“One of the challenging parts for me as a Graphic Designer was deciding where to use printed parts or stickers so the model would maintain its iconic look. Photography is a magical way to capture special moments you can share with others or treasure for yourself, and I hope the photo eject function is something that will spark joy in Polaroid fans! The PP foil used in the ‘photographs’ really helped us perfect the look and feel of the original. Inspired by the theme ‘Memories’, we created images that connect the Polaroid legacy with Marc’s family memories and our LEGO® history. PS: In Europe, the camera was launched as Polaroid 1000, so you can choose between the ‘OneStep’ or ‘1000’ stickers for your model.”

Matthew Parsons, LEGO® Ideas Graphic Designer

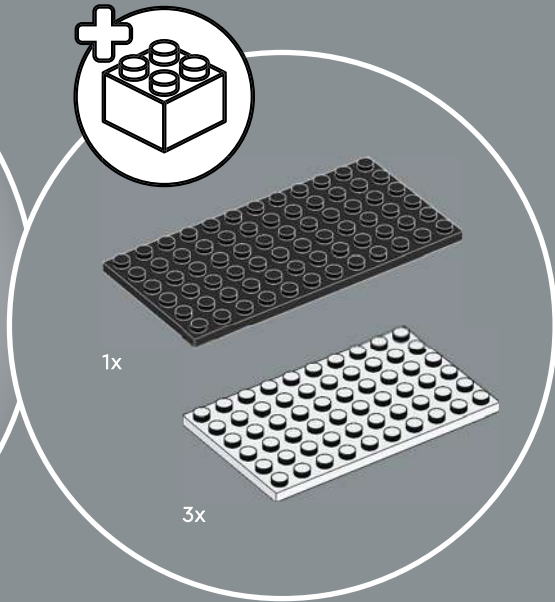

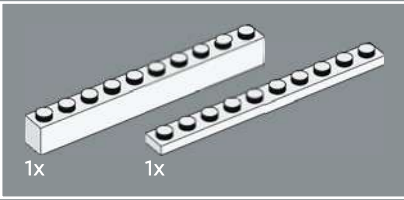
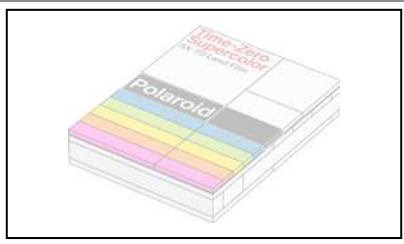

1

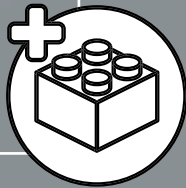
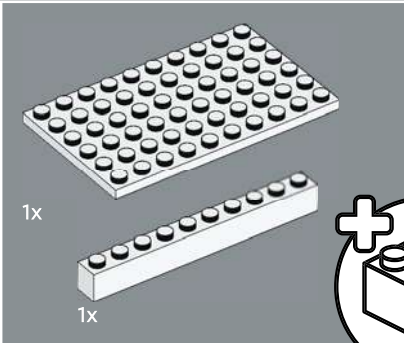
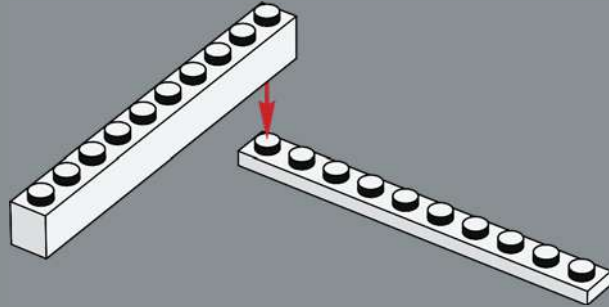

2

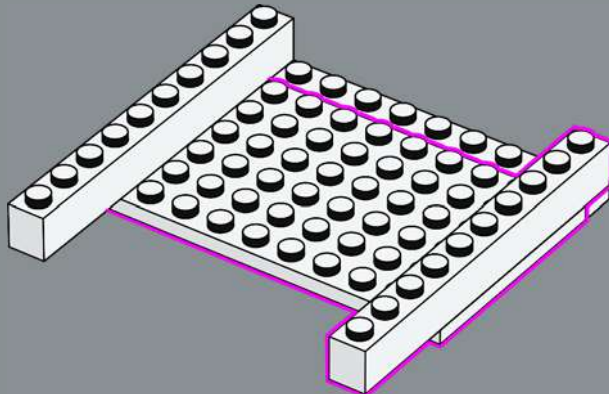

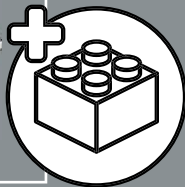
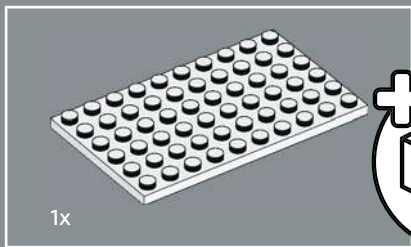

3

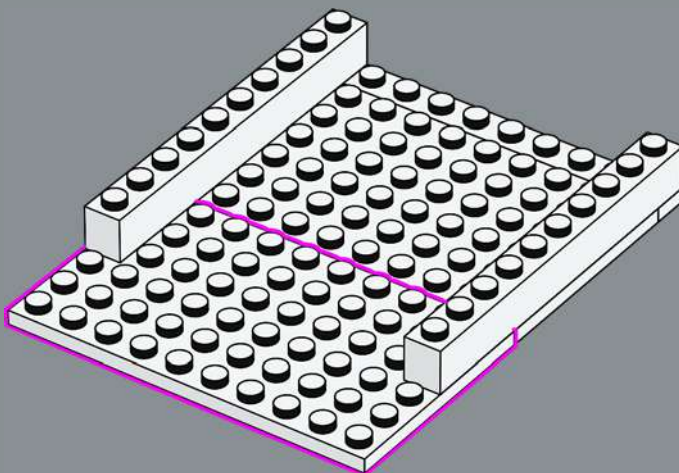

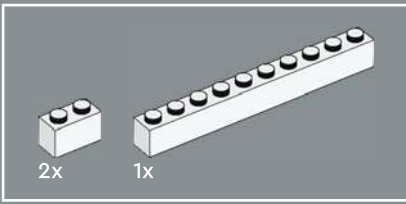

4

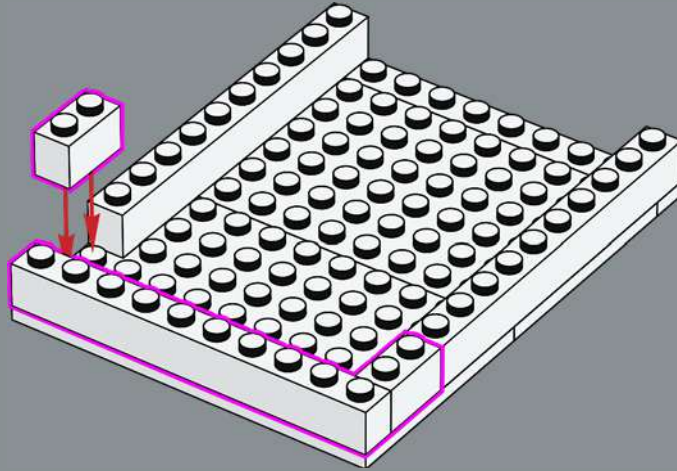

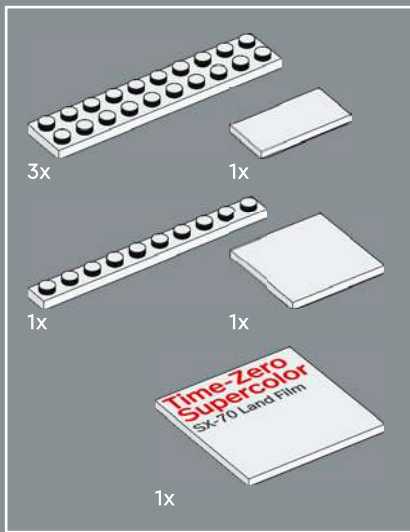

5

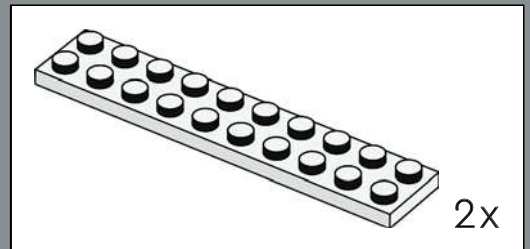
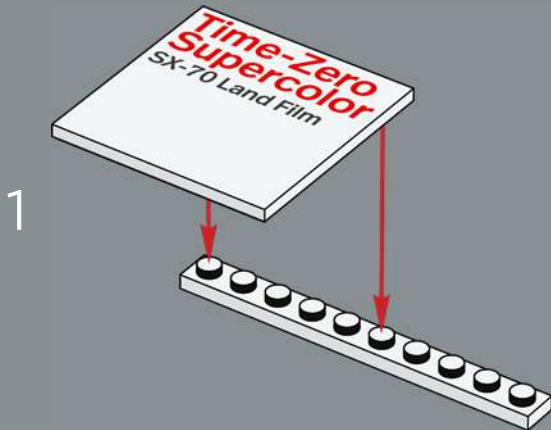

2

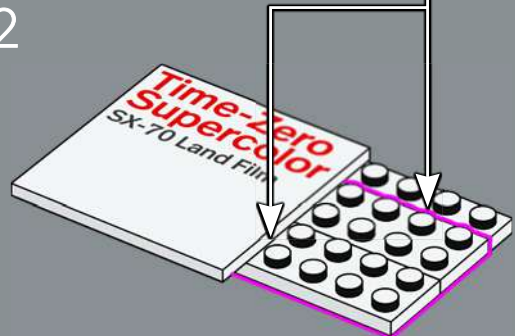

3



4

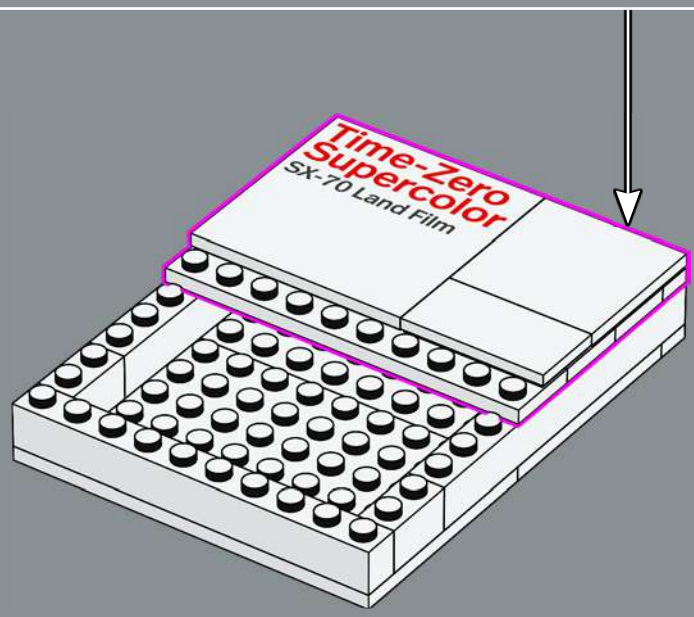
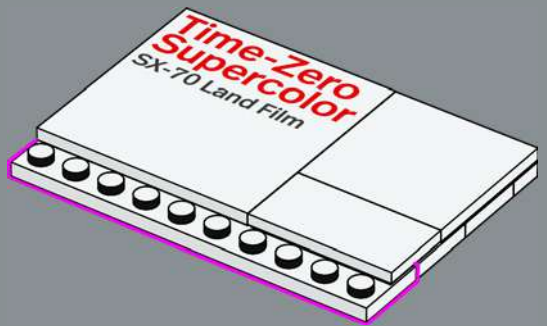

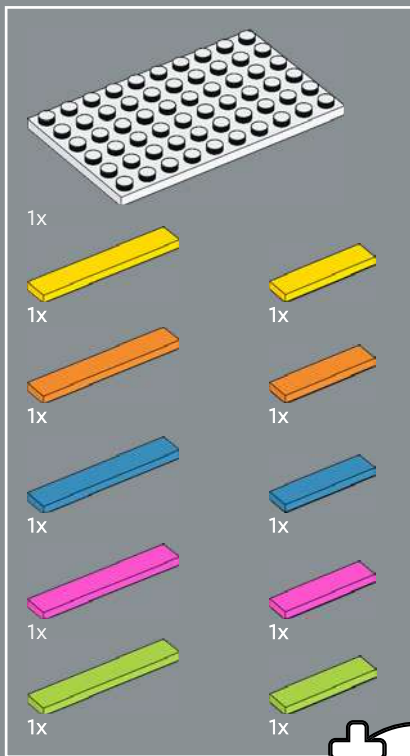

6

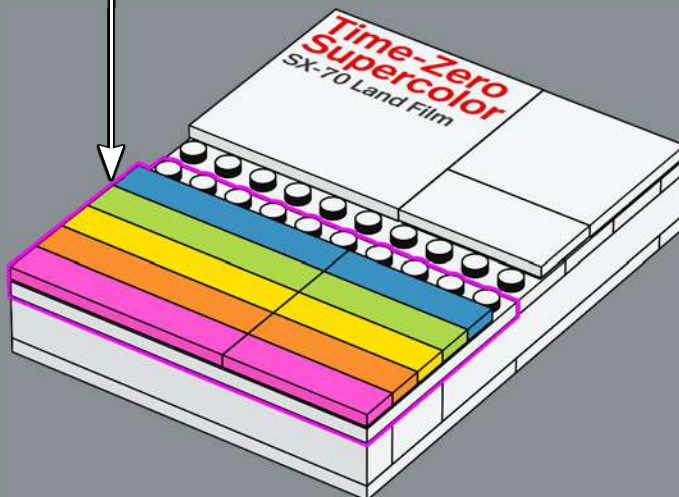
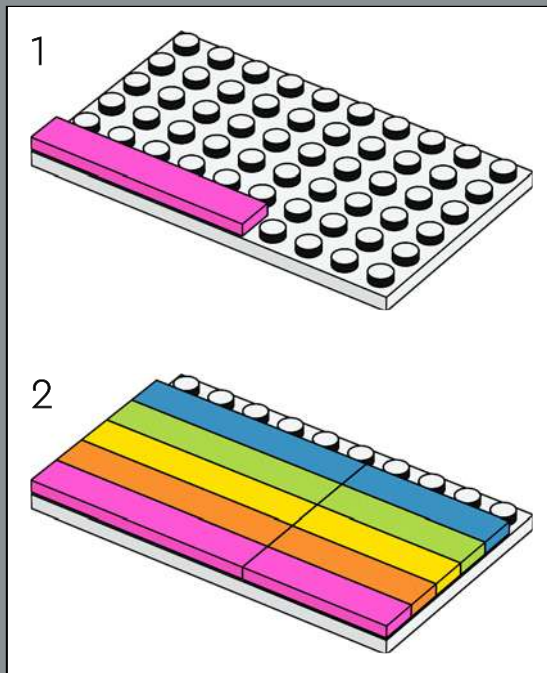
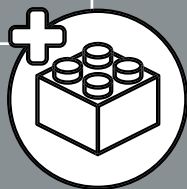

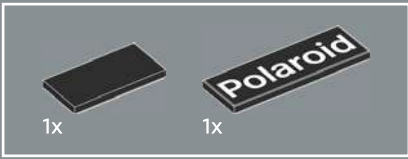

7

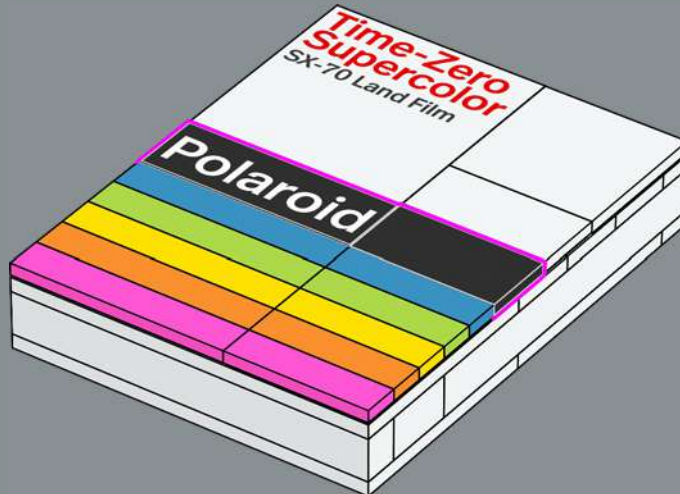

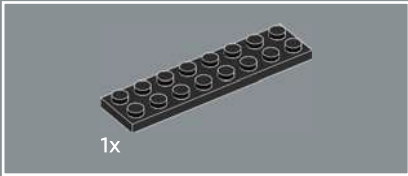
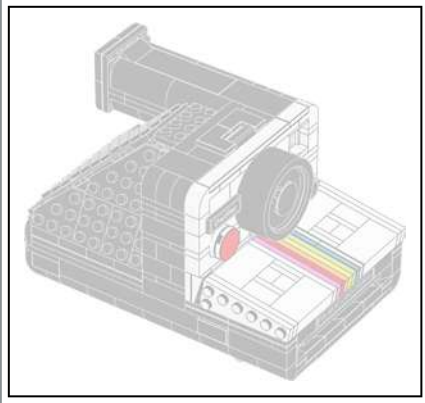

8

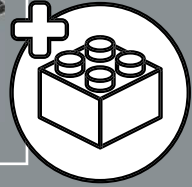
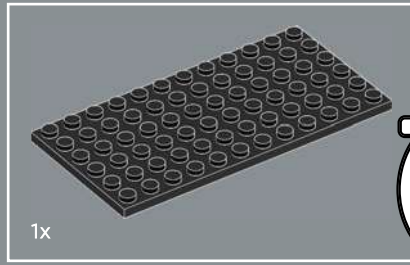
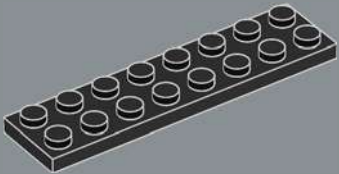

9

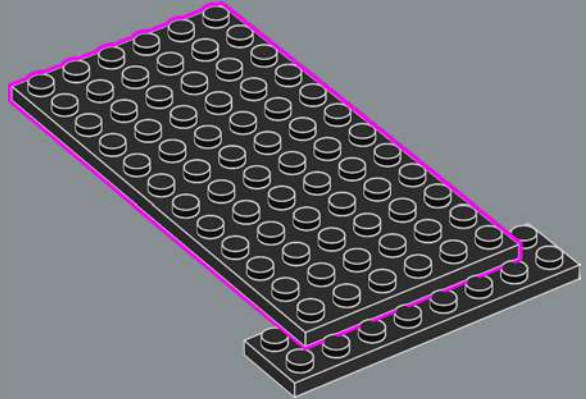

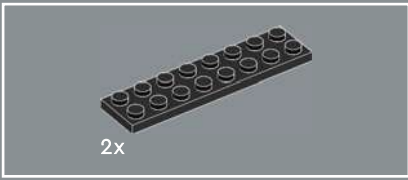

10

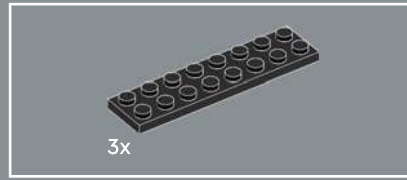
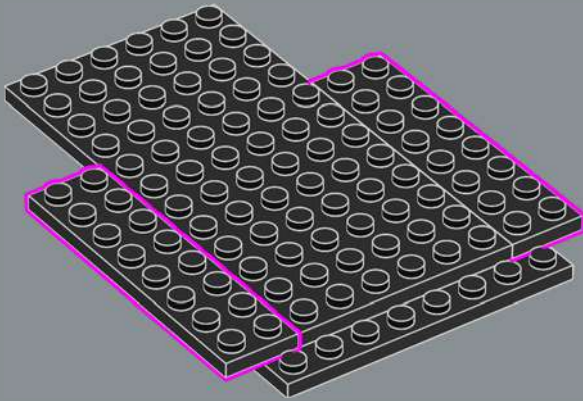

11

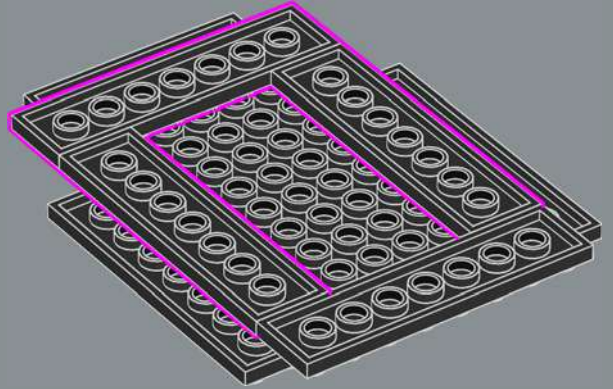

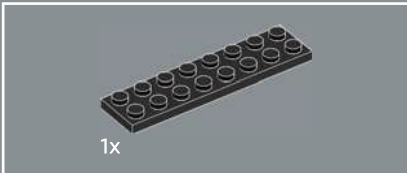
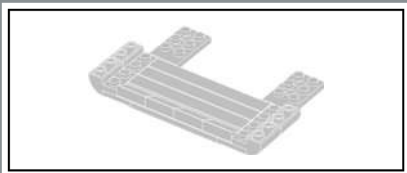

12

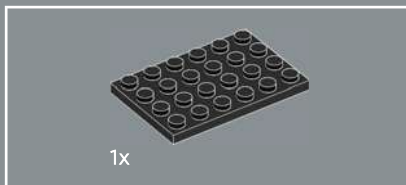
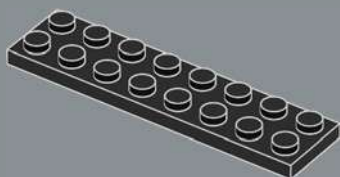

13

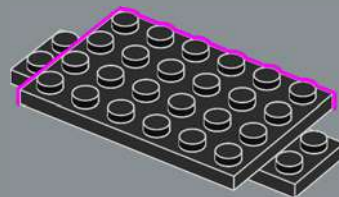



14

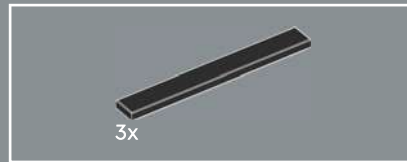
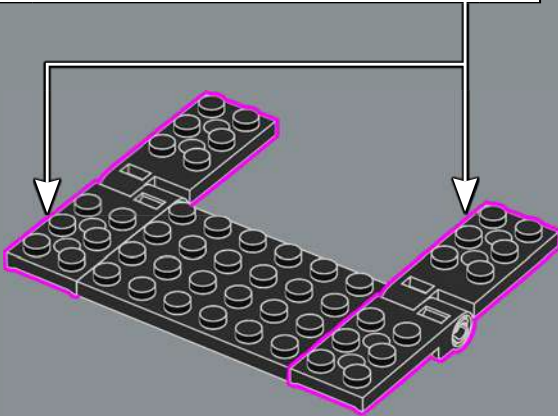
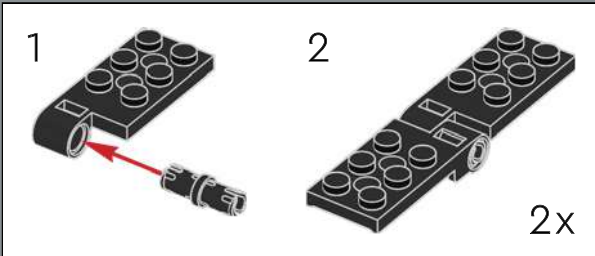

15

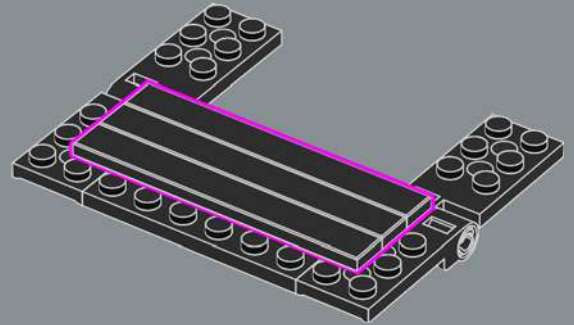

16

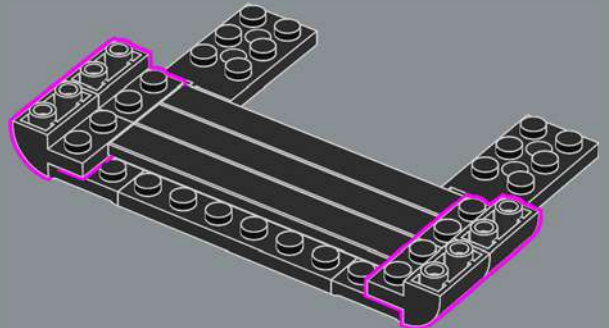



17

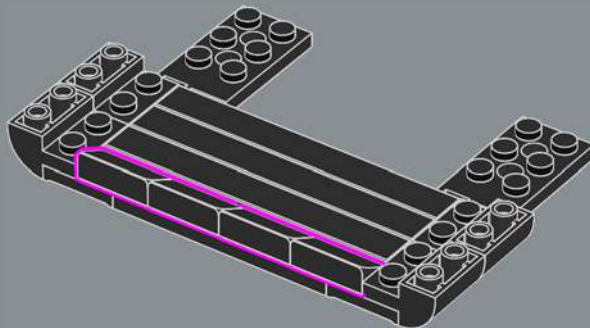

18

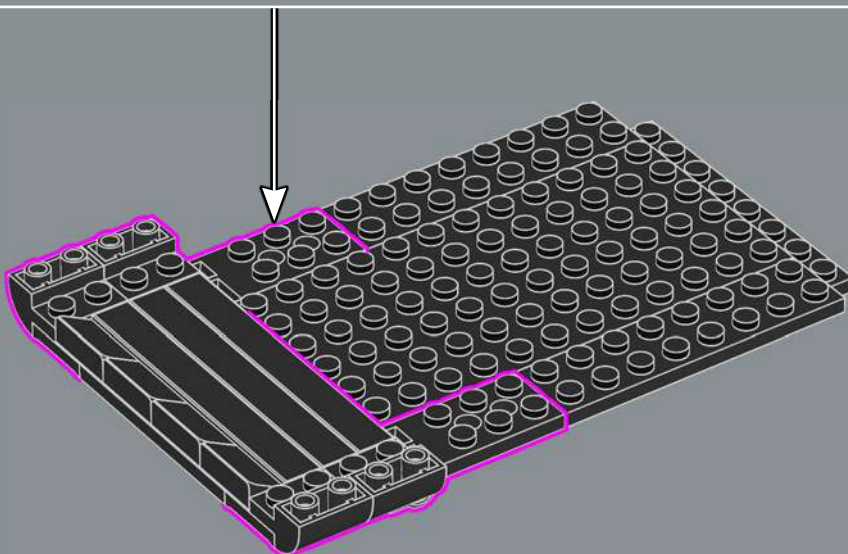

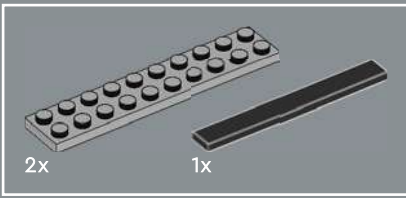

19

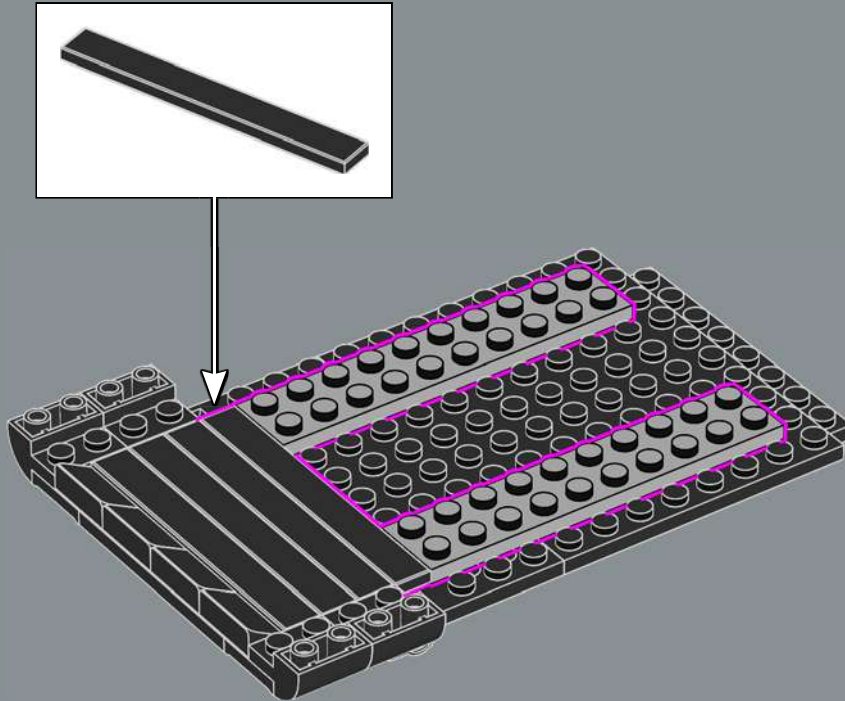

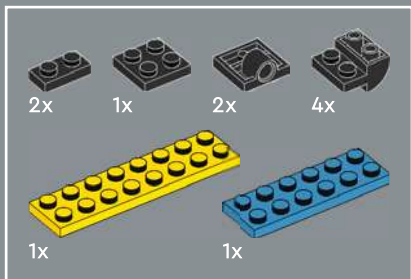

20

1

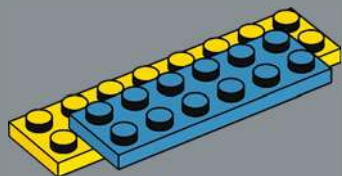

2

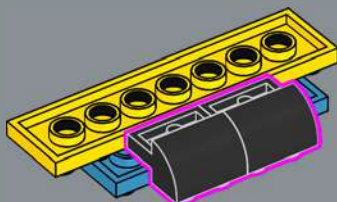

3

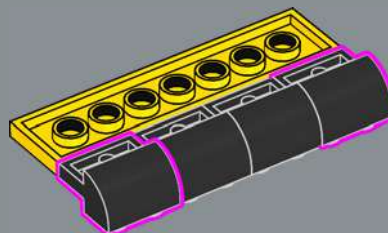

4

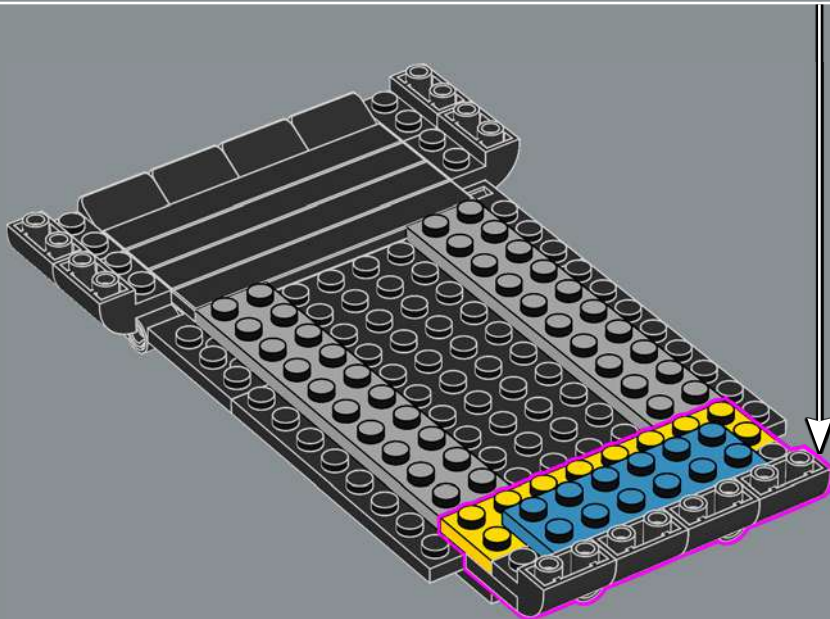
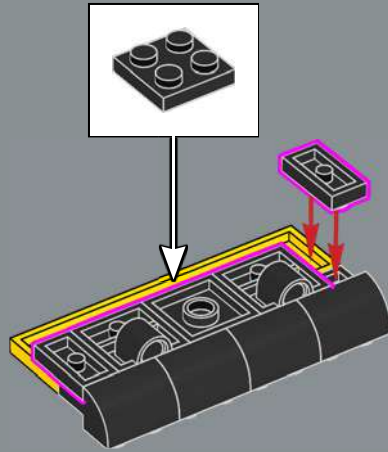



12x

21

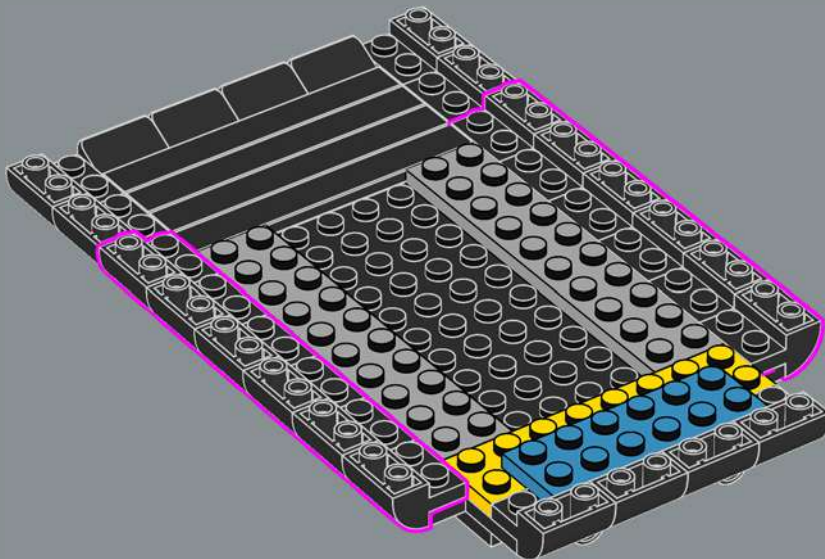

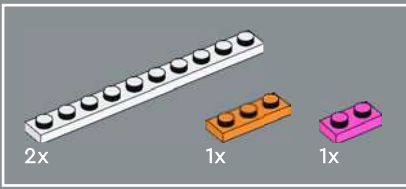

22

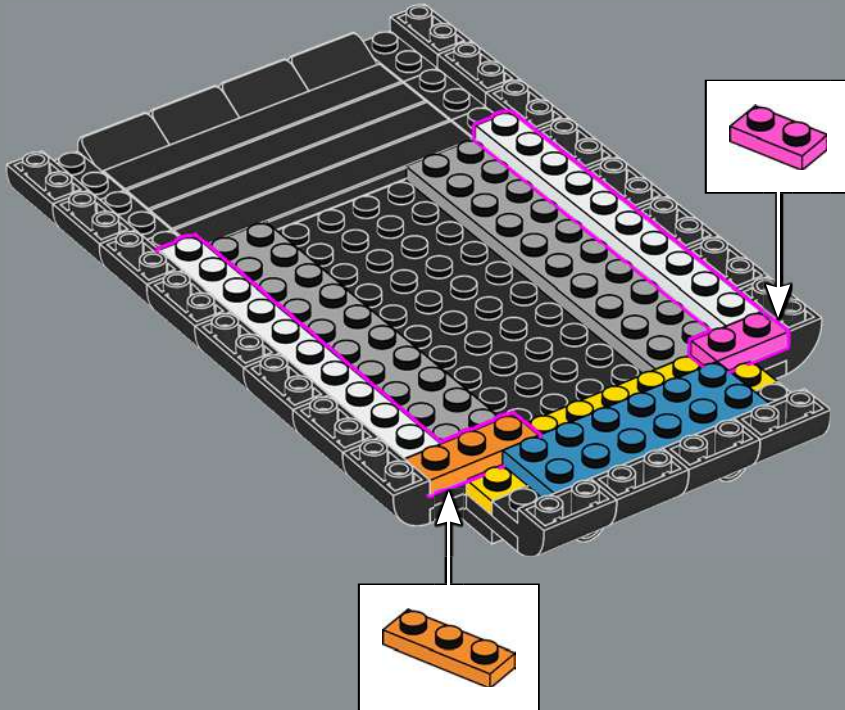

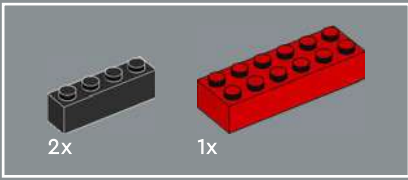

23

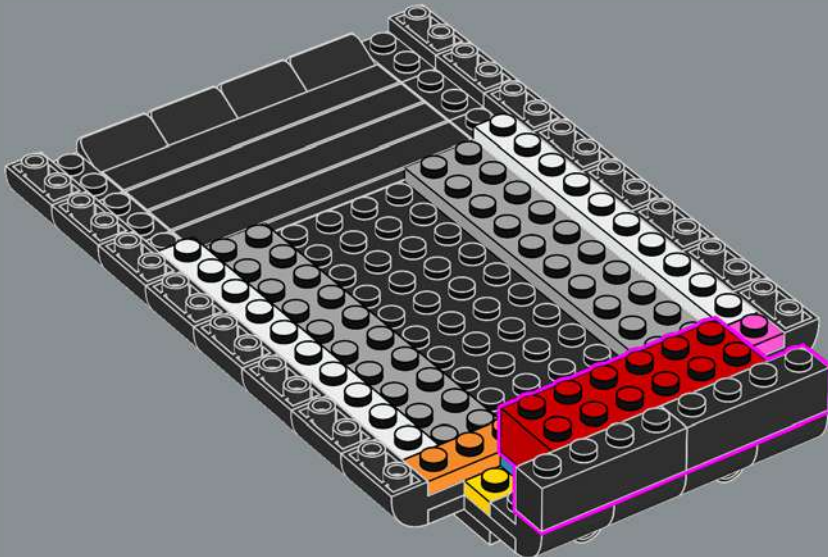

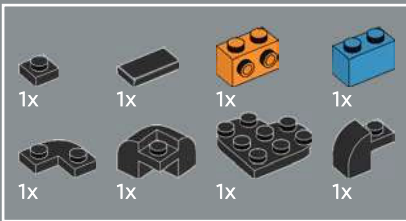

24

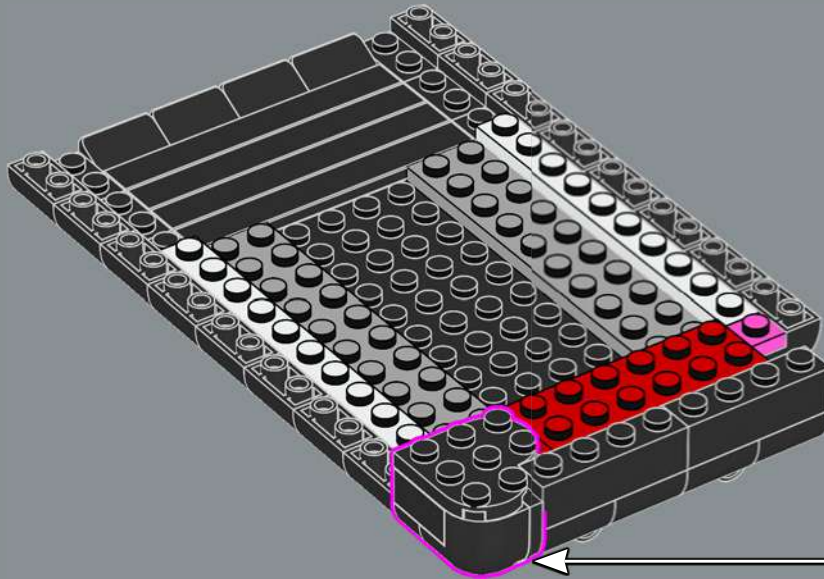
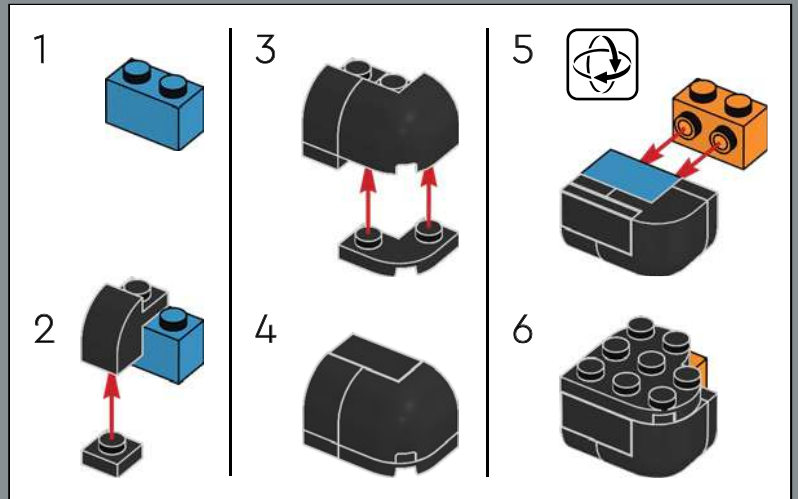

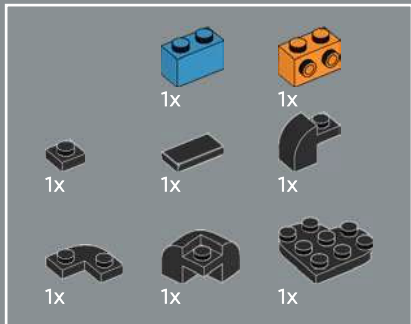

25

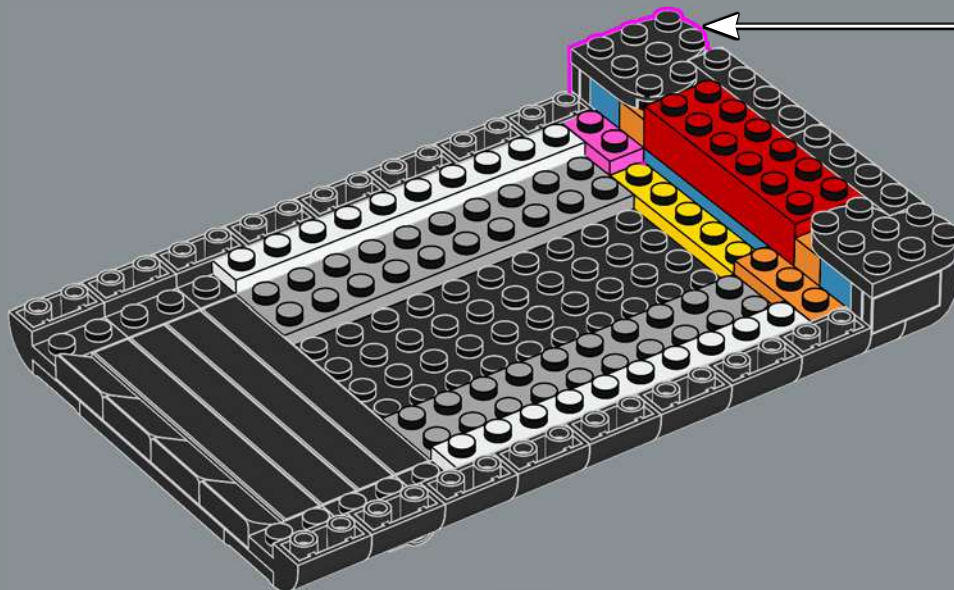
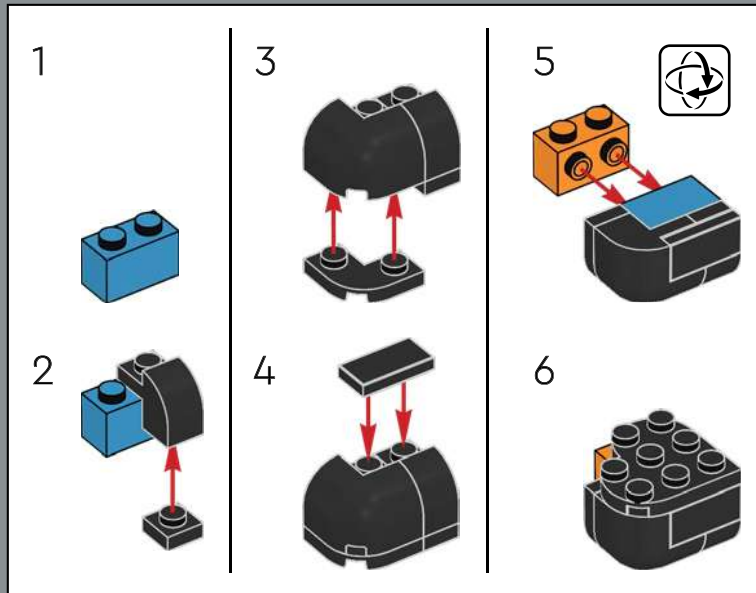

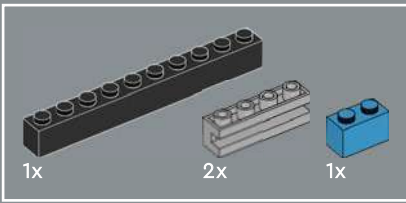

26

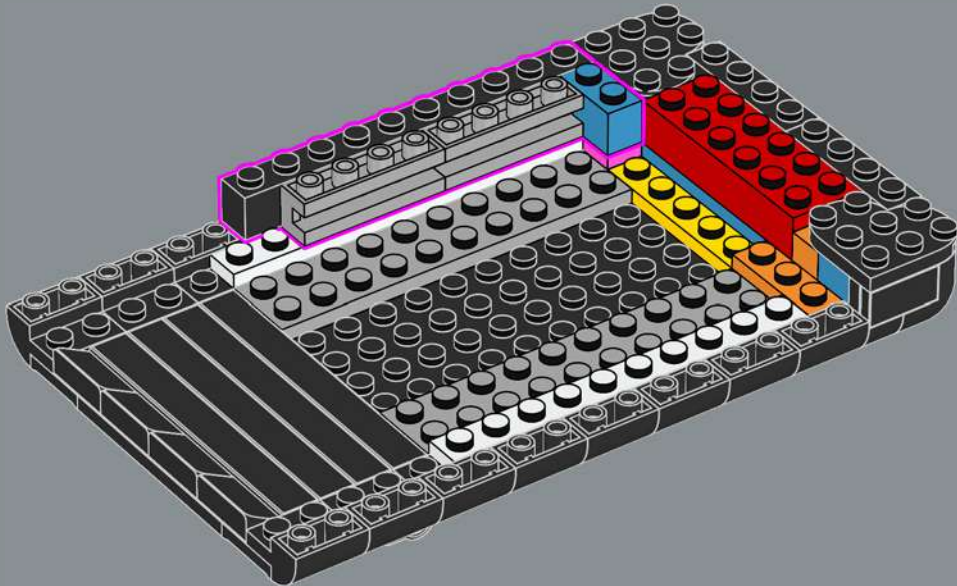

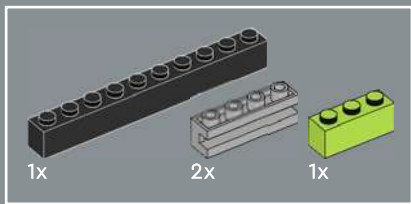

27

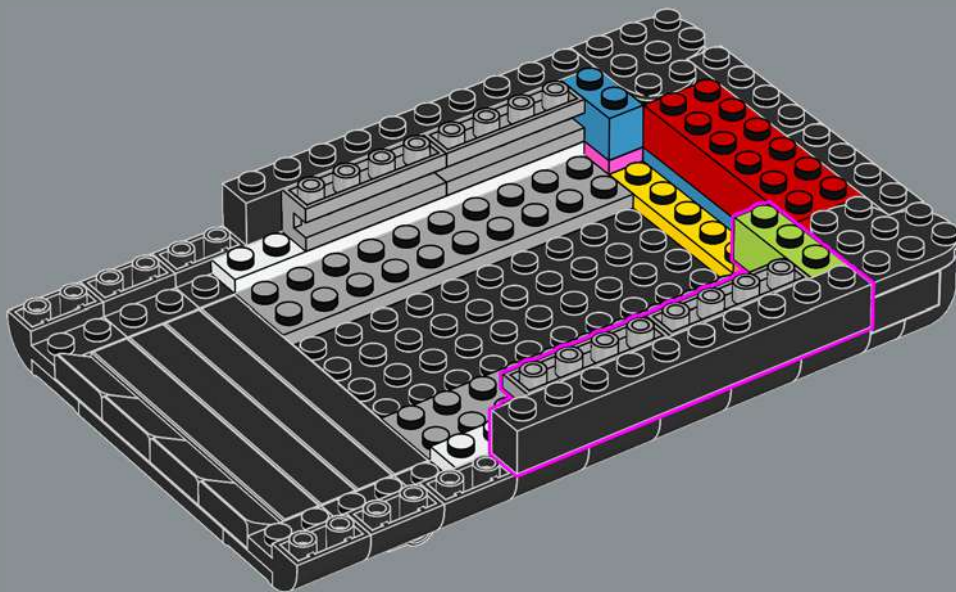

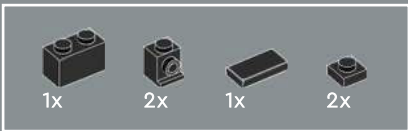

28

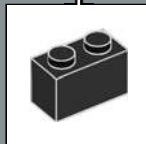
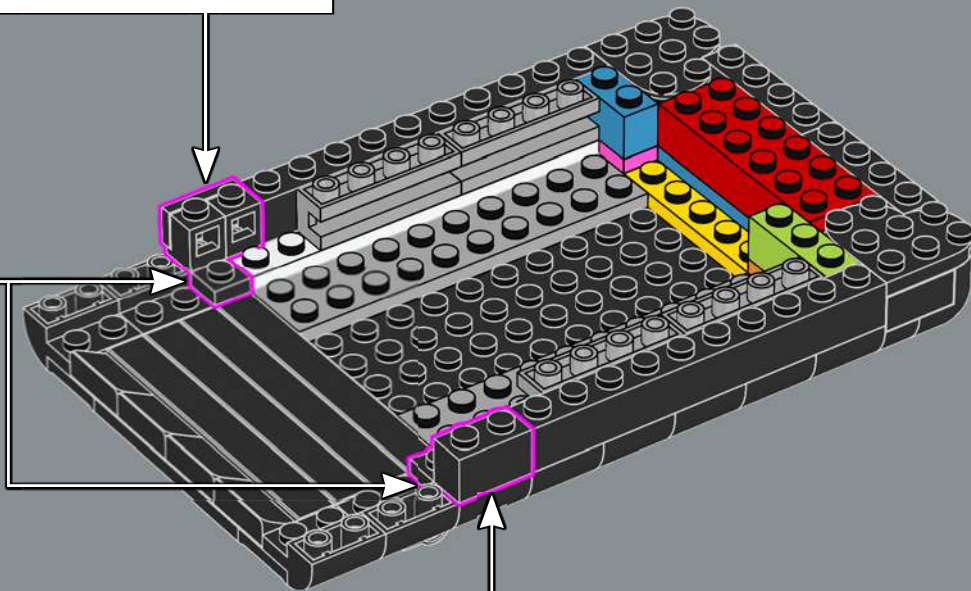
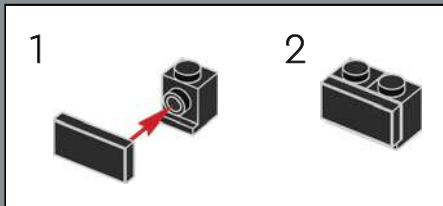

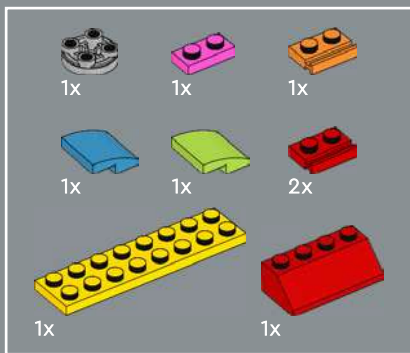

29

1

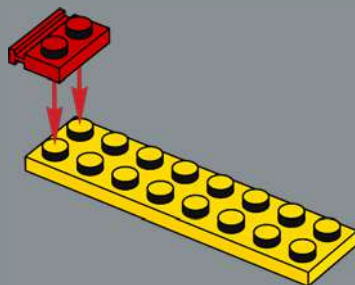

2

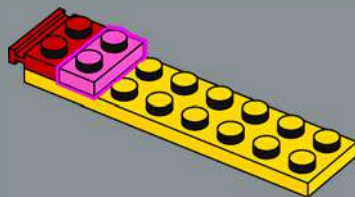

3

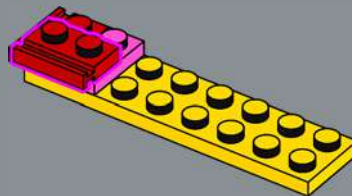

4

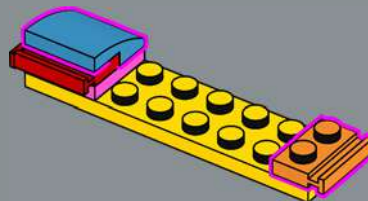

5

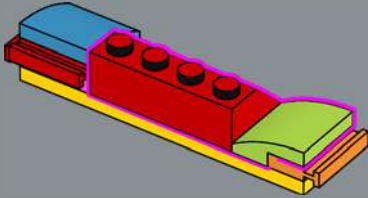

6

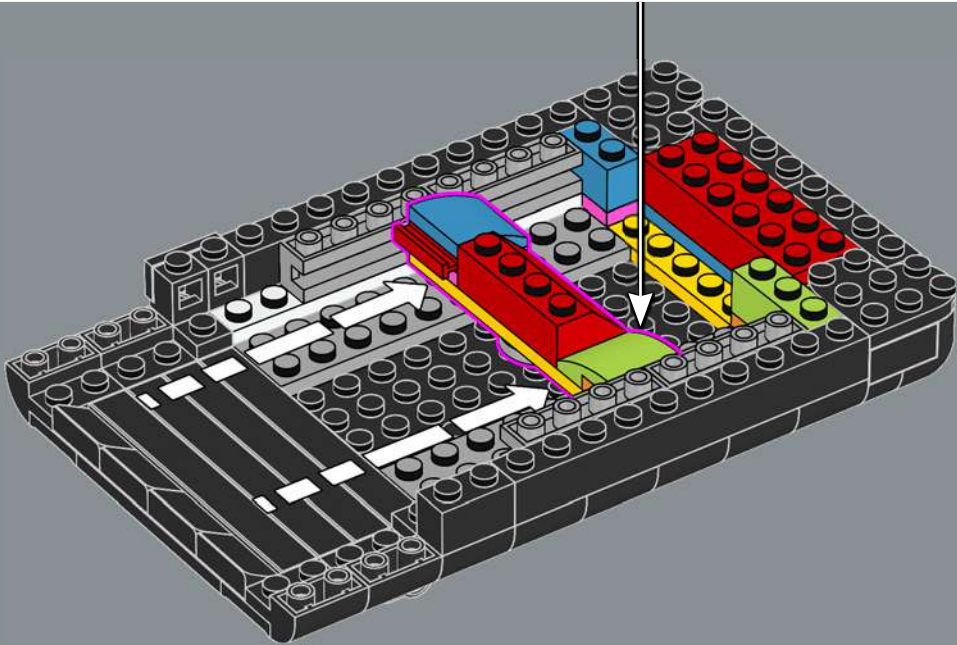
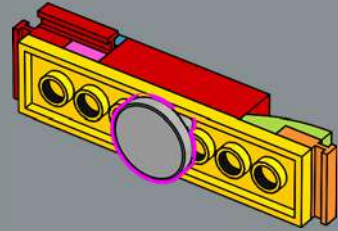



30

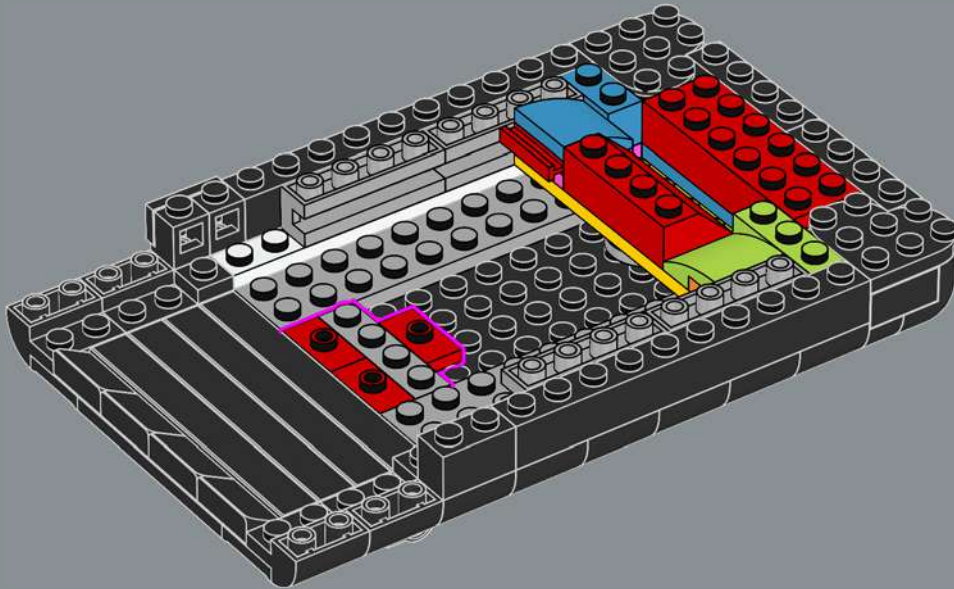

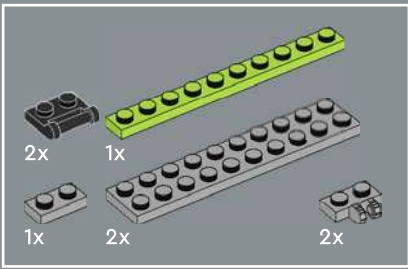

31

1

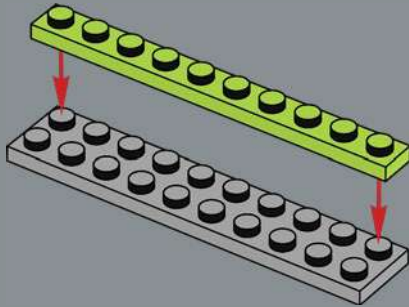

2

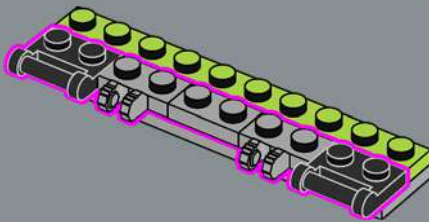

3

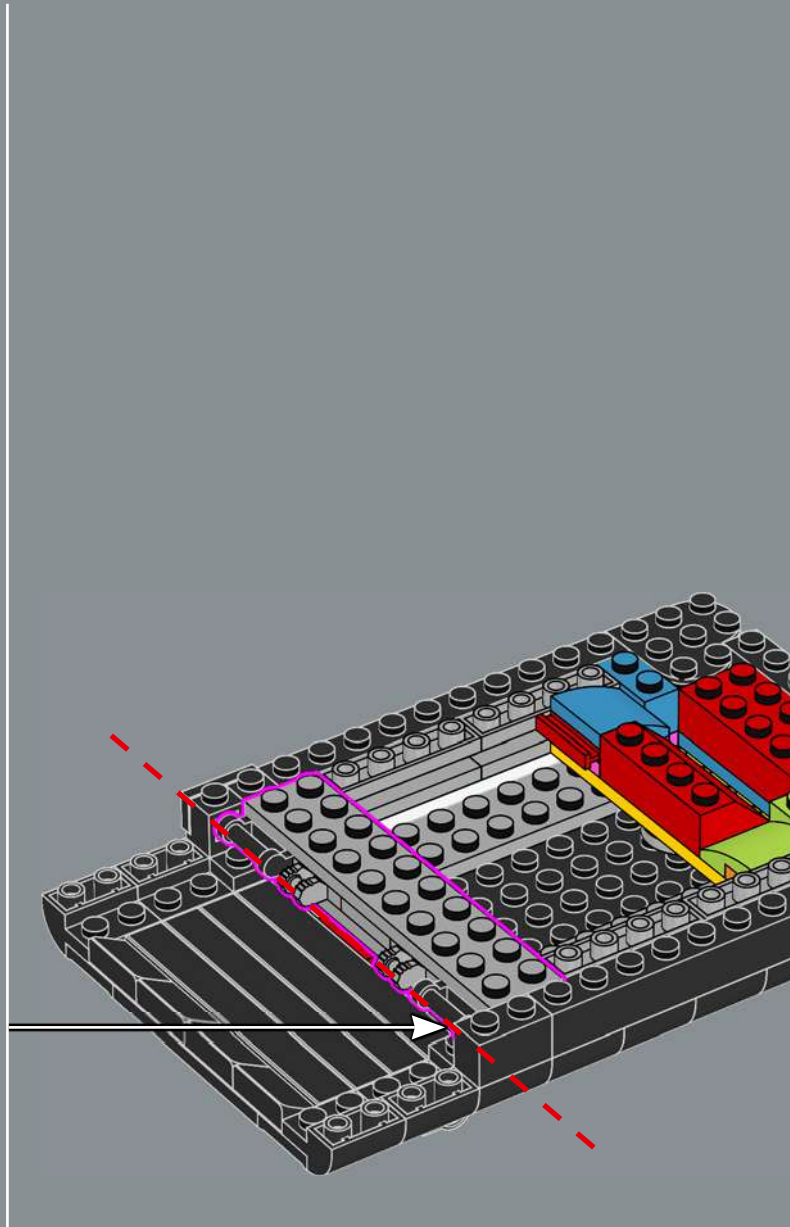
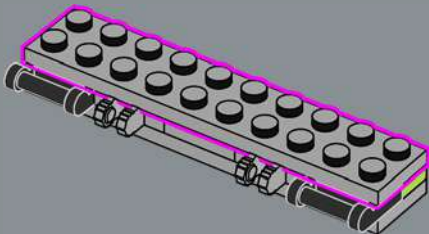

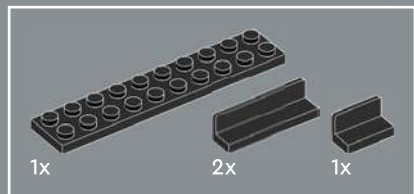

32

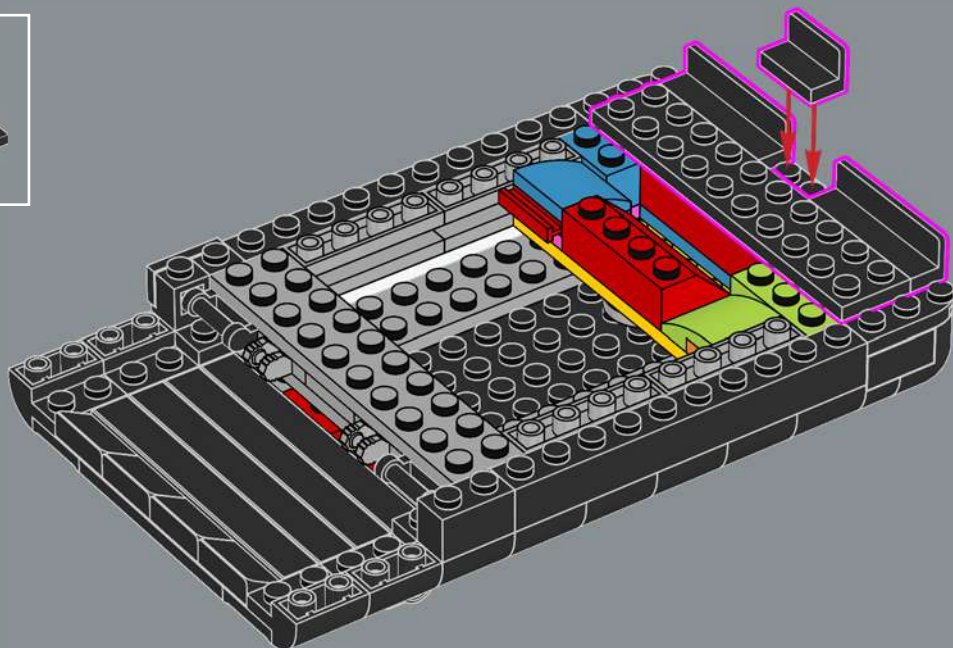

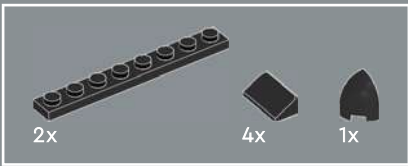

33

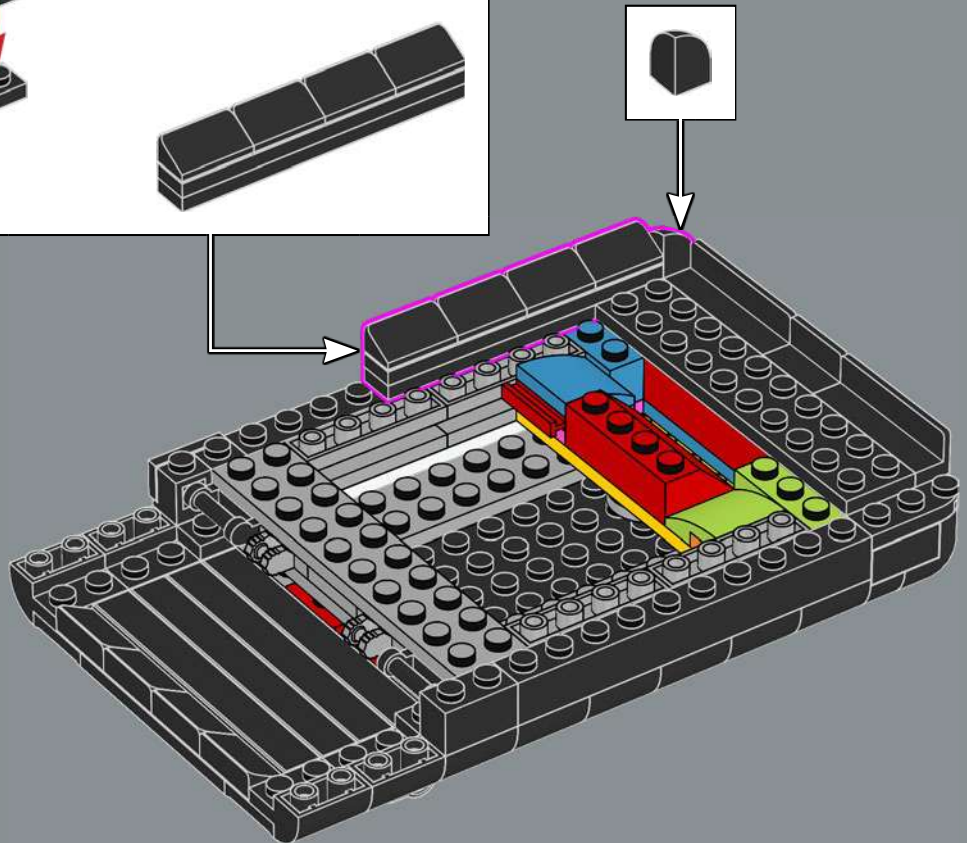
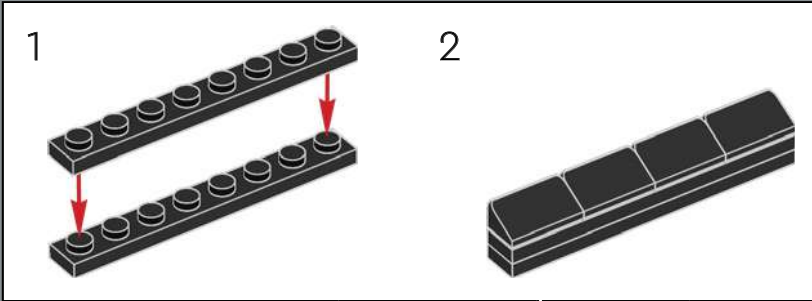

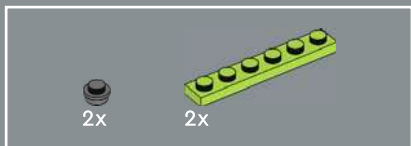

34

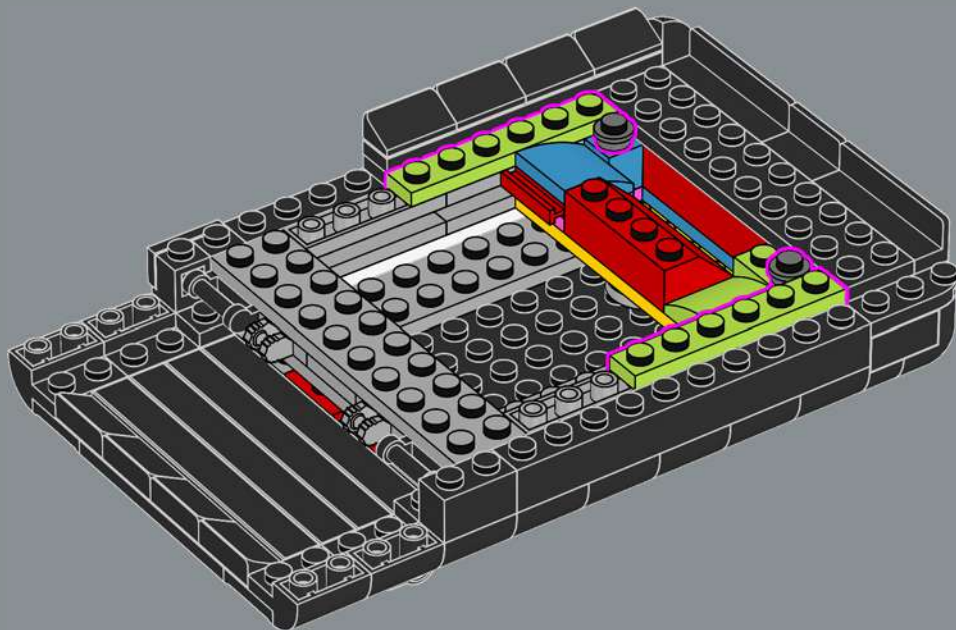

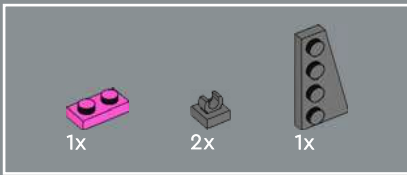

35

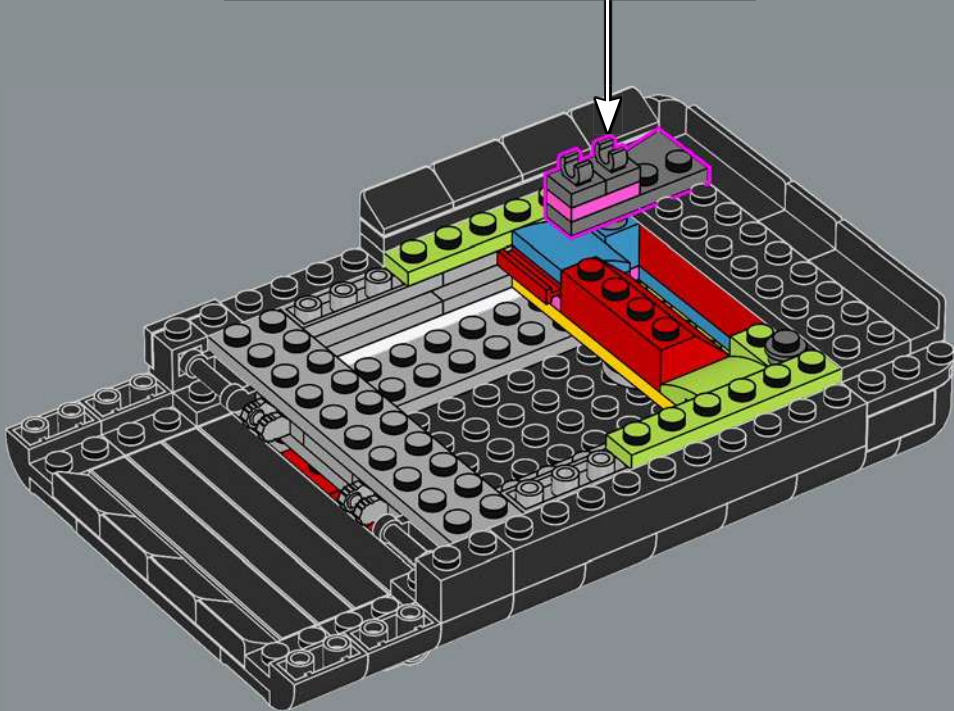
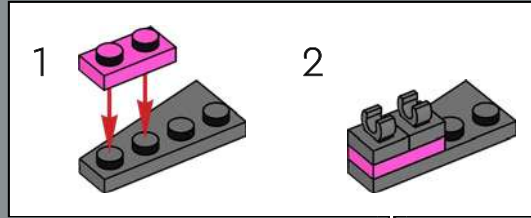



6x

36

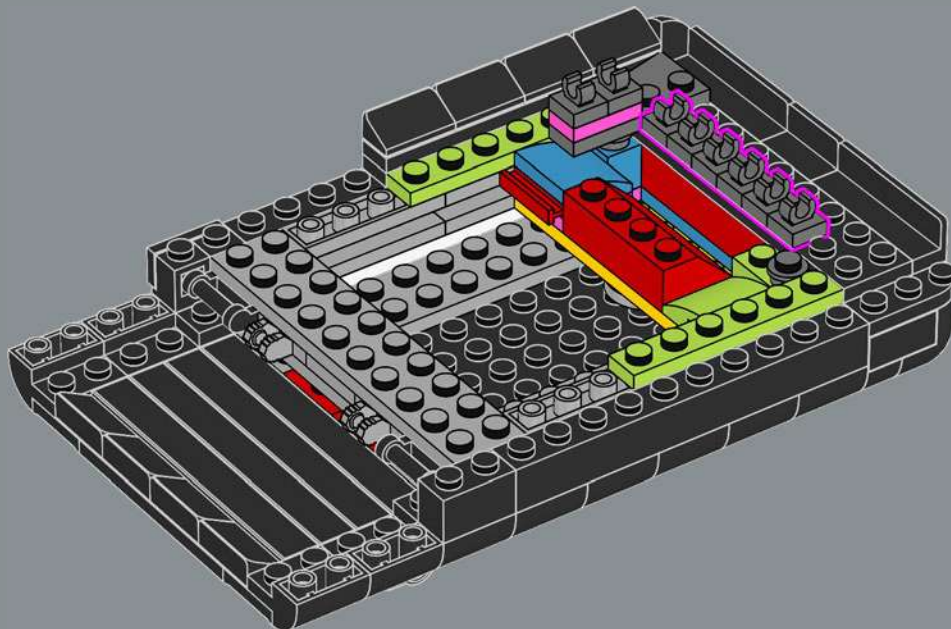

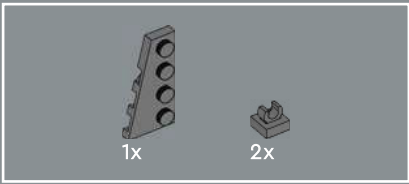

37

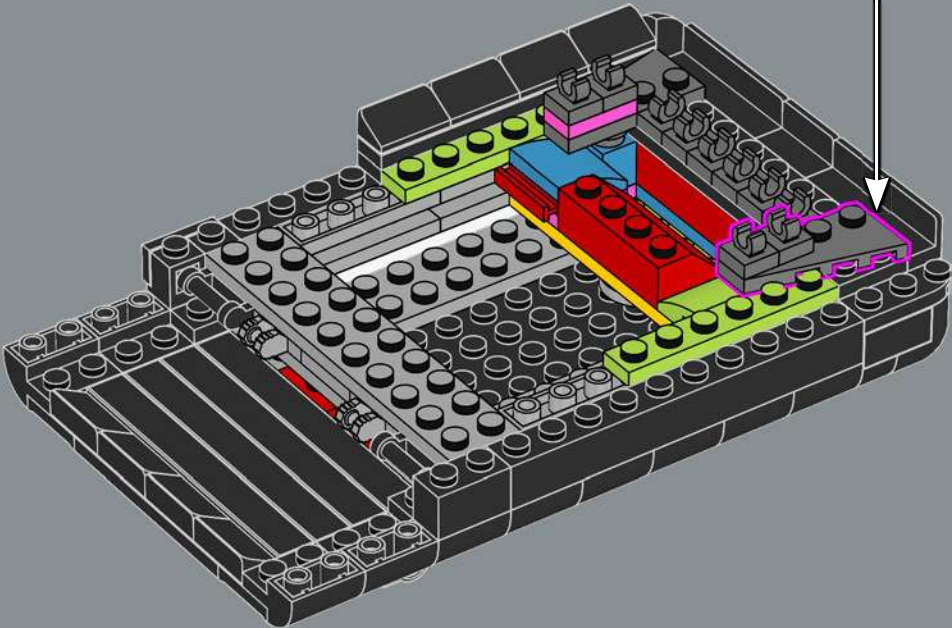
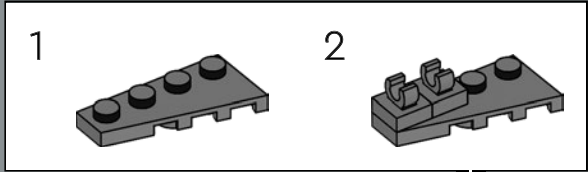

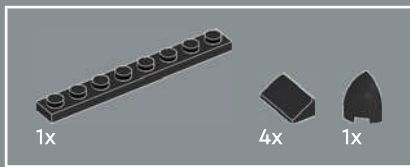

38

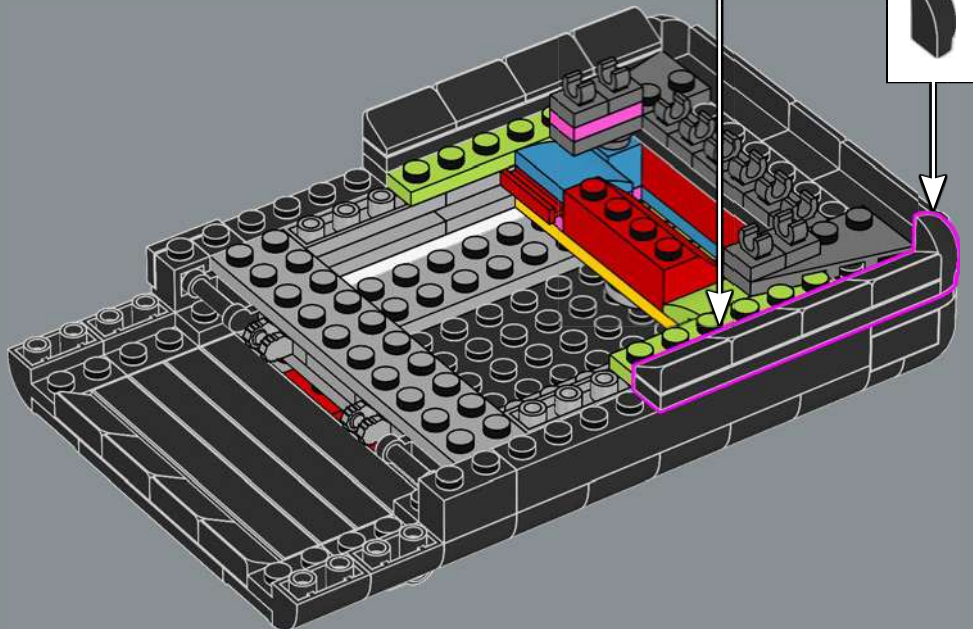
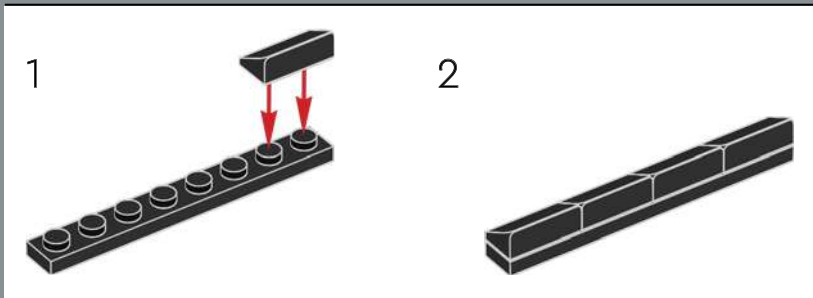

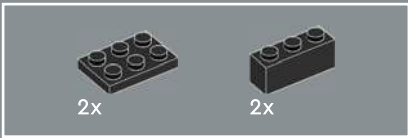

39

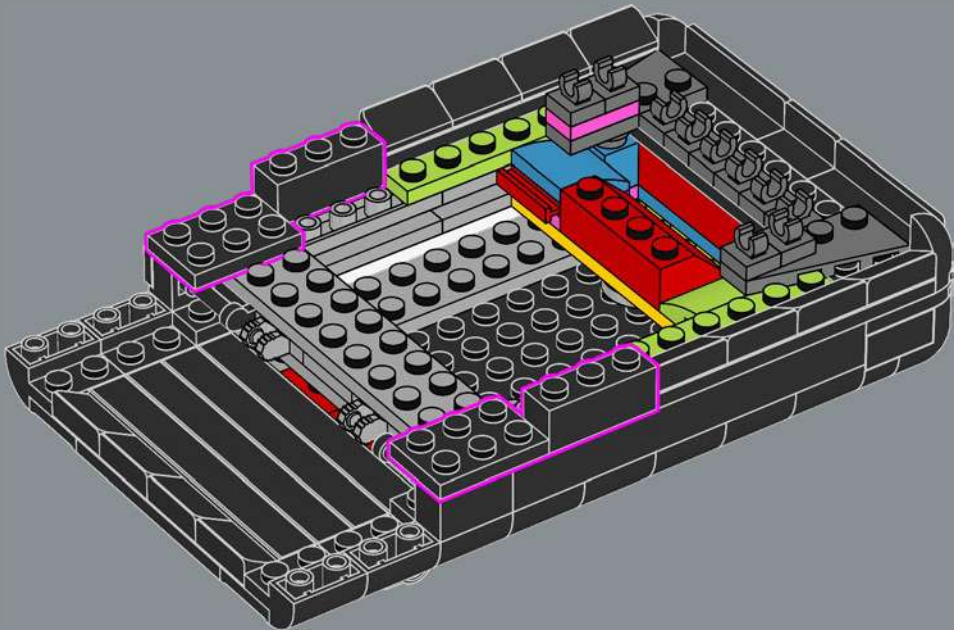



40

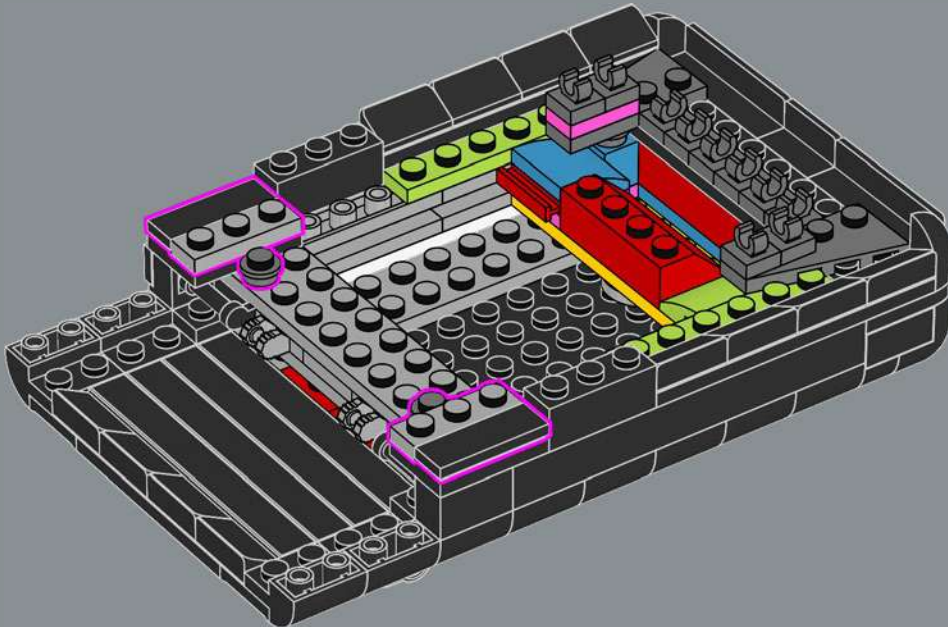

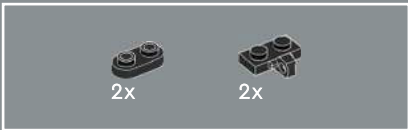

41

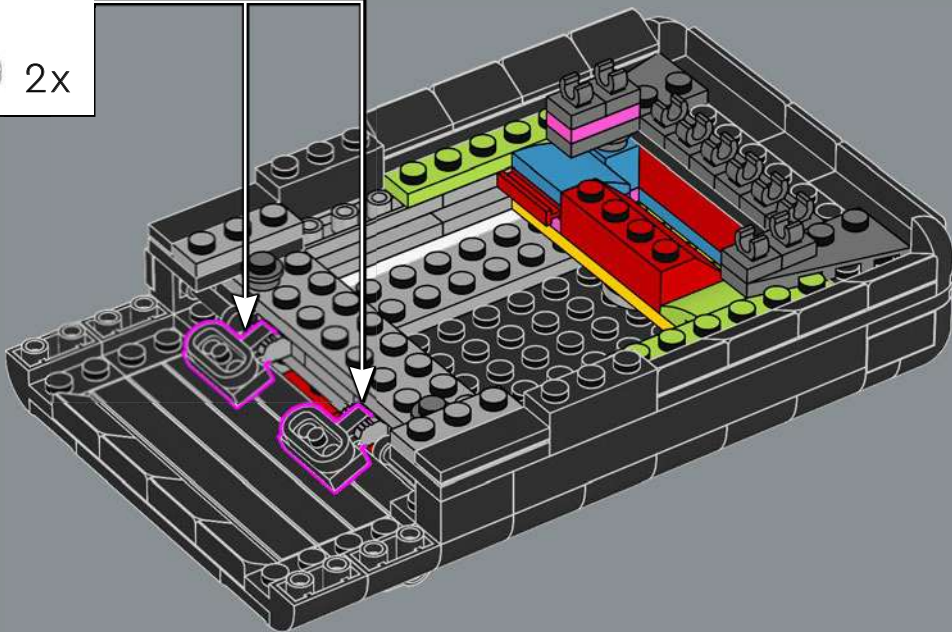
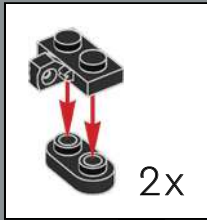

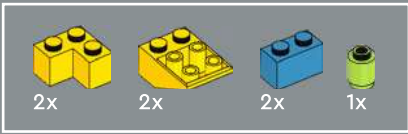

42

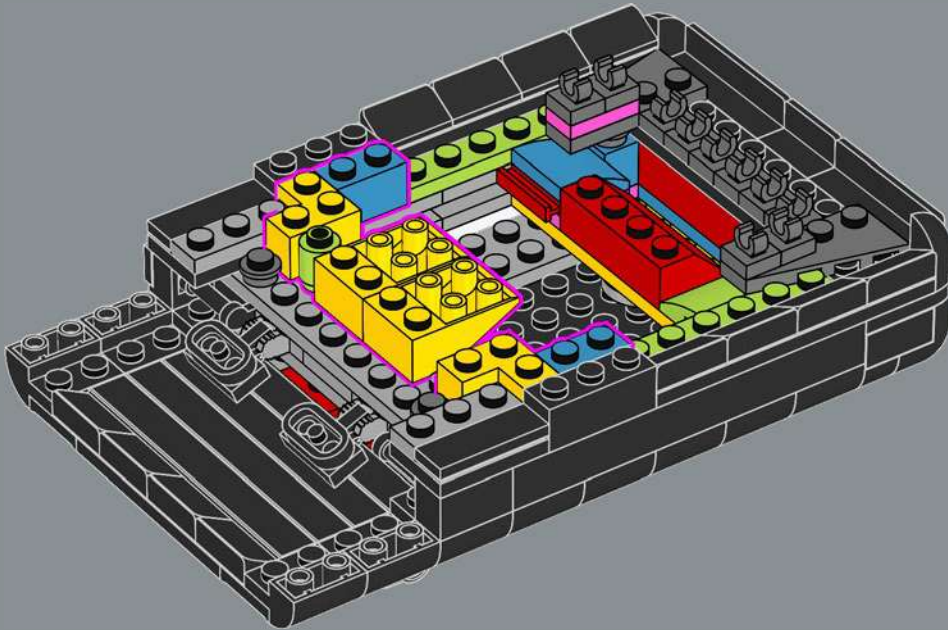

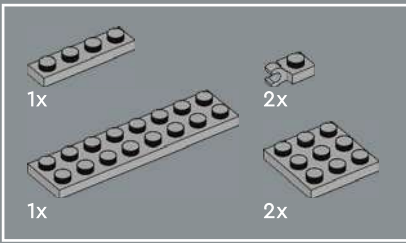

43

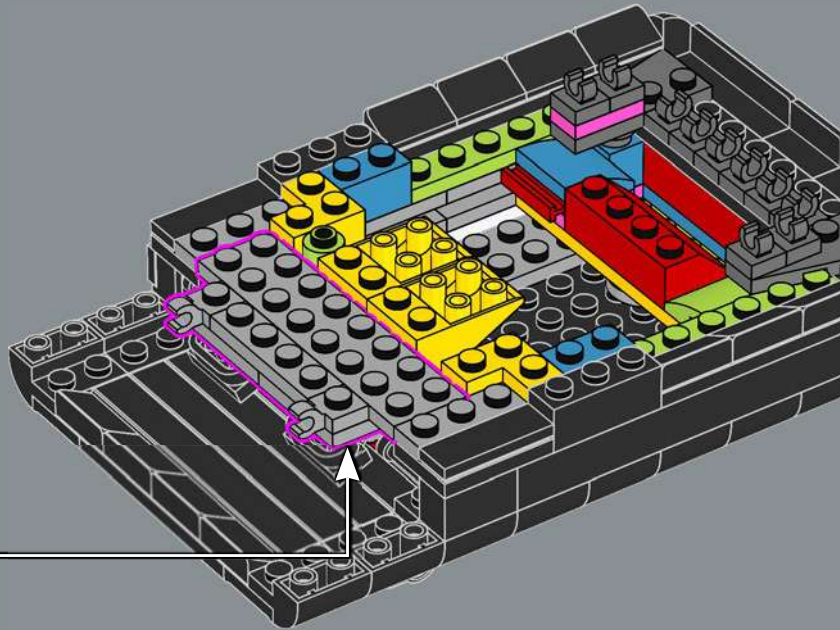
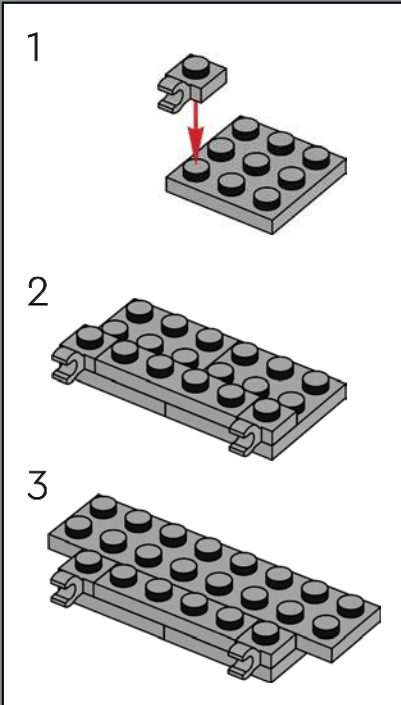

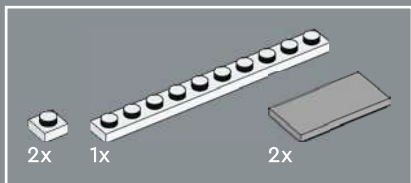

44

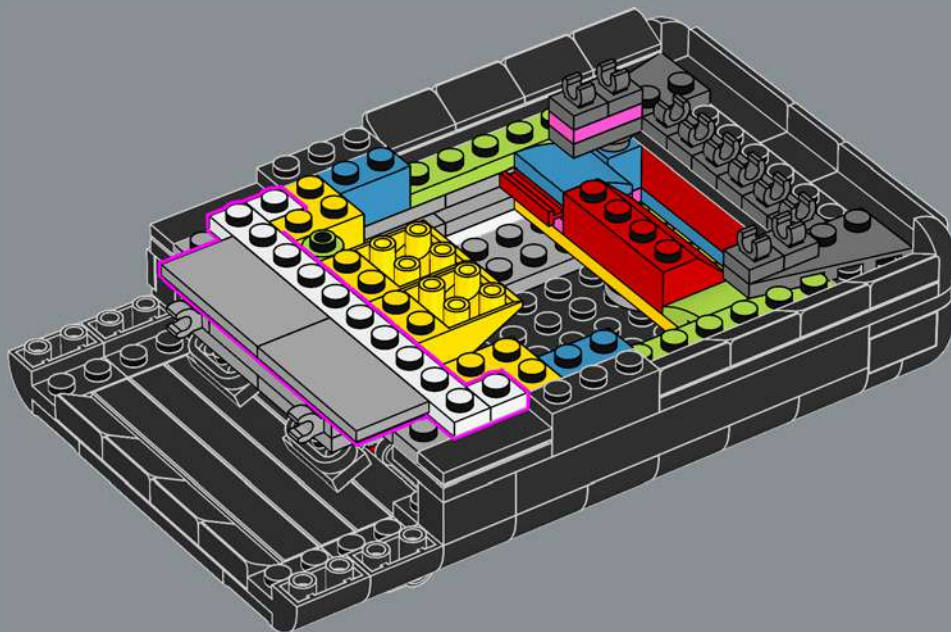

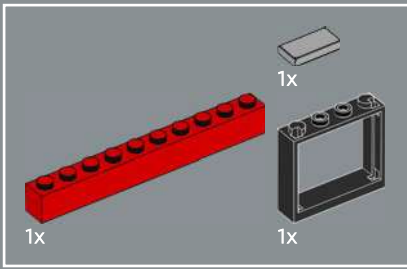

45

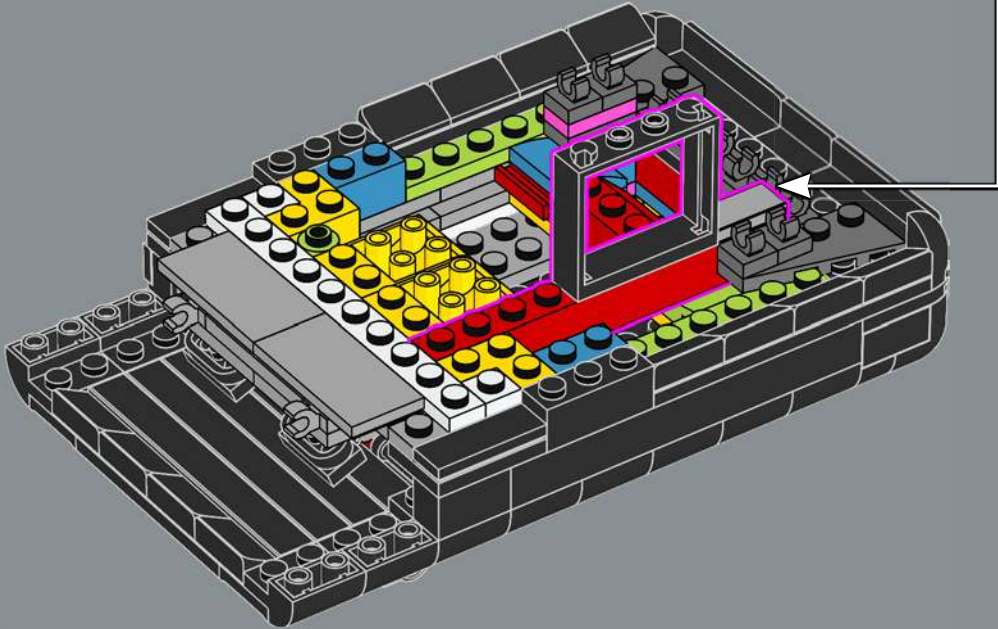
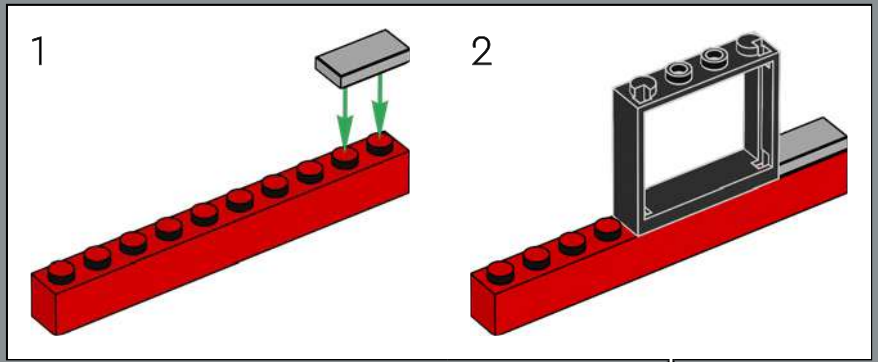

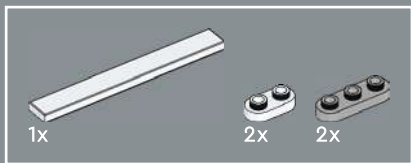

46

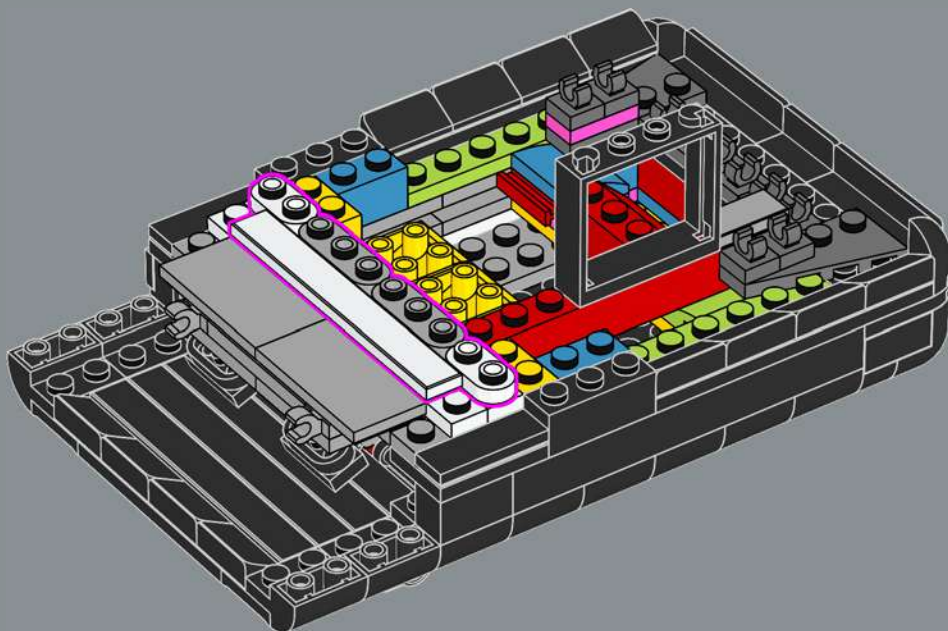

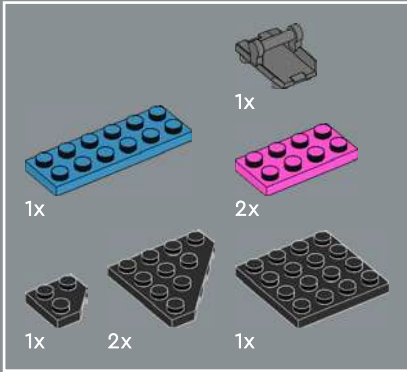
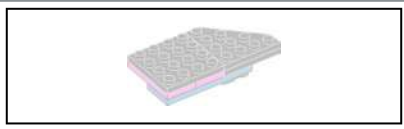

47

1

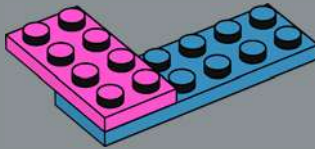

2

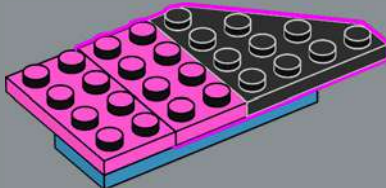

3

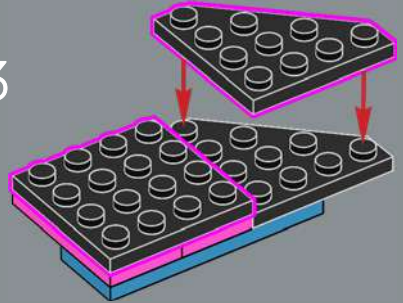

4

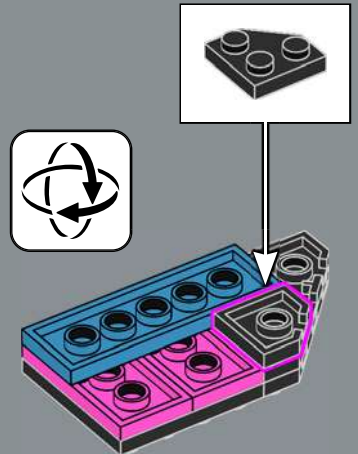

5

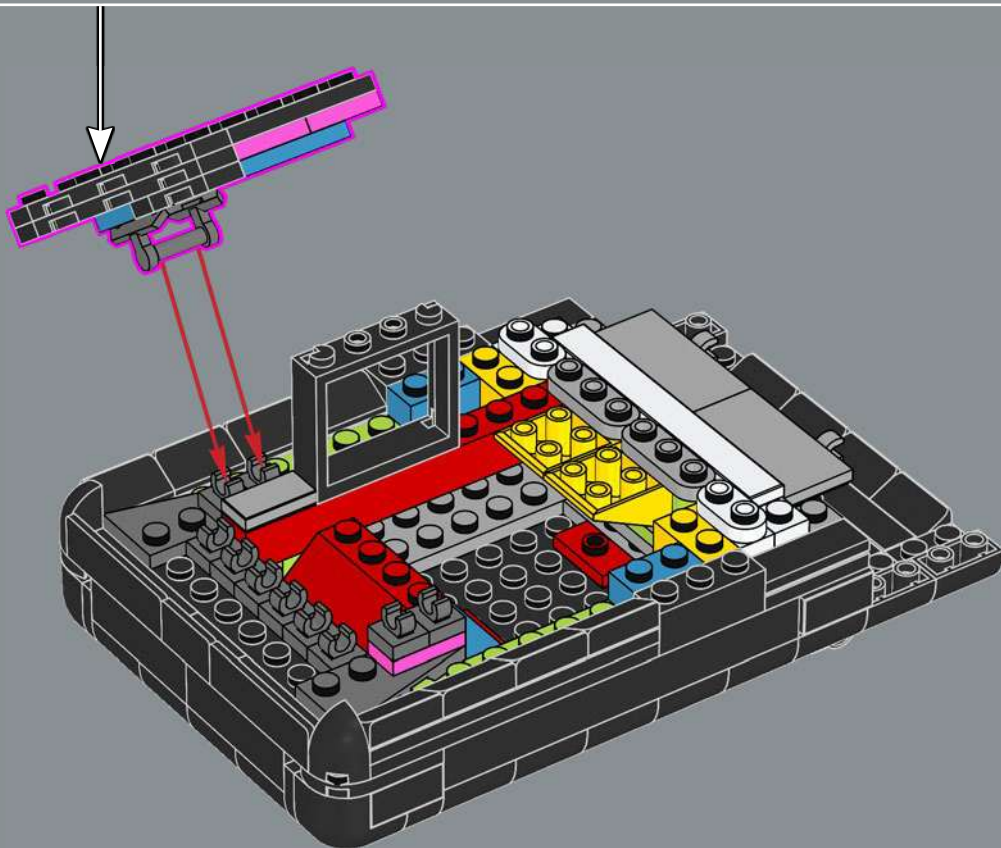
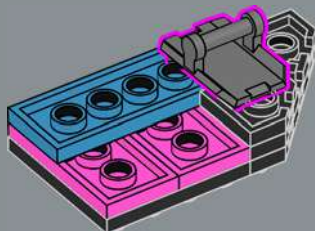

2x

48

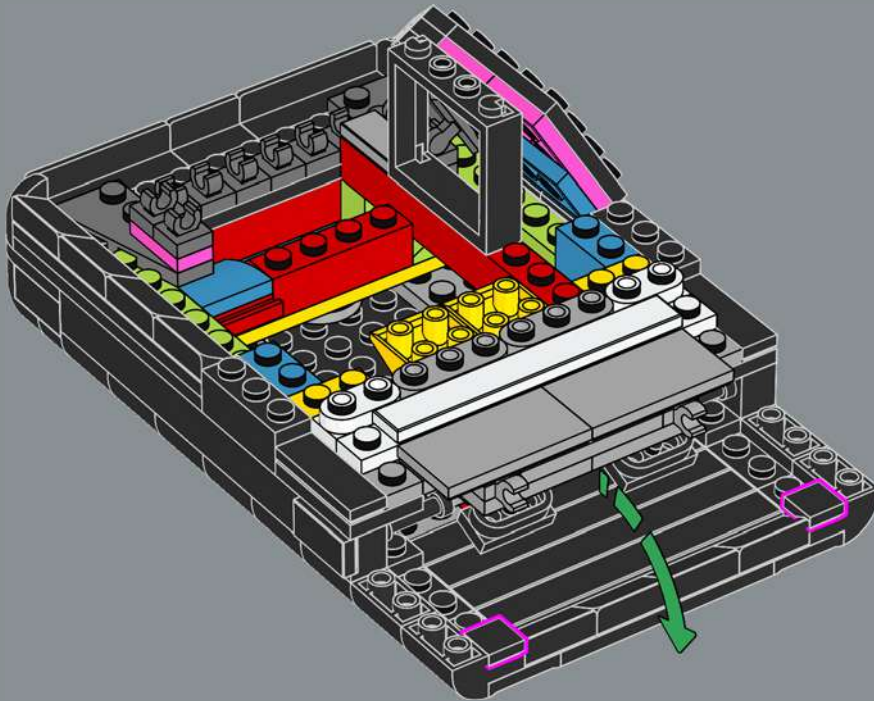

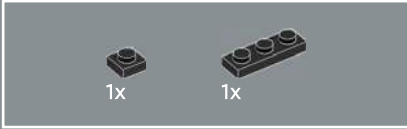
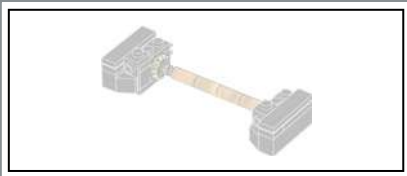

49

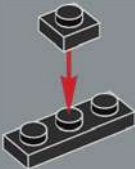

50

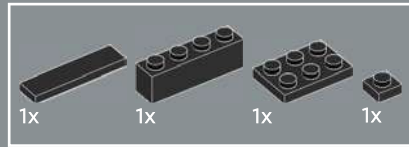
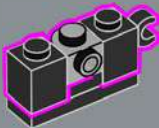

51

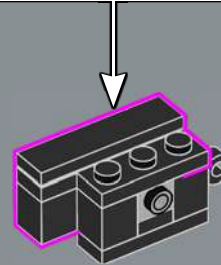
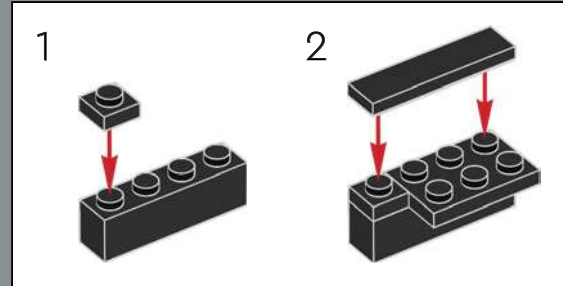

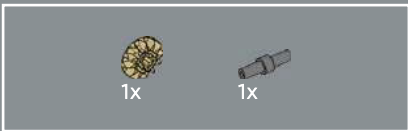

52

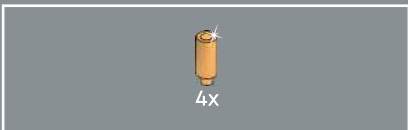
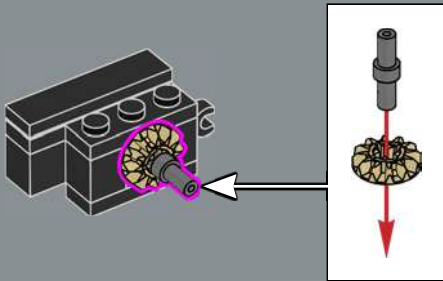

53

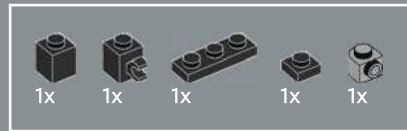
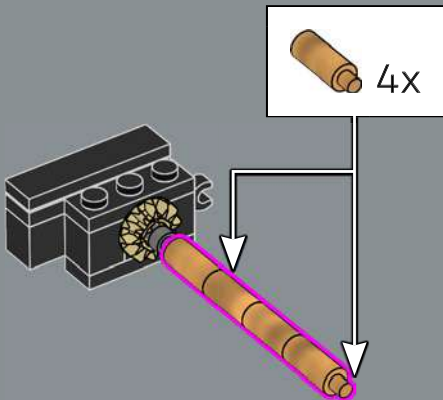

54

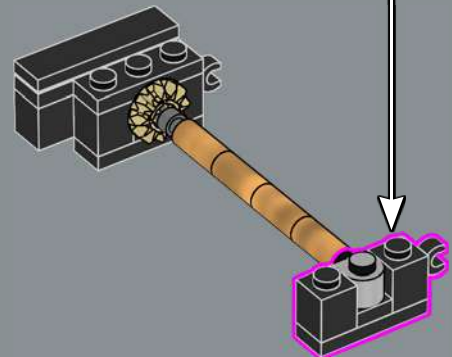
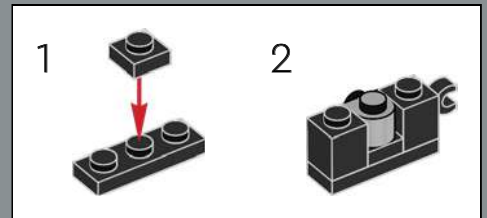

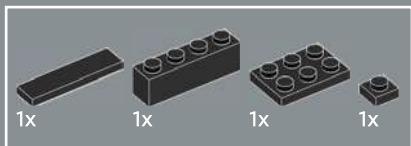

55

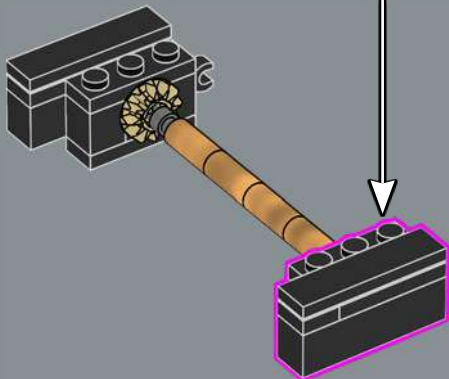
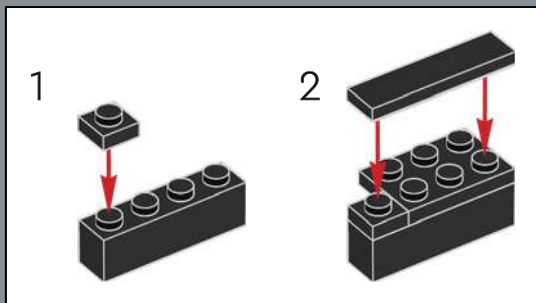

56

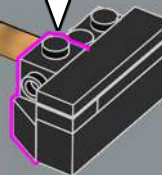
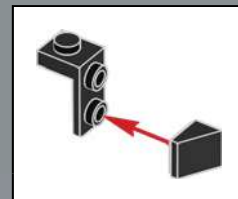
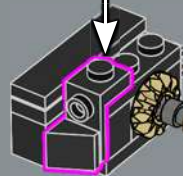
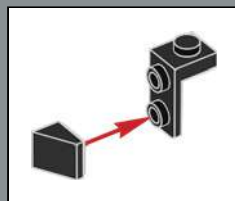

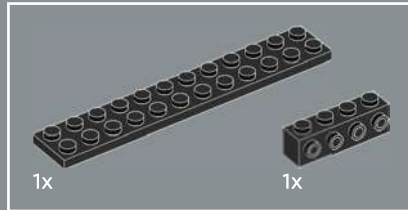
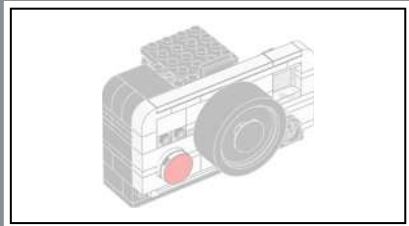
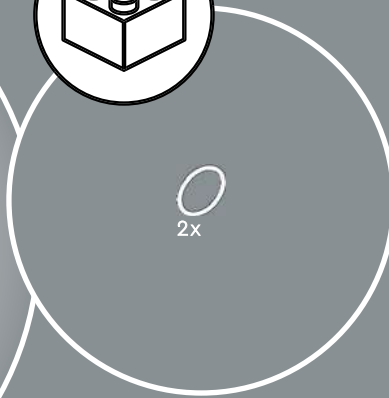
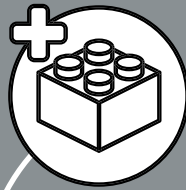

58

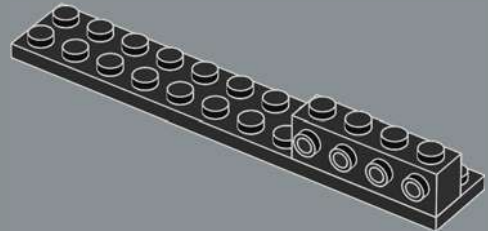

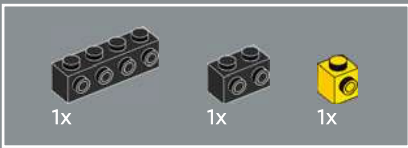

59

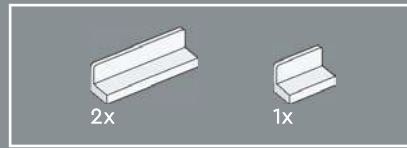
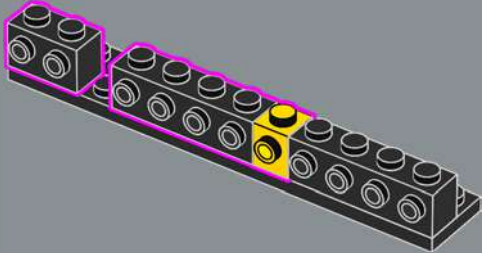

60

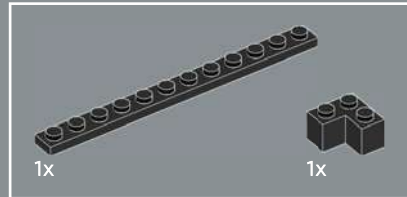
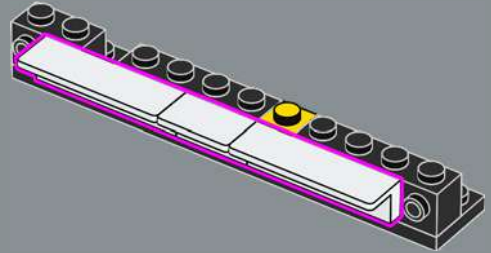

61

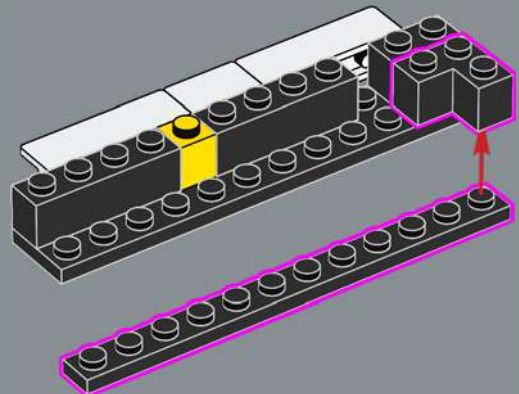

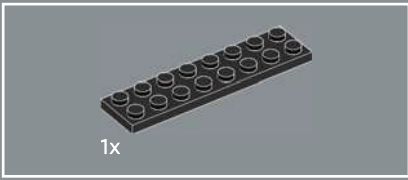

62

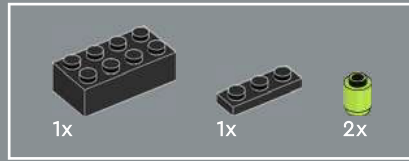
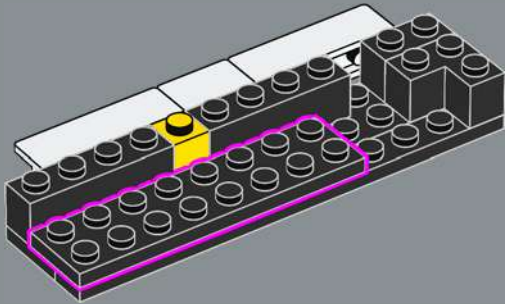

63

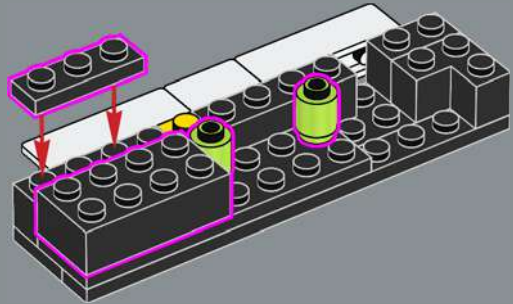

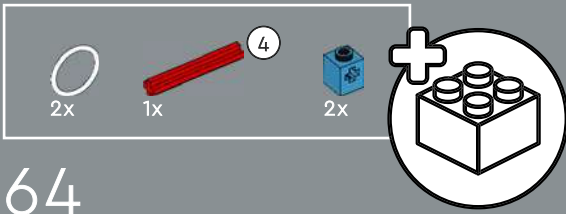

64

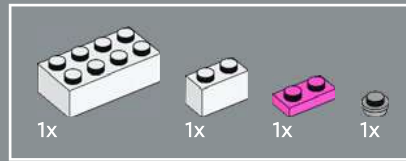
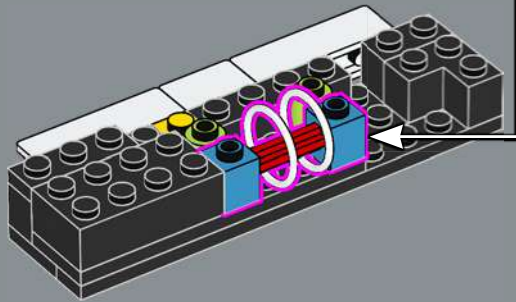
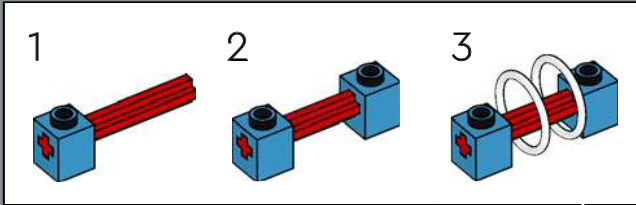

65

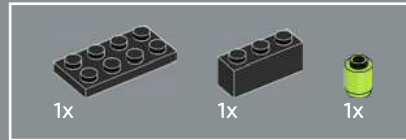
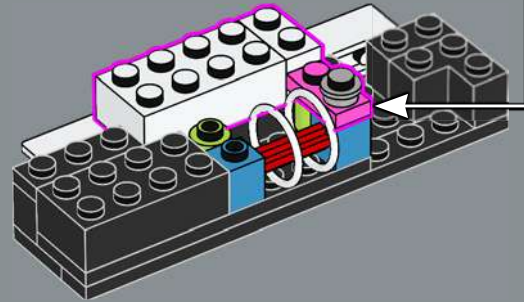
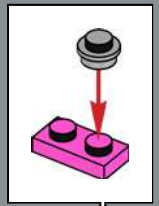

66

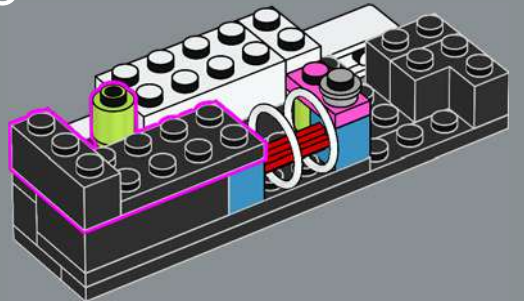

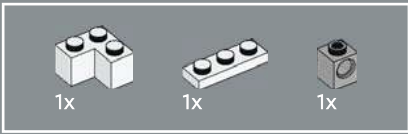

67

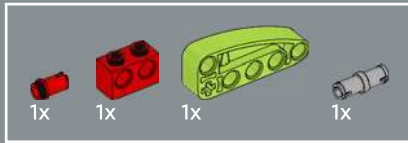
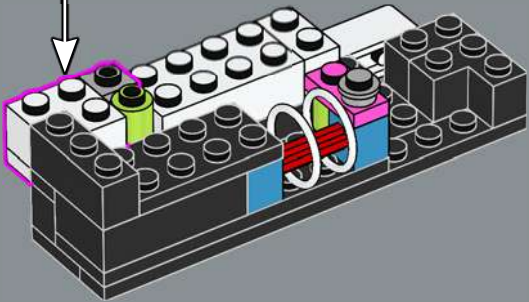
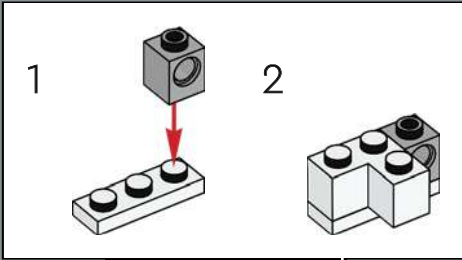

68

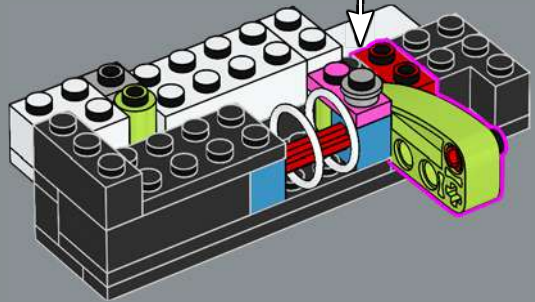
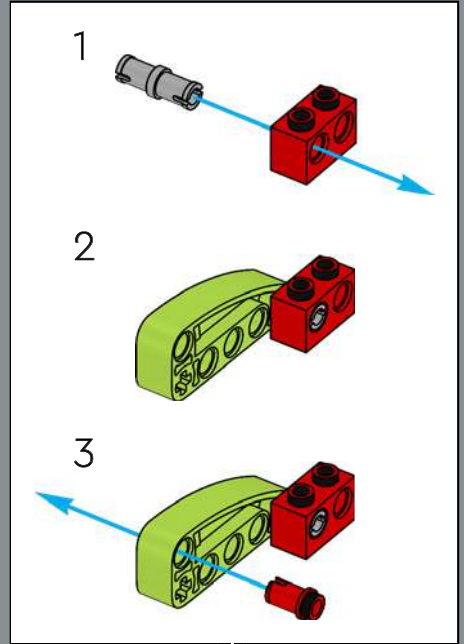

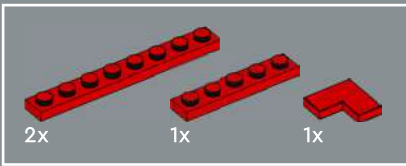

69

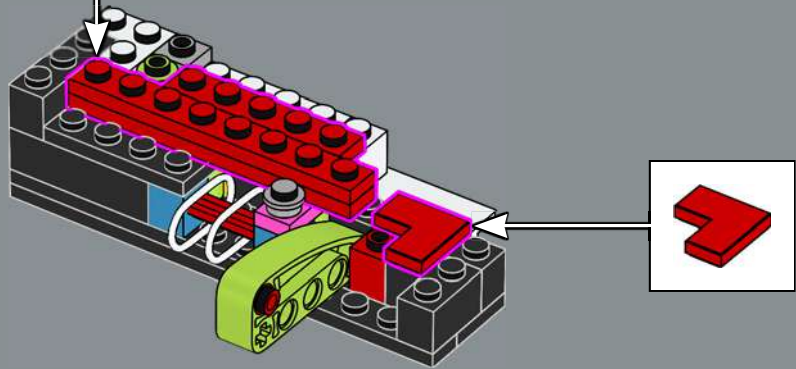
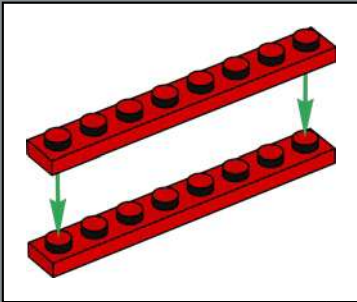

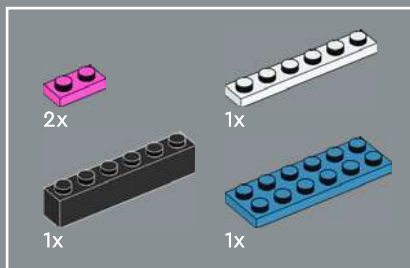

72

71

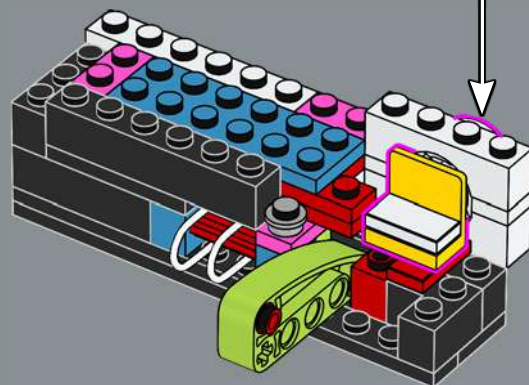
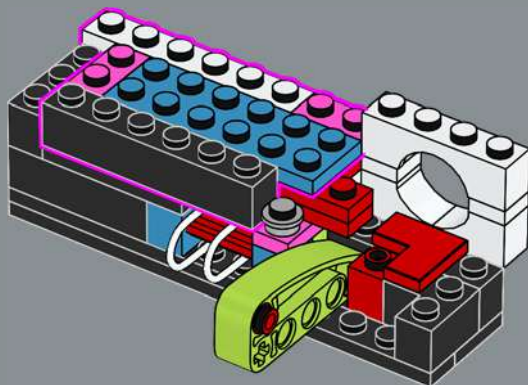
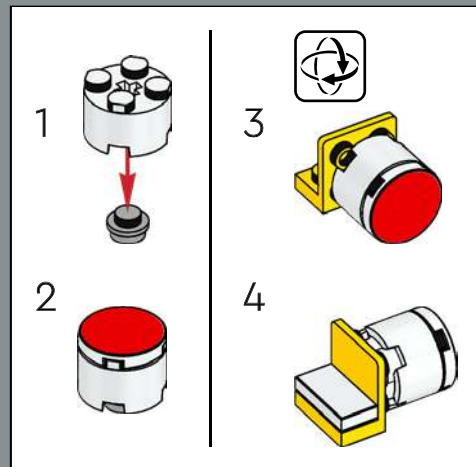

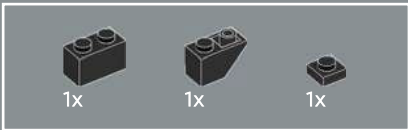

73

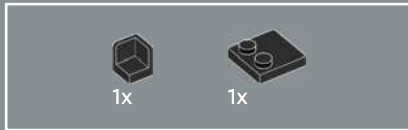
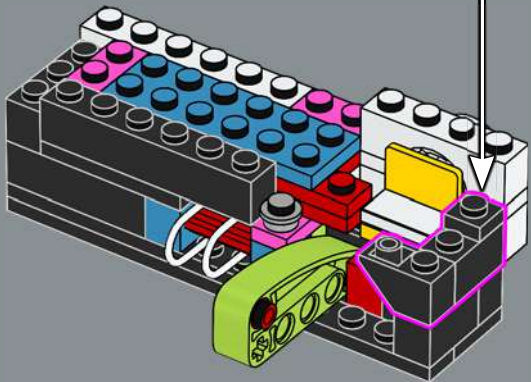
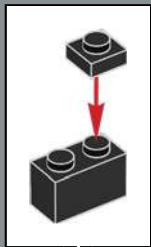

74

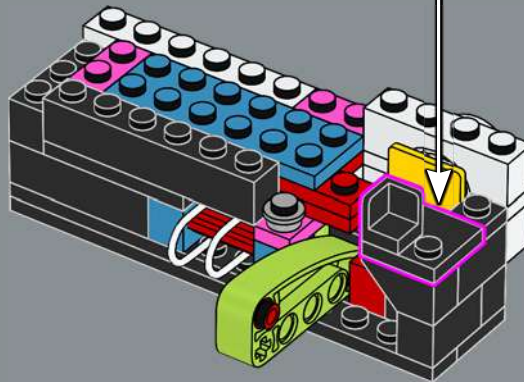
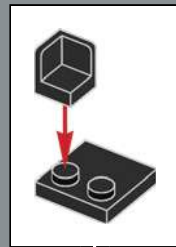

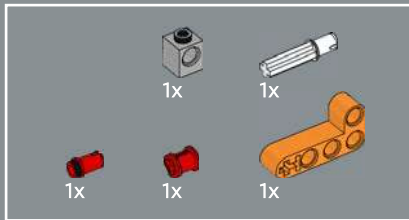

75

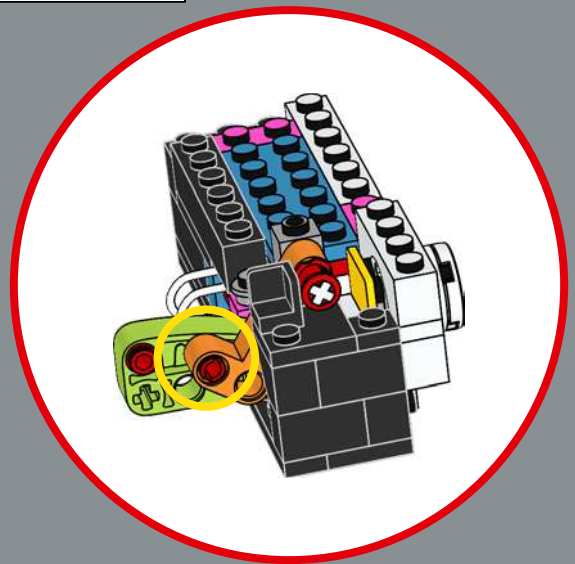
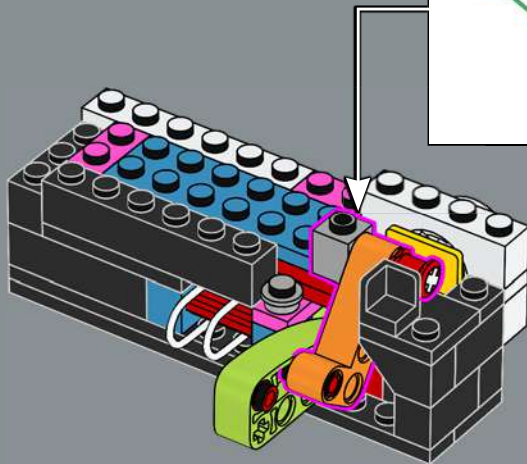
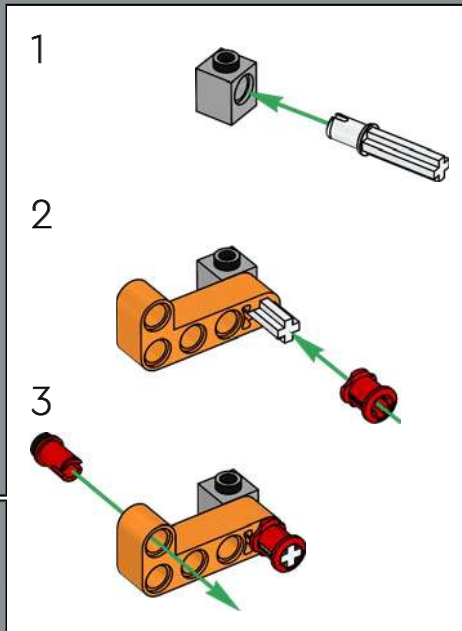



76

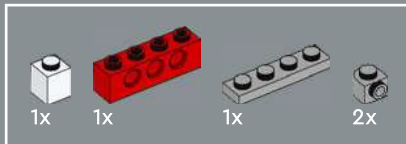
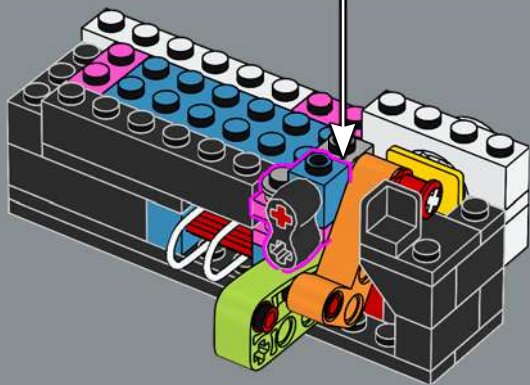

77

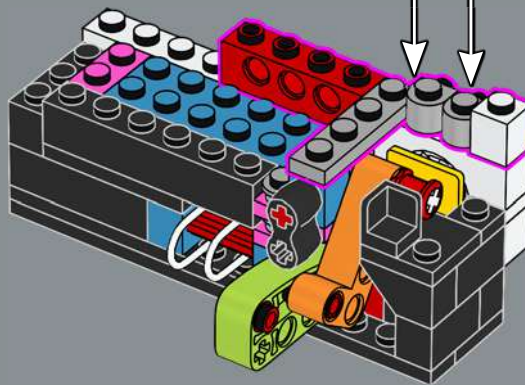

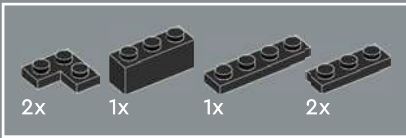

78

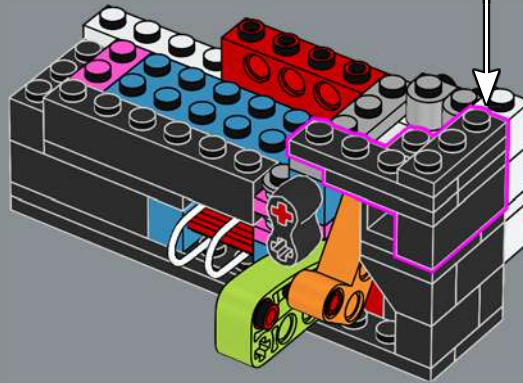
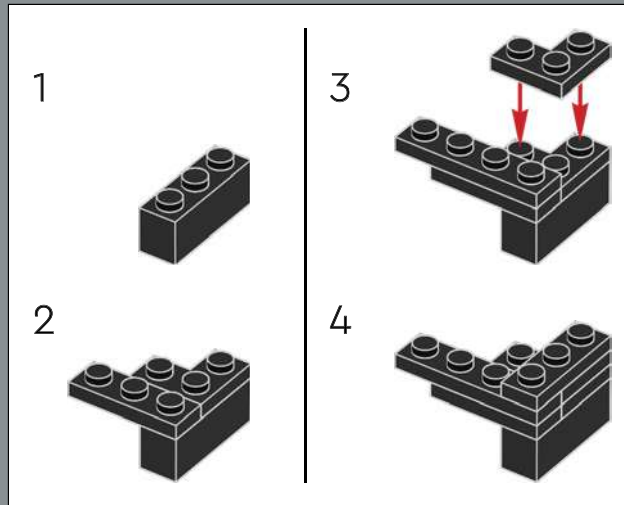

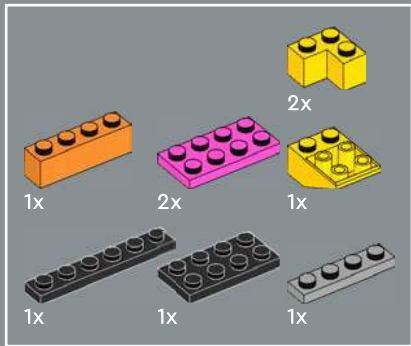

79

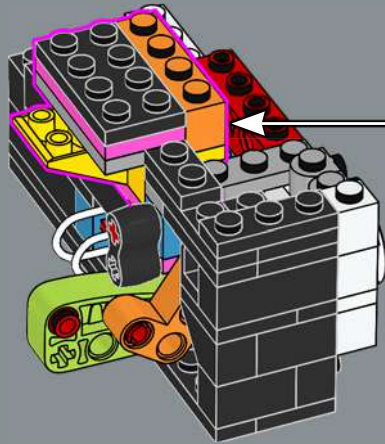
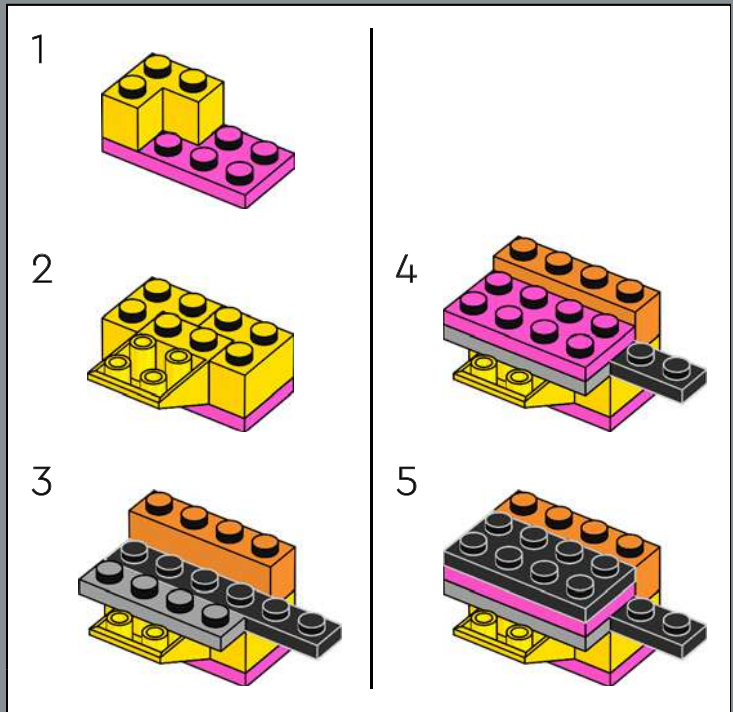

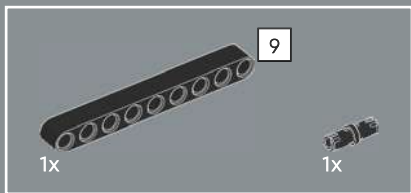

82

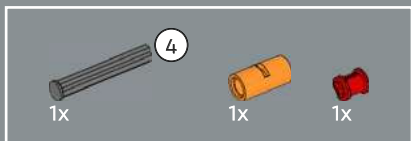
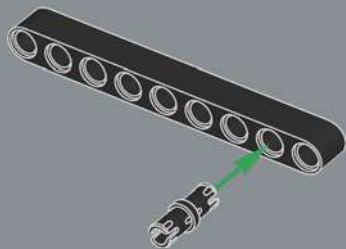

83

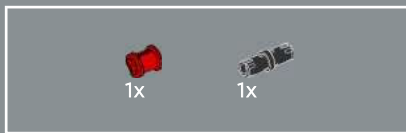
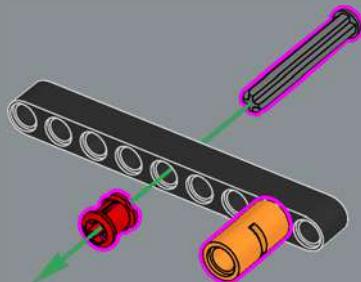

84

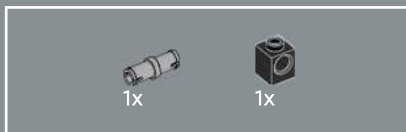
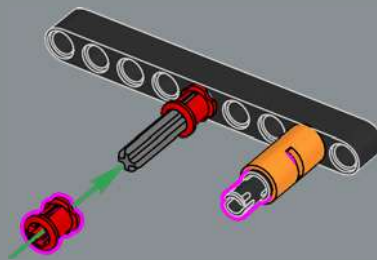

85

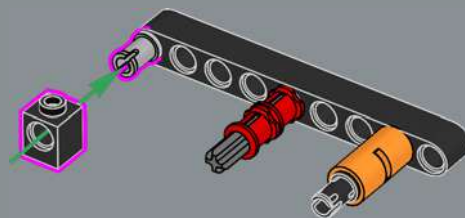

86

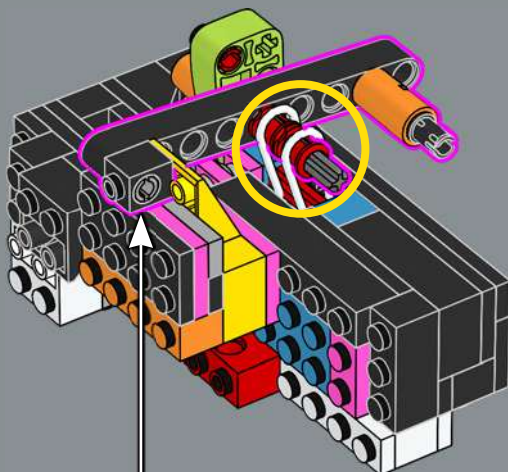

1:1

87

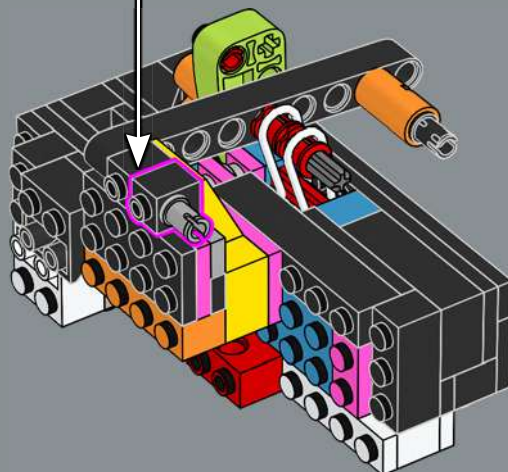
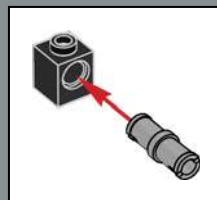



88

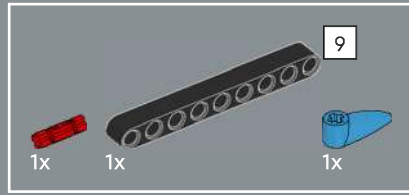
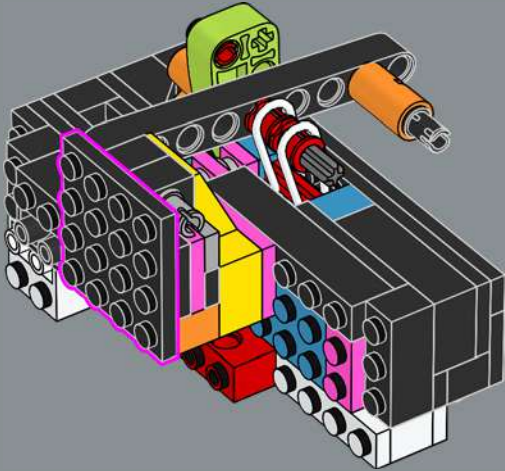

89

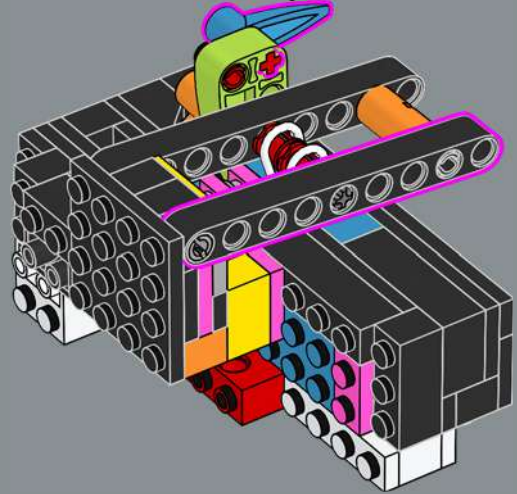
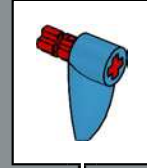

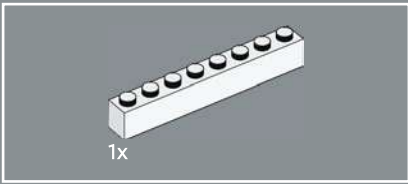

90

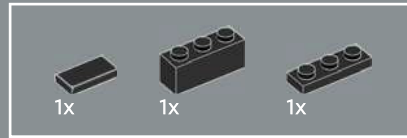
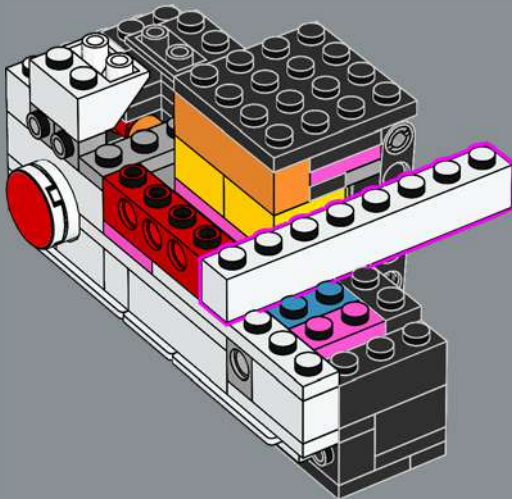

91

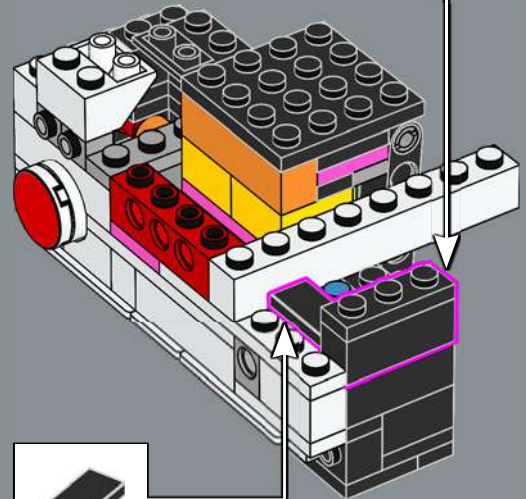
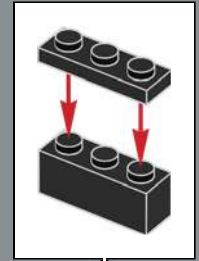

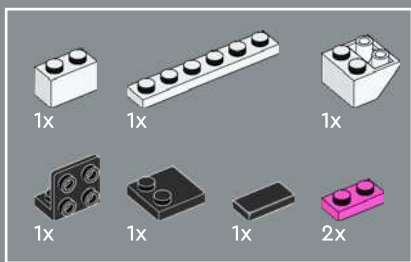

92

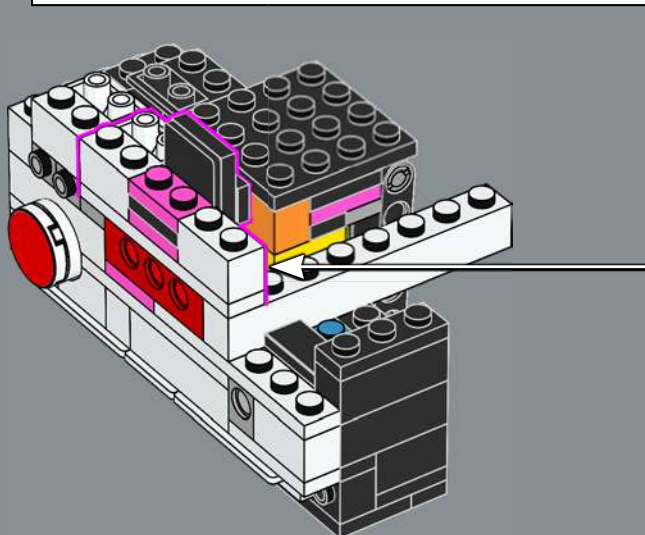
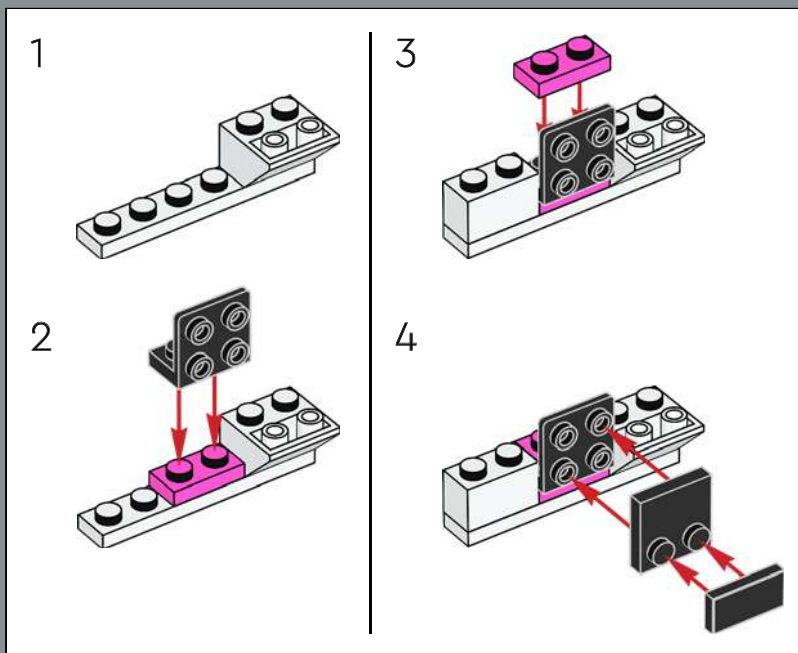

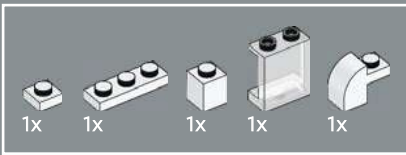

93

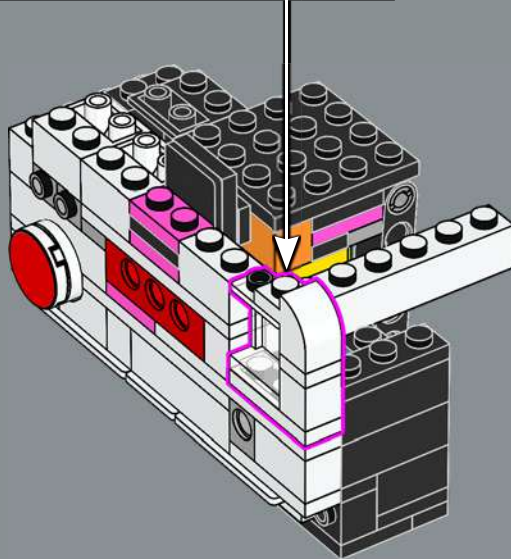
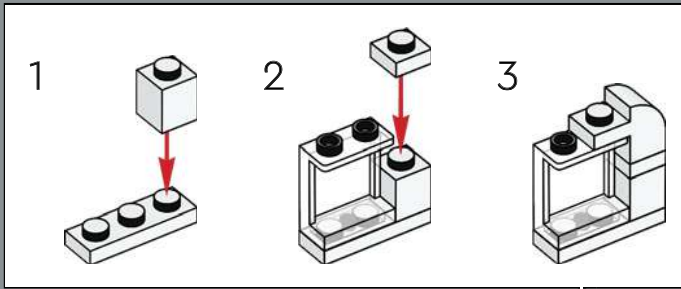

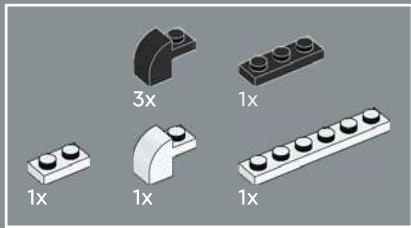

94

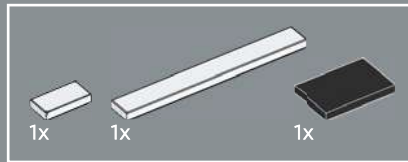
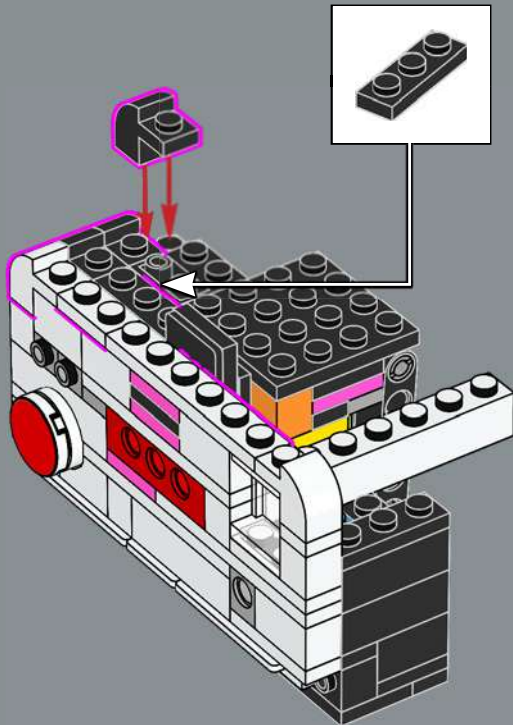

95

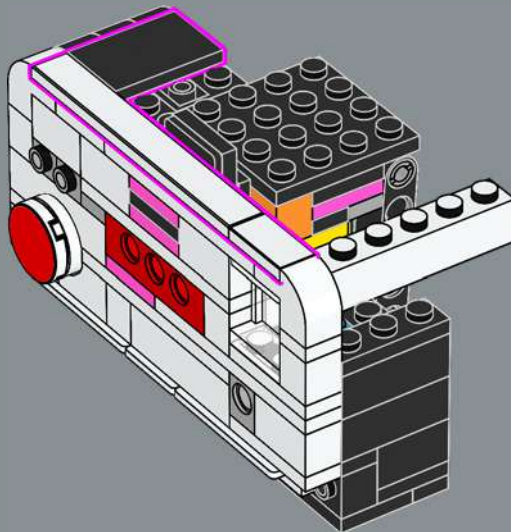



96

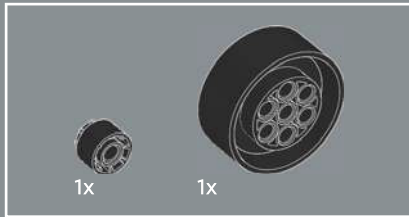
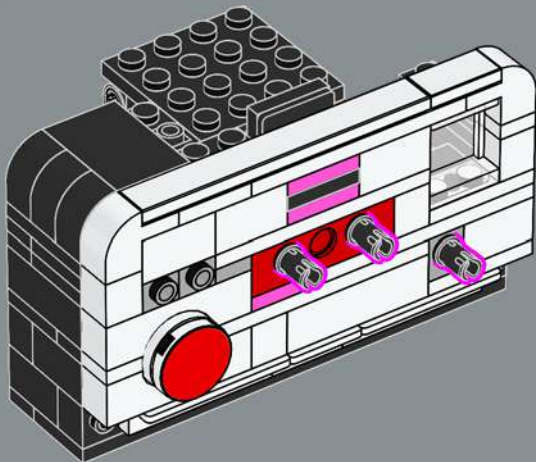

97

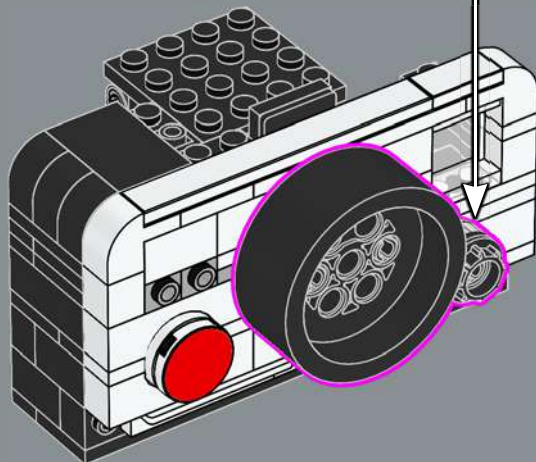
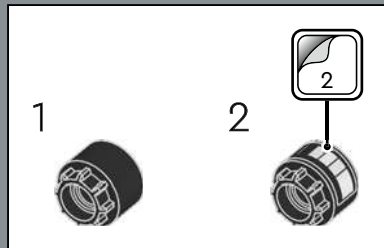



98

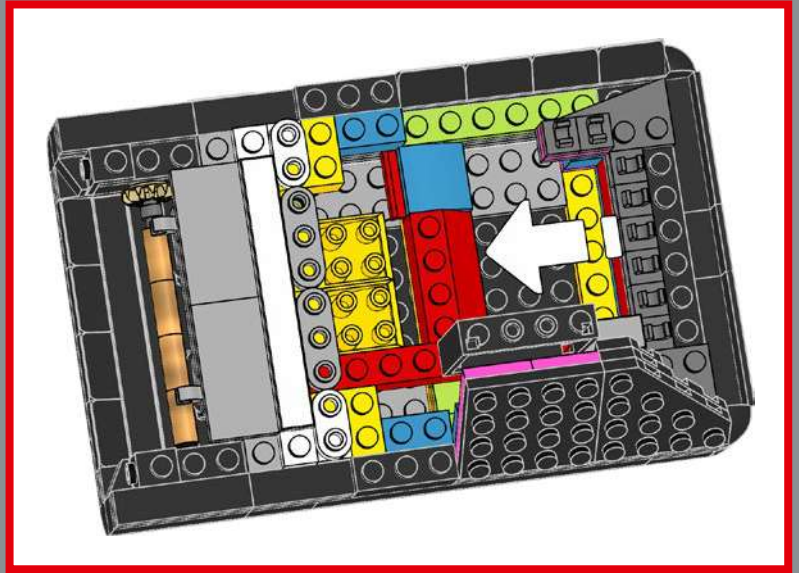
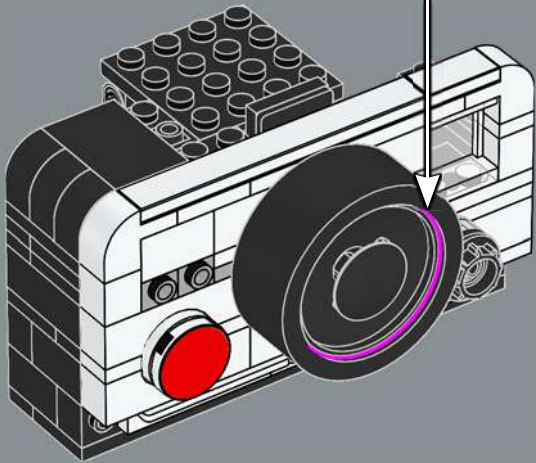
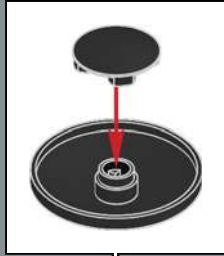

99

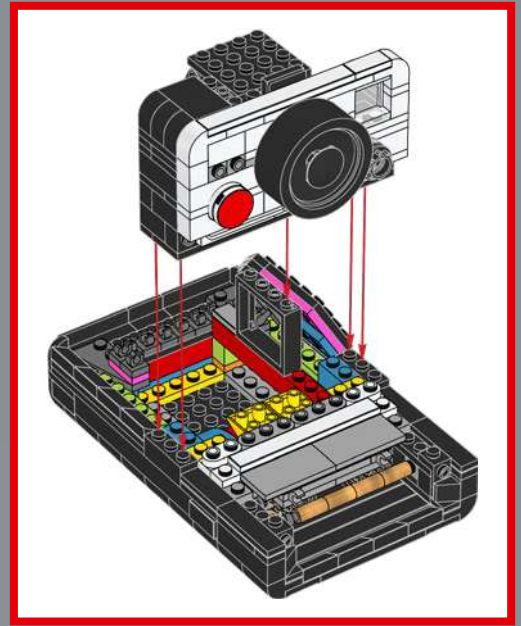
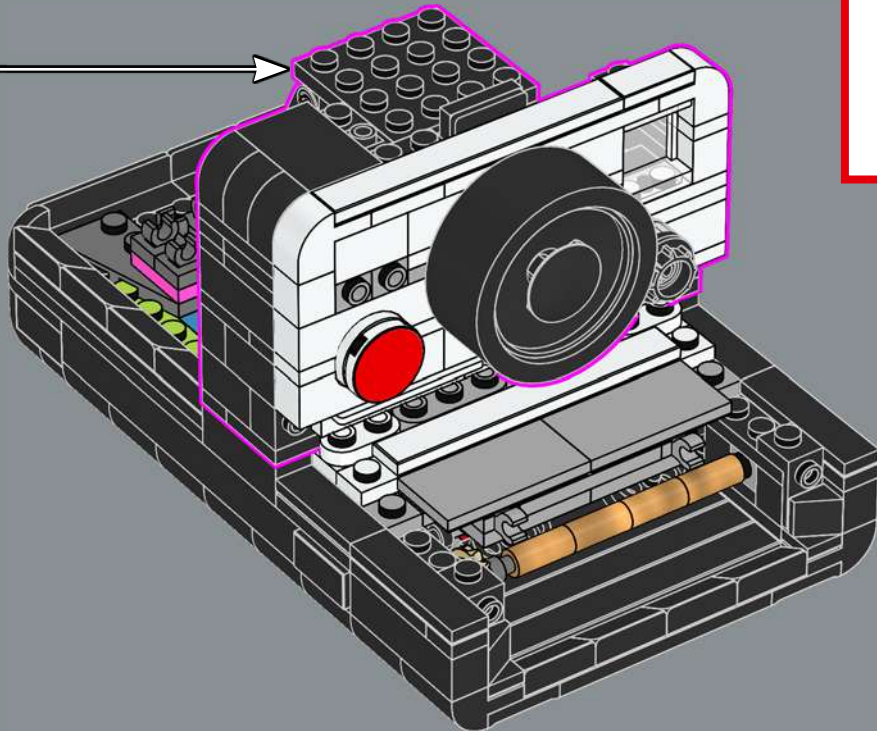

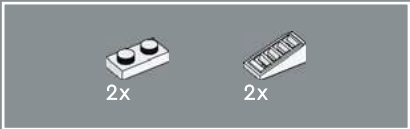

100

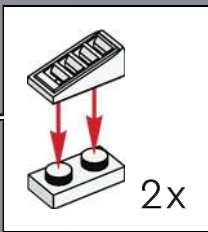
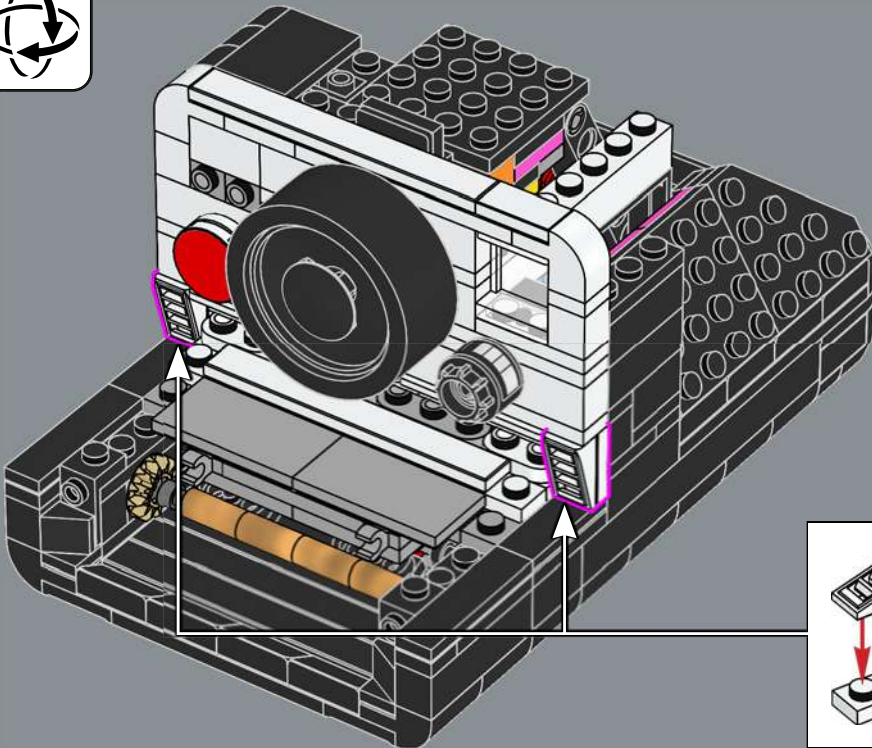



101

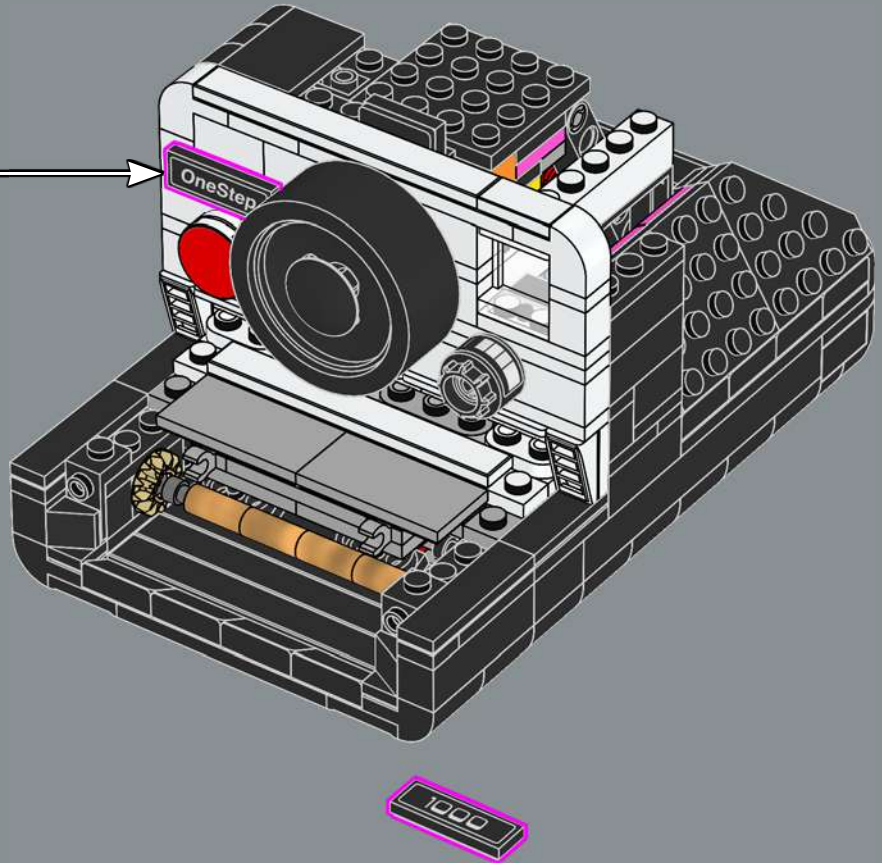
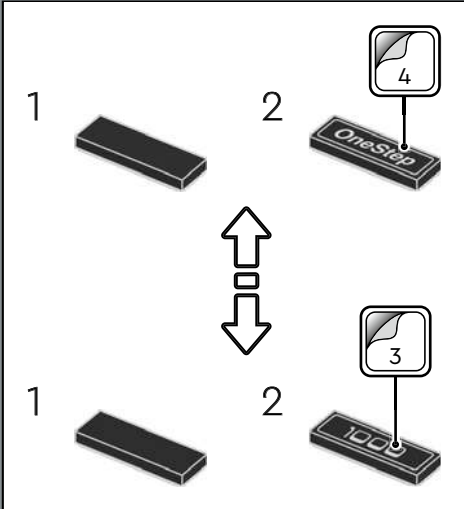

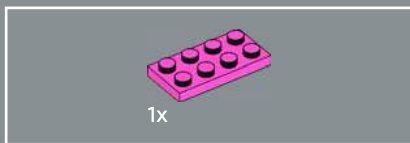

102

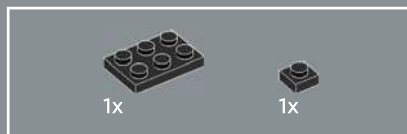
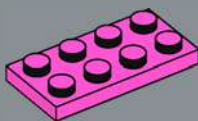

103

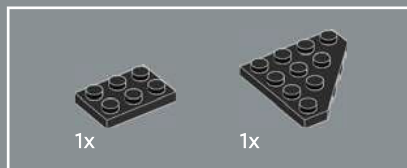

104

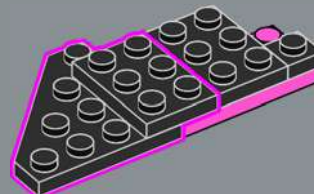



105

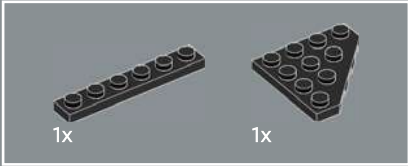
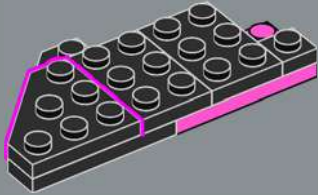

106

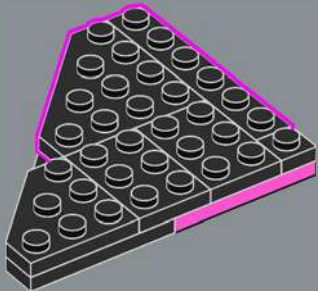

107

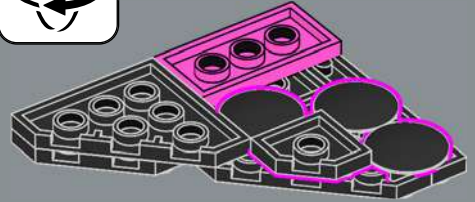

108

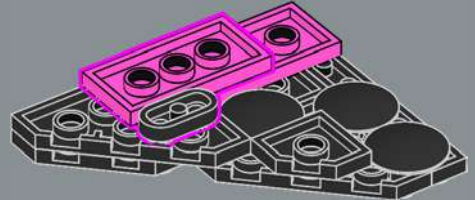



109

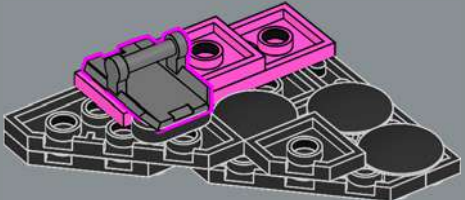

110

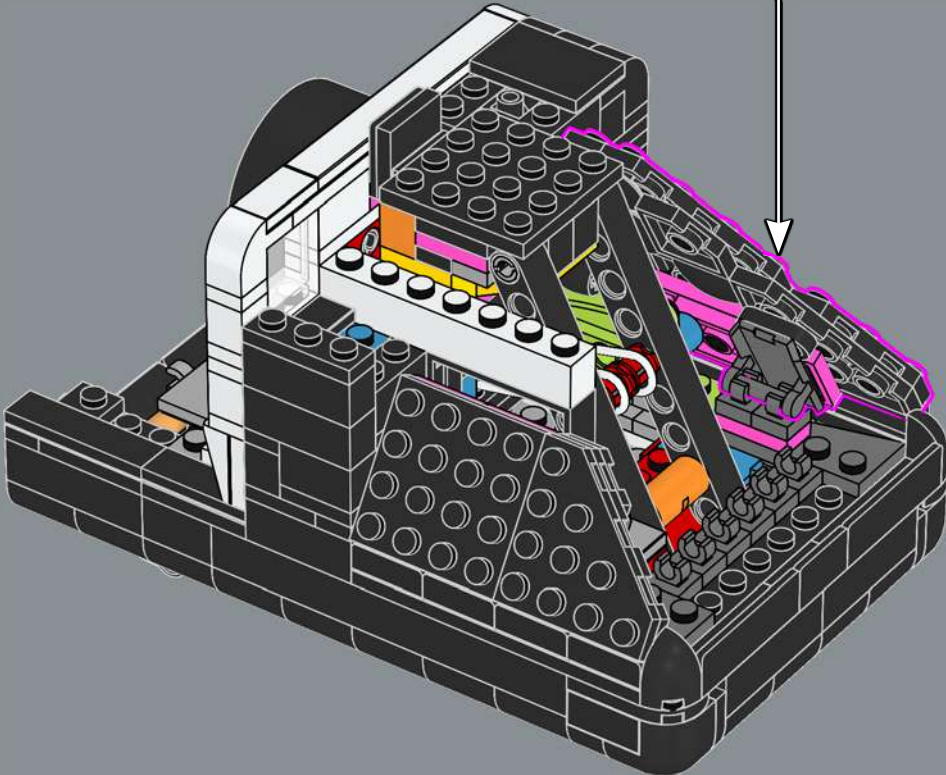

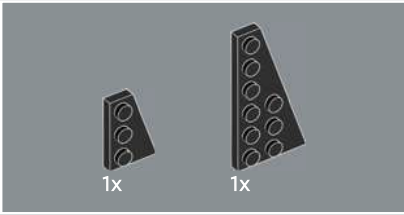

111

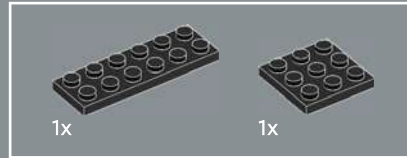
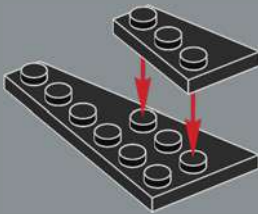

112

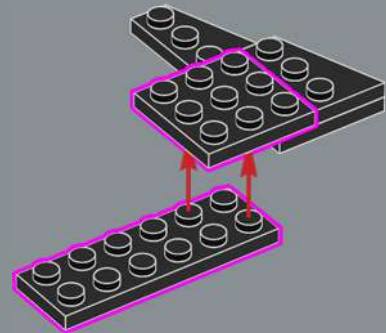

113

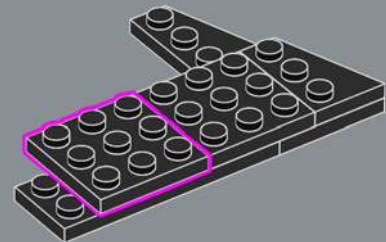

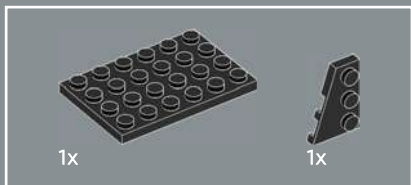

114

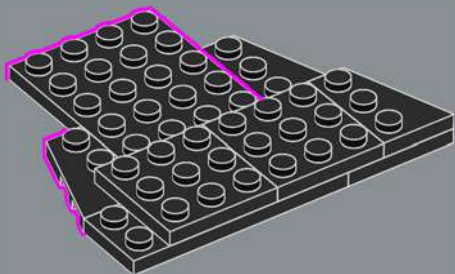

115

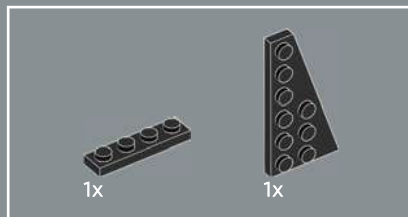
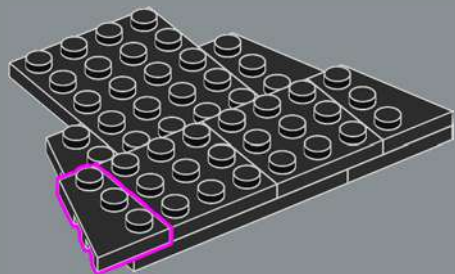

116

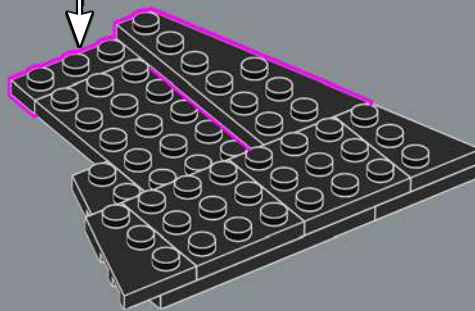
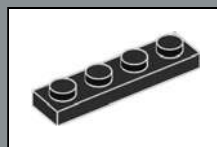



117

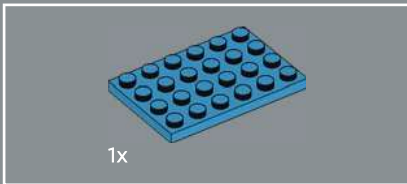
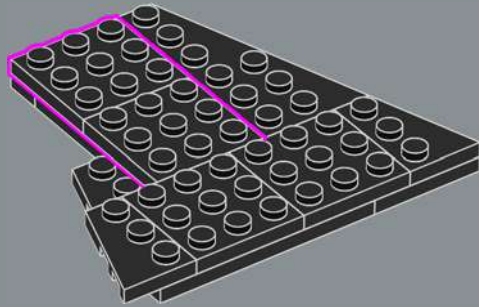

118

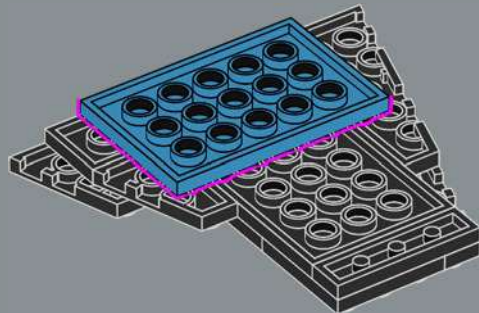

119

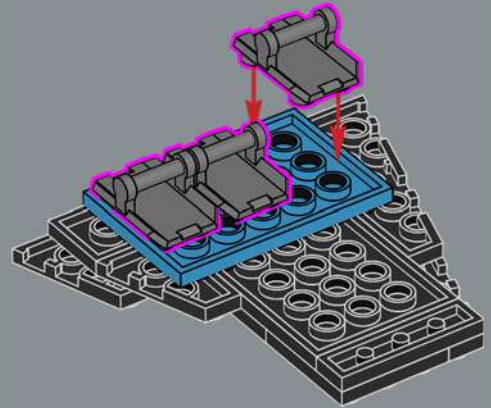

120

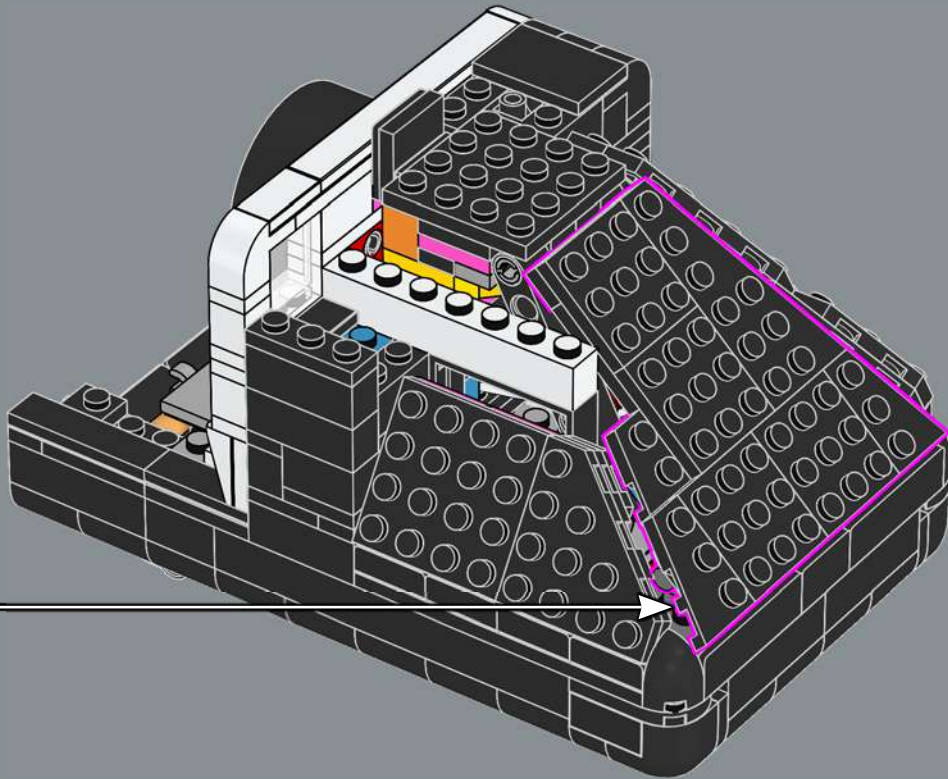

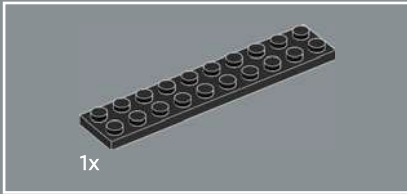
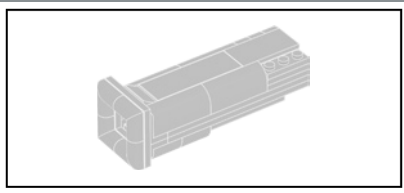

121

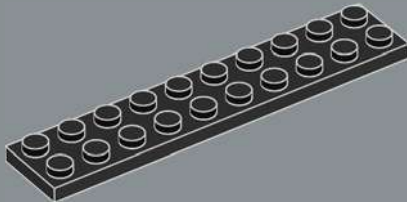

122

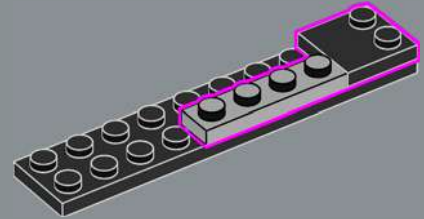

123

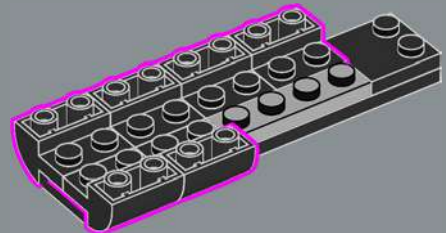

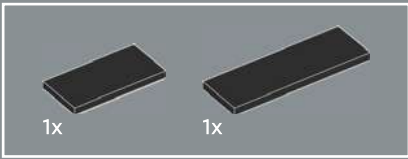

124

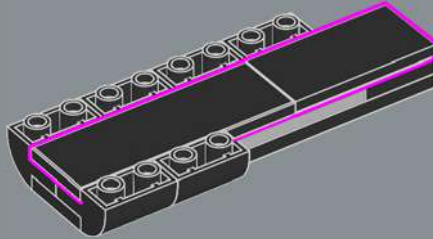

125

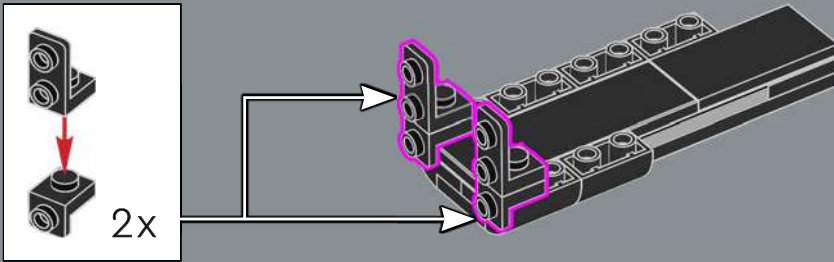

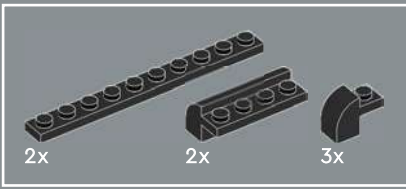

126

1

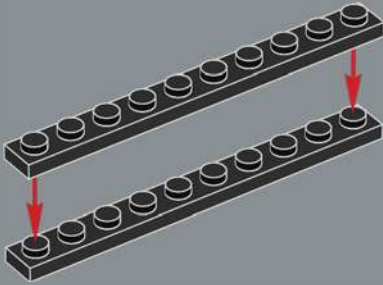

2

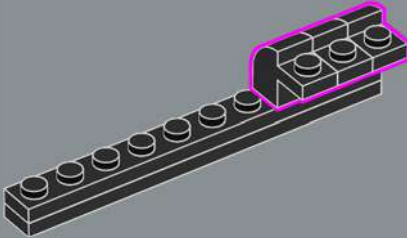

3

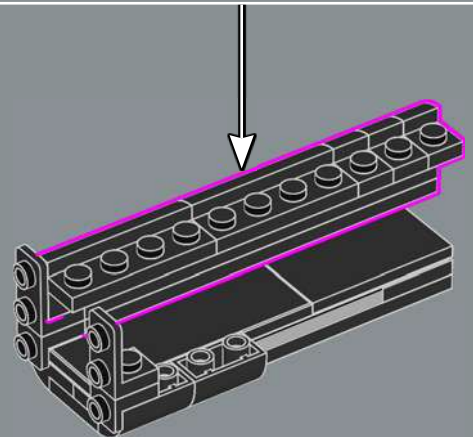
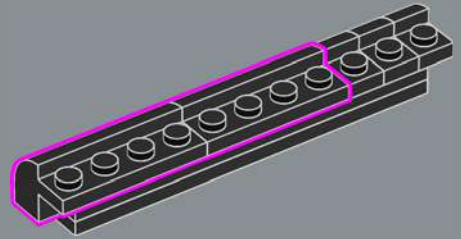

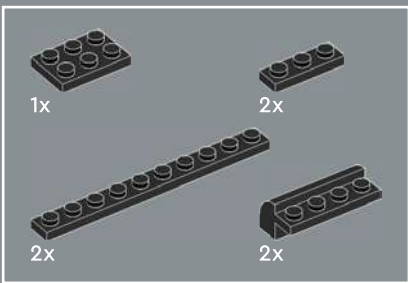

127

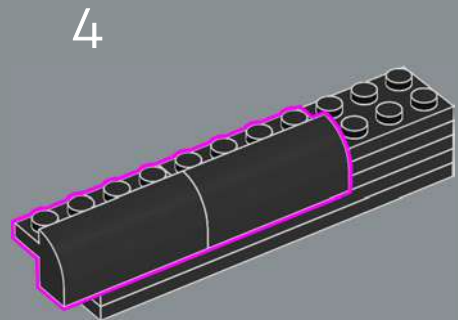
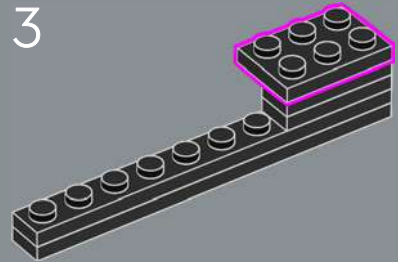
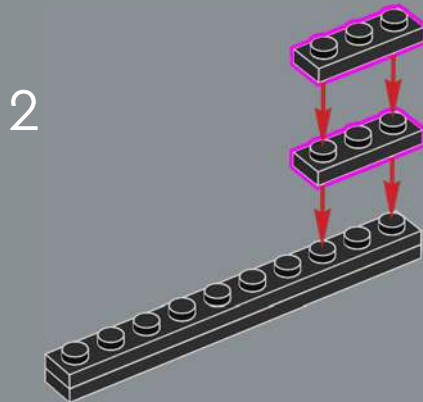
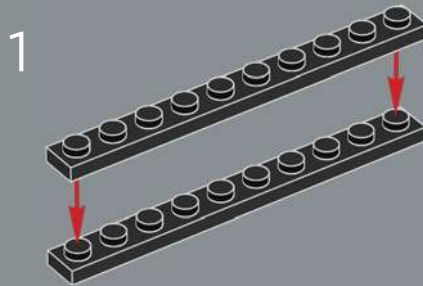

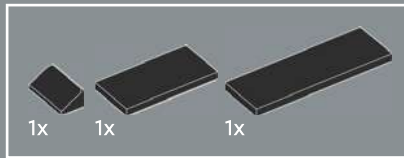

128

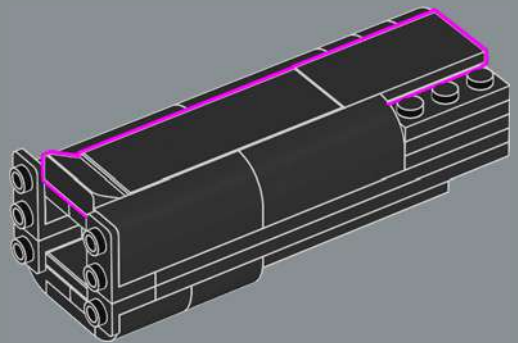
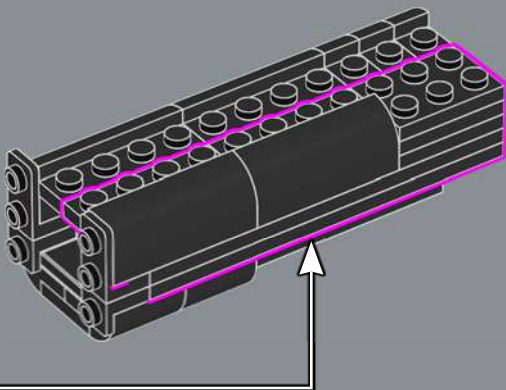

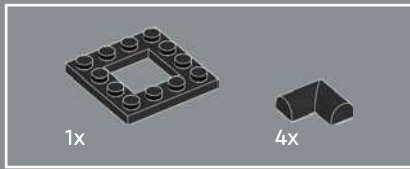

129

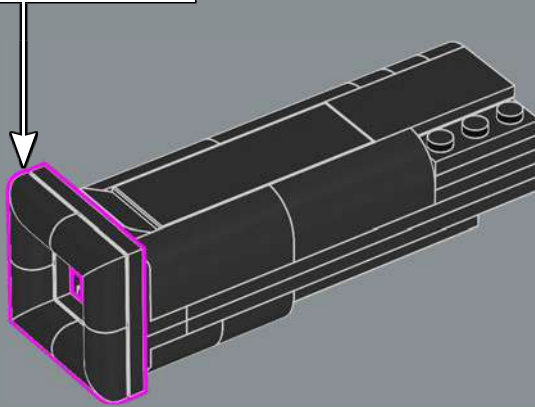
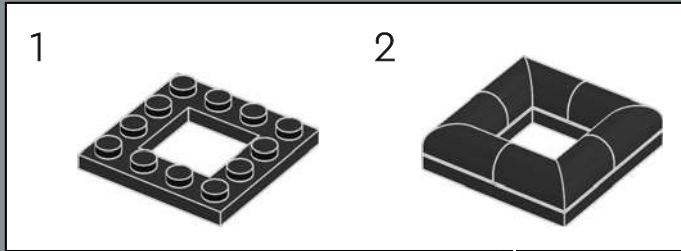

130

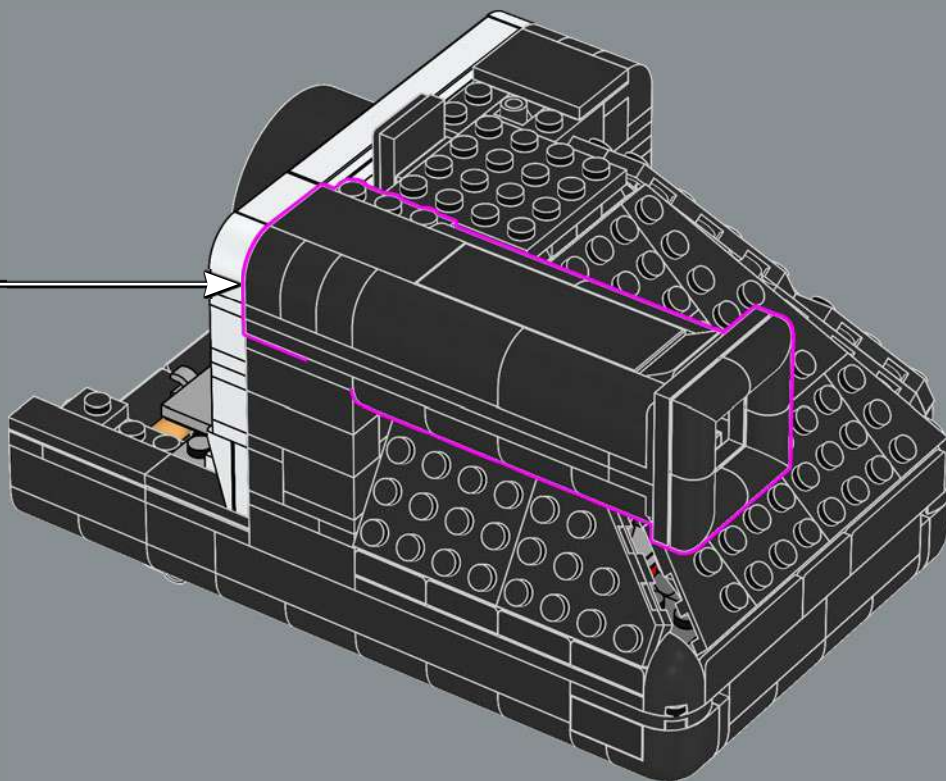

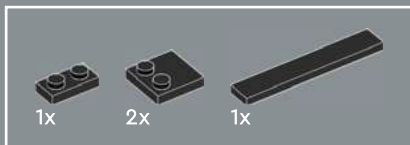

131

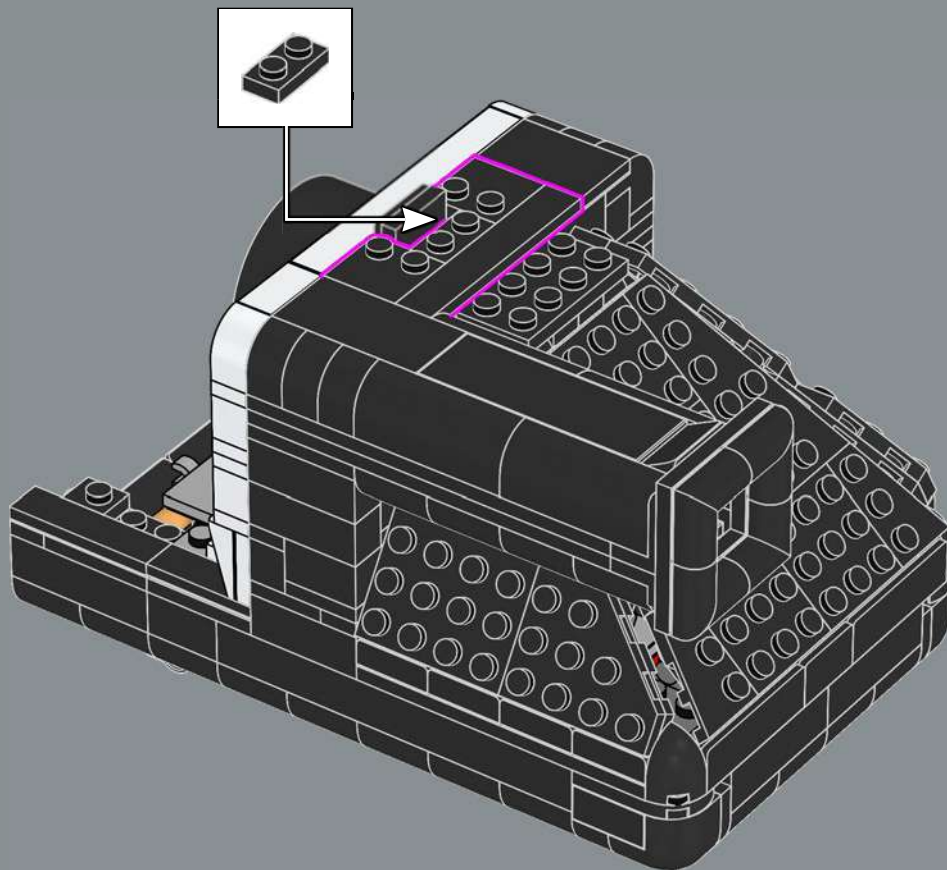

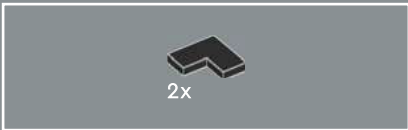

132

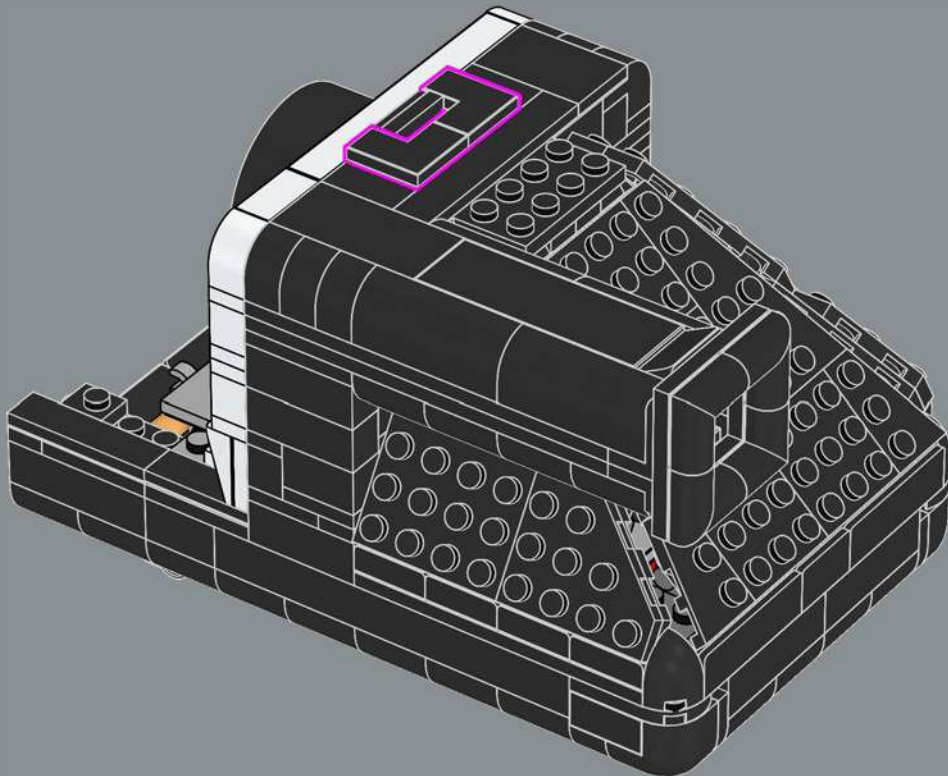

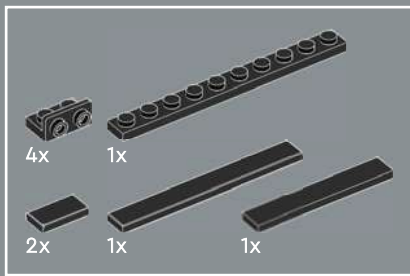

133

1

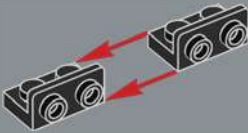

2

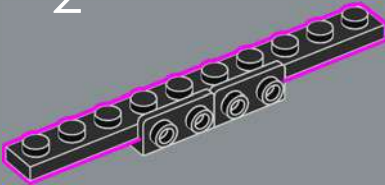

3

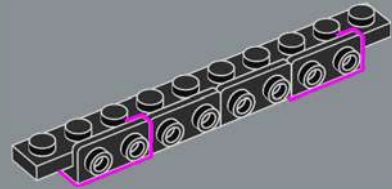

4

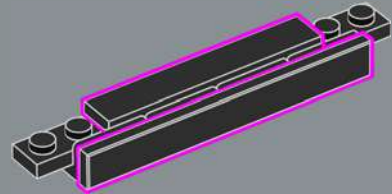



5

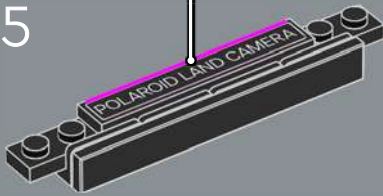

6

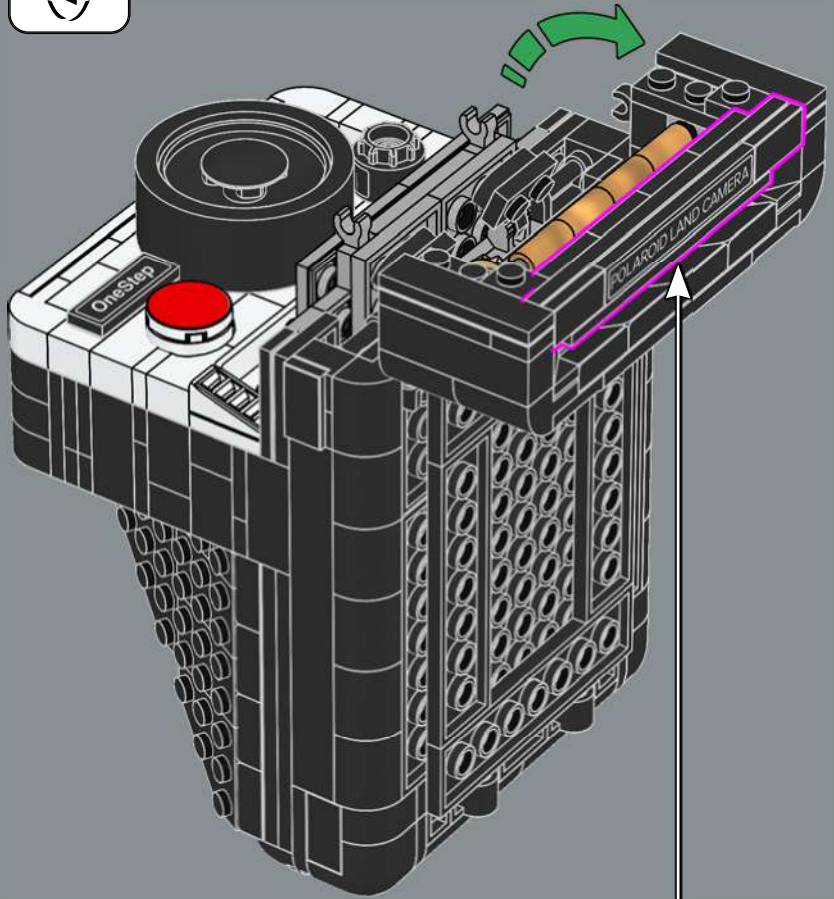
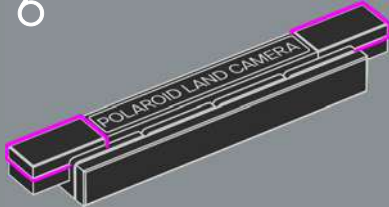

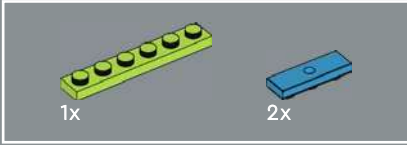
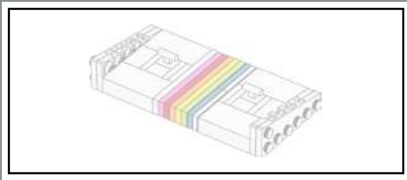

134

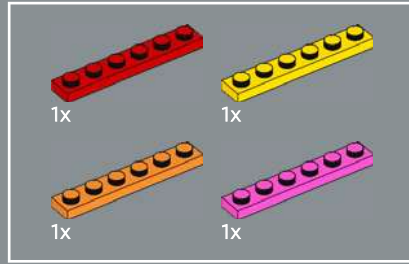
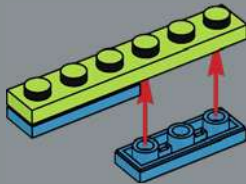

135

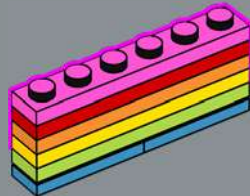

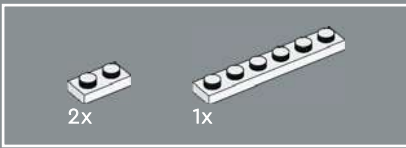

136

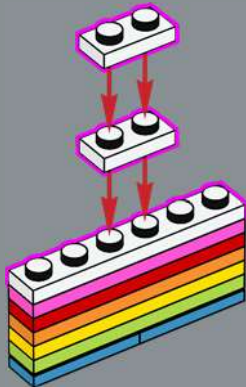

137

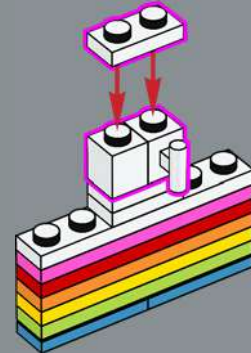

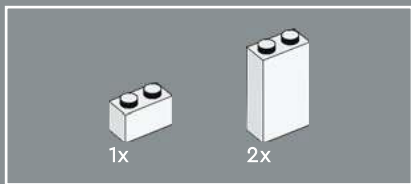

138

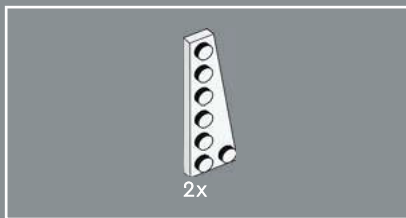
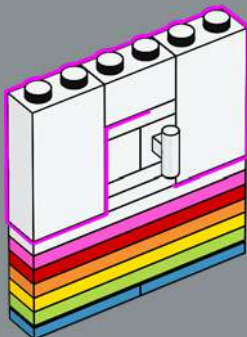

139

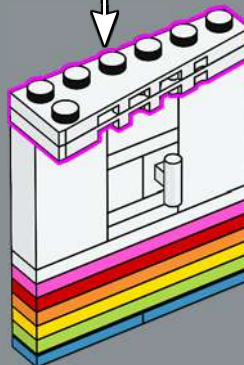
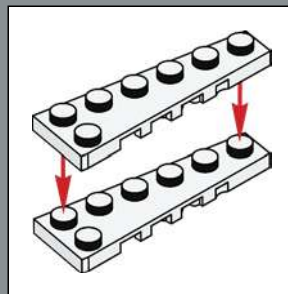

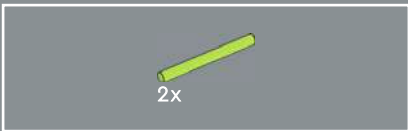

140

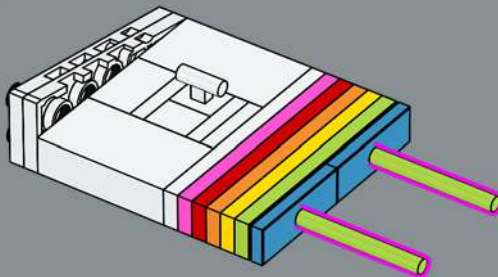

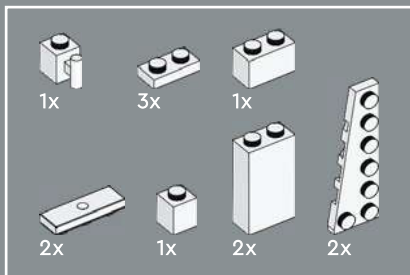

141

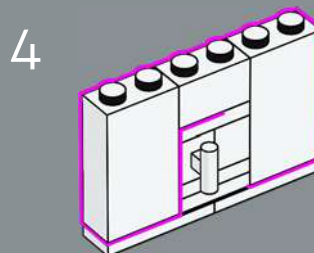
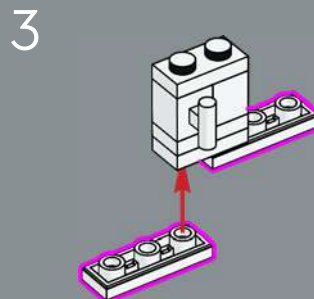
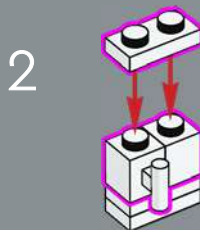
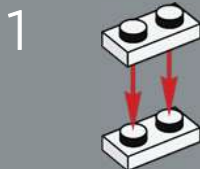

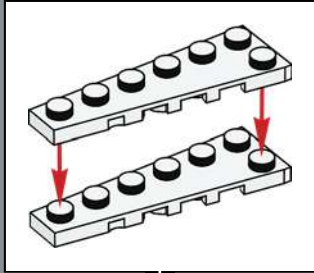

5

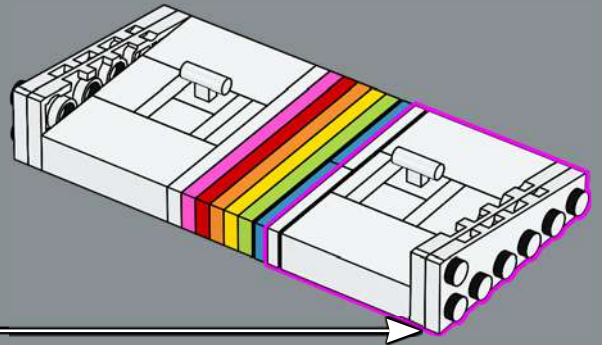
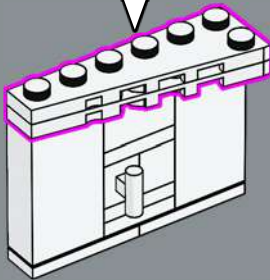

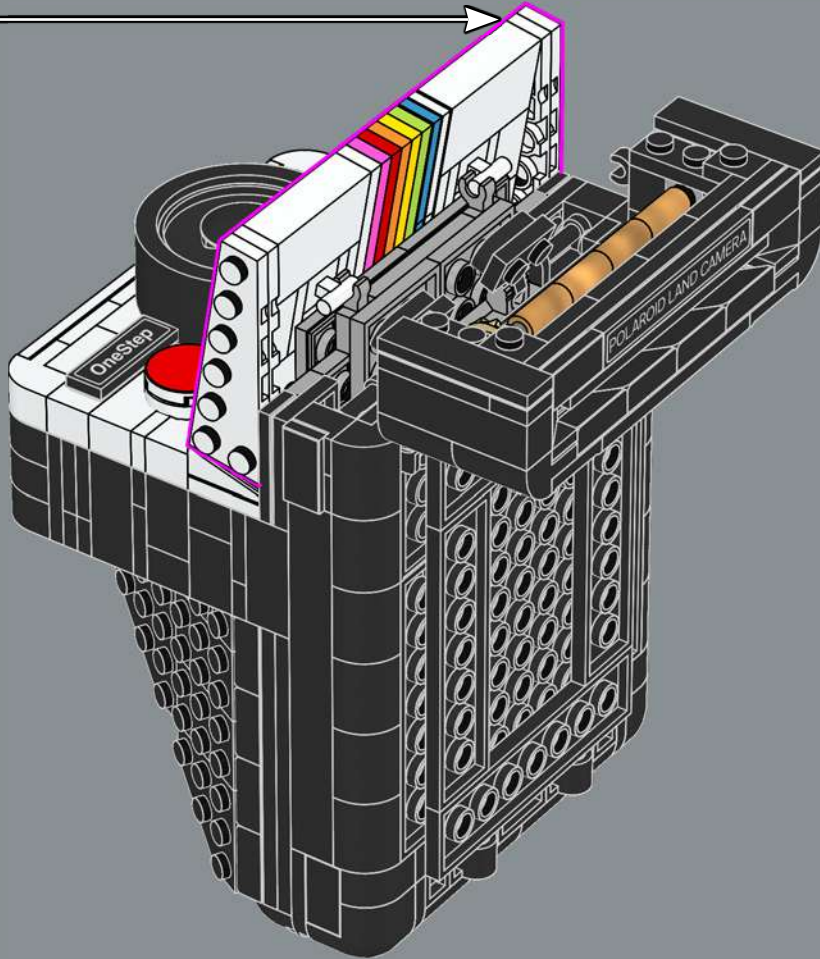

143

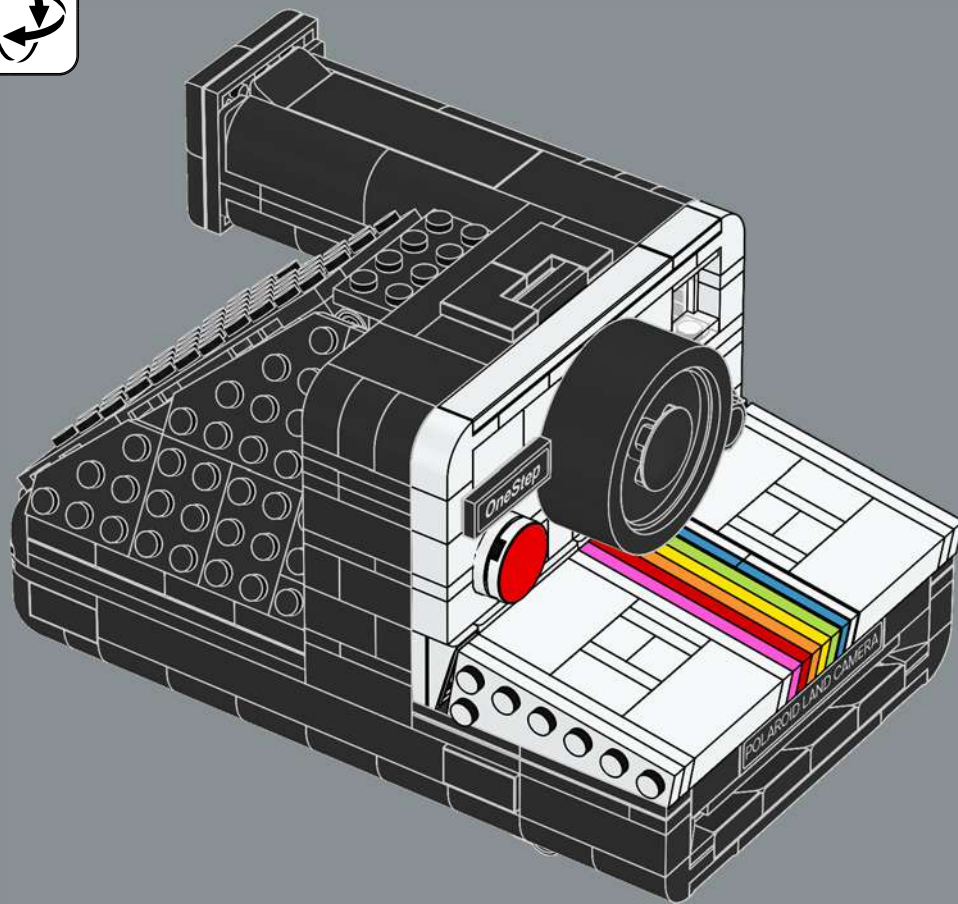

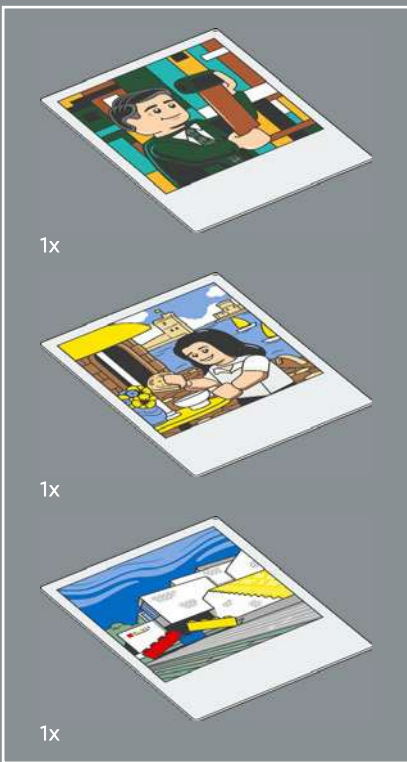

144

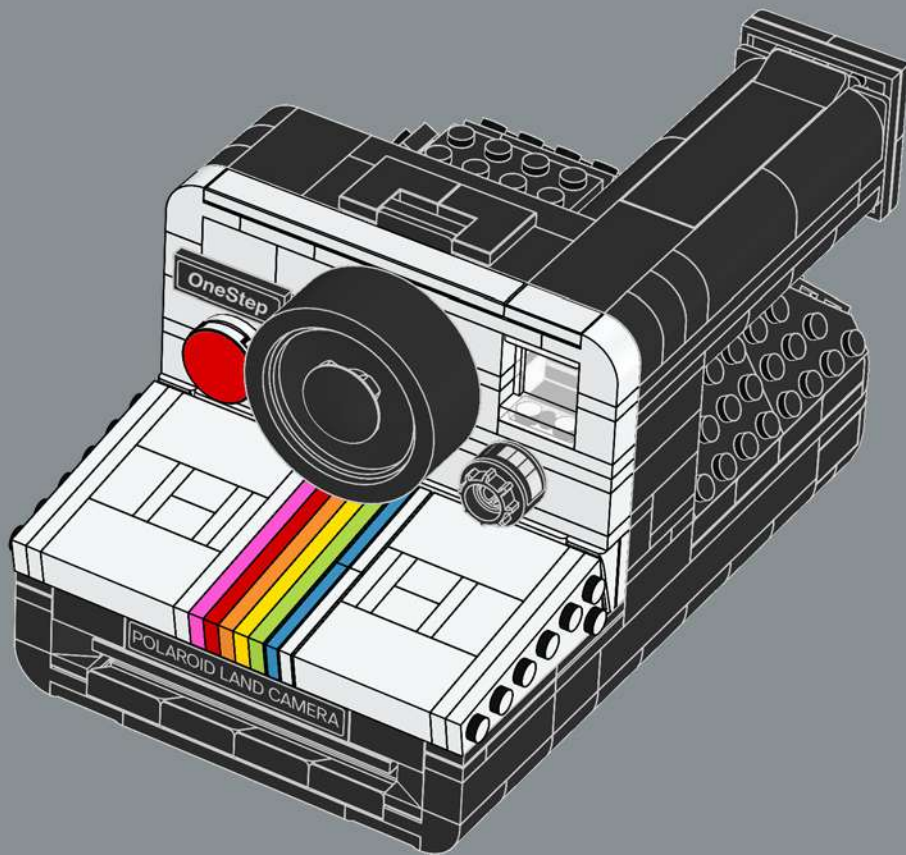



1

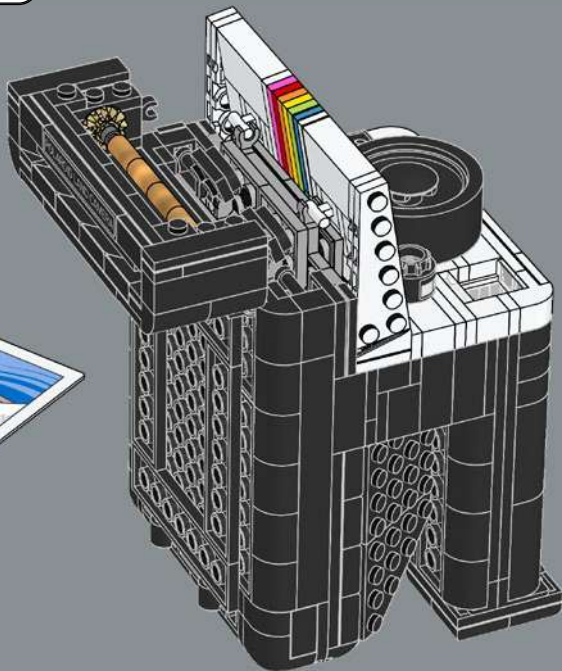
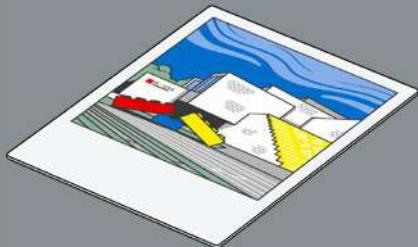



2

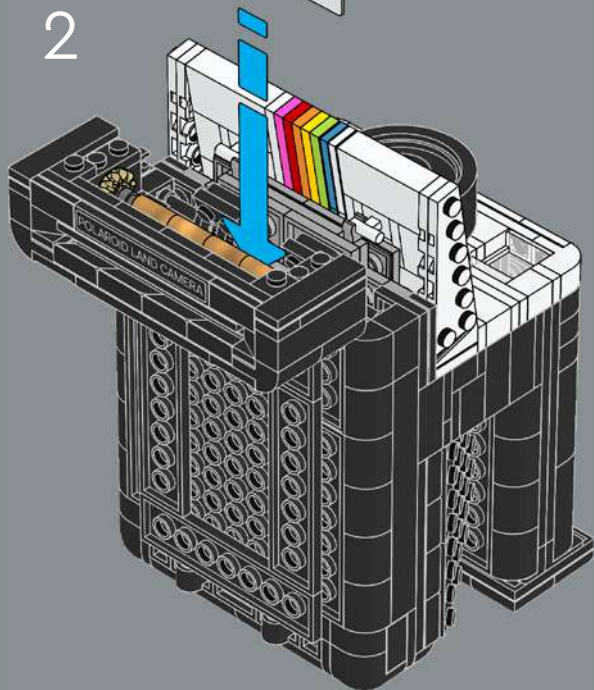

3

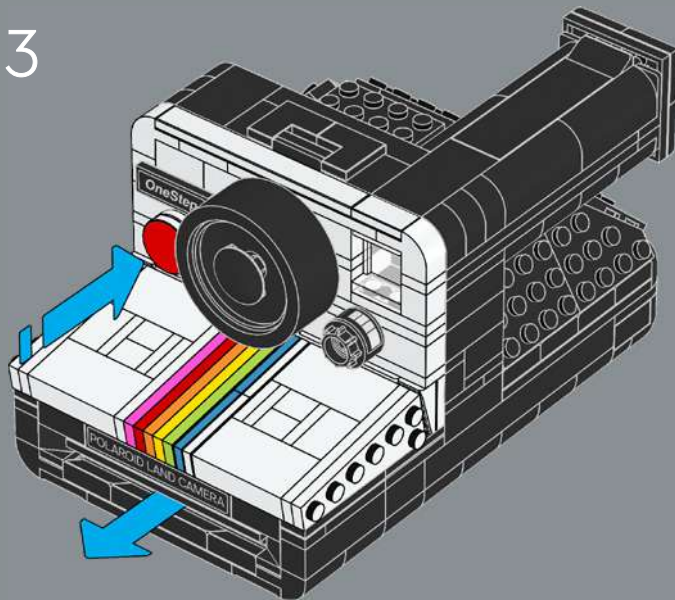



IDEAS

GATHER SUPPORT
HOL DIR UNTERSTÜTZUNG
RECUEILLES DES VOTES
CHIEDI DI ESSERE SUPPORTATO
CONSIGUE APOYOS
OBTÉM APOIO
争取支持
ZDOBĄDŹ GŁOSY

ZÍŠKEJTE PODPORU
ZÍŠKAJTE PODPORU
SZEREZZ TÁMOGATÁST!
CERE SPRIJIN
ПОЛУЧЕТЕ ПОДКРЕПА
IEGŪSTI ATBALSTU
KOGU TOETUST
RINK PALAIKYMĄ

SHARE YOUR IDEA
TEILE DEINE IDEE
PARTAGEZ VOTRE IDÉE
CONDIVIDI LA TUA IDEA
COMPARTE TU IDEA
PARTILHA A TUA IDEIA
分享创意
PODZIEL SIĘ POMYSŁEM
SDÍLEJTE SVÉ NÁPADY

ZDIELAJTE SVOJE NÁPADY
OSZD MEG AZ ÖTLETED!
ÎMPĂRȚĂȘEȘTE IDEEA TA
СПОДЕЛЕТЕ ИДЕИТЕ СИ
PARĀDI SAVU IDEJU
JAGA OMA IDEED
PASIDALINK SAVO IDĖJA

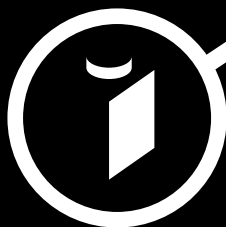

LEGO® REVIEW
LEGO® PRŮFUNG
EXAMEN PAR LEGO®
REVIEW LEGO®
REVISIÓN DE LEGO®
AVALIAÇÃO LEGO®
乐高®审核
OCENA LEGO®

OUZENÍ DESIGNÉRY LEGO®
POSÚDENÉ DIZAJNÉRMÍ LEGO®
LEGO® VÉLEMÉNYEZÉS
VERIFICARE LEGO®
ПРЕГЛЯД НА LEGO®
LEGO® RECENZJA
LEGO® ARVUSTUS
LEGO® APŽVALGA

NEW LEGO® PRODUCT
NEUES LEGO® PRODUKT
NOUVEAU PRODUIT LEGO®
NUOVO PRODOTTO LEGO®
NUEVO PRODUCTO LEGO®
NOVO PRODUTO LEGO®
全新乐高®产品
NOWY PRODUKT LEGO®

NOVÁ STAVEBNICE LEGO®
NOVÁ STAVEBNICA LEGO®
ÚJ LEGO® TERMÉK
PRODUS LEGO® NOU
НОВ ПРОДУКТ LEGO®
JAUNS LEGO® PRODUKTS
UUS LEGO® TOODE
NAUJAS LEGO® PRODUKTAS

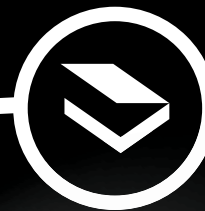

ideas.LEGO.com

4x
300501

4x
302401

2x
6170567

2x
4544140

2x
6392747

2x
6210272

2x
6392746

1x
6464145

1x
614301

6x
300401

1x
6146215

9x
302301

120

2x
306901

2x
6023804

4x
6153776

2x
6346616

1x
235701

2x
6366391

1x
6289797

2x
362301

2x
6223491

2x
6061047

1x
365901

1x
4560178

1x
300101

2x
6285777

5x
366601

1x
6400128

2x
416201

1x
300801

1x
6464144

5x
447701

3x
611101

3x
383201

3x
4528341



1x
6468167



1x
6468166



1x
6468168

1x
4565452

3x
6271820

2x
6378120

2x
4142865

1x
4179355

3x
6092565

2x
4612575

1x
6078641

1x
6129995

1x
370121

1x
303721

1x
6371582

1x
366621

1x
4181138

2x
346021

1x
611121

1x
4624985

1x
6208753

4x
235724

3x
374724

1x
243124

1x
663624

1x
366624

2x
303424

10x
302426

2x
407026

2x
654126

2x
6436425

2x
300526

2x
307026

2x
4504382

1x
4106347

2x
6335317

2x
6299338

2x
6380236

2x
6320309

3x
6210270

2x
4180536

1x
4180508

13x
4548180

7x
6279875

4x
4278359

1x
6291069

1x
4198367

7x
306926

3x
302326

1x
6138173

3x
300426

1x
6146220

8x
6184784

1x
366526

2x
6174243

2x
6266244

1x
6000650

4x
6020193

2x
4225201

2x
4283046

26x
6458098

1x
235726

1x
6425507

5x
6192346

2x
6133722

4x
6370961

1x
302226

2x
6061032

2x
242026

2x
6430580

2x
6359039

4x
4558170

9x
362326

5x
362226

1x
4227684

2x
6448733

7x
302126

1x
6162892

2x
4162443

2x
371026

1x
4530589

4x
301026

2x
6092570

2x
243126

4x
4160025

1x
396026

4x
6174917

3x
4560182

2x
302026

1x
300126

4x
6174252

4x
6256116

1x
6459287

2x
366626

2x
663626

1x
300926

1x
6058118

2x
4243819

Polaroid

1x
6464143

2x
6318582

1x
379526

5x
416226

3x
346026

2x
303226

8x
303426

2x
4645732

5x
447726

2x
611126

2x
383226

1x
4514845

1x
244526

1x
302826

1x
6253231

2x
6223454

1x
6173129

1x
6021787

1x
6147047

1x
6271832

1x
4160593

1x
4118827

1x
4650690

1x
4173332

1x
6240515

4x
4212454

1x
6138661



1x
4166093

2x
6327442

1x
4164021

1x
6454585

1x
6167465

3x
4529160

1x
6381913

1x
4211406

4x
4211462

3x
4211525

4x
6448793

2x
4211535

2x
6335378

3x
4211807

1x
6462467

1x
4211414

2x
6266209

1x
4211398

2x
6446028

2x
4211429

5x
4211445

4x
4211613

2x
6015347

2x
4560183

4x
6290401

4x
4210633

10x
6344022

1x
4210788

1x
4210782

1x
6350724

5x
6258991

1x
6083620

9x
6057387

1x
6147732

6x
6056263

1x
4649764

1x
6097094

3x
6446031

5x
6004943

1x
6292486

1x
6298471

2x
6459289

1x
6205089

1x
6164336

3x
4640891

1x
6343649

 [LEGO.com/service](https://www.LEGO.com/service)



YOU COULD WIN



YOU COULD WIN

Your feedback will help shape the future development of this product series.

Visit:

DU KÖNNTEST GEWINNEN

Dein Feedback trägt zur Weiterentwicklung dieser Produktreihe bei.

Geh auf:

VOUS POURRIEZ GAGNER

Vos commentaires nous aideront à concevoir les futurs produits de cette gamme.

Visitez :

POTRESTI VINCERE TU

La tua opinione ci aiuterà a migliorare la creazione futura di questa linea di prodotti.

Visita:

PUEDES GANAR

Tu opinión contribuirá al futuro de esta serie de productos.

Visita:

轻松获奖

您的反馈将有助于我们在今后改进本产品系列。

请访问:

LEGO.com/productfeedback

You also have the chance to win a LEGO® set.

Terms and conditions apply.*

Außerdem hast du die Chance, ein LEGO® Set zu gewinnen.

Es gelten die Teilnahmebedingungen.*

Vous pourriez également gagner un ensemble LEGO®.

Des conditions s'appliquent.*

Hai anche la possibilità di vincere un set LEGO®.

Termini e condizioni sono applicabili.*

También tienes la oportunidad de ganar un set LEGO®.

Aplican términos y condiciones.*

您还有机会赢取乐高®套装。

条款和条件适用。*

*LEGO.com/productfeedback-terms

The image features a vertical rainbow spectrum background with six distinct color bands: red, orange, yellow, green, and blue. The word "polaroid" is centered horizontally across the yellow and green bands in a white, lowercase, sans-serif font.

polaroid

LEGO and the LEGO logo are
trademarks of the LEGO Group.
©2024 The LEGO Group. 6494182
POLAROID, SX-70, ONESTEP and
the Polaroid Color Spectrum are
protected trademarks of Polaroid.