



CREATOR™

3 IN 1

31145



3in1	3 w 1
3-in-1	3 v 1
3-en-1	3 az 1-ben
3 in 1	3 ñ 1
3en1	„3 B 1“
3em1	3 ühes
3 合 1	„Trys viename“



Q LEGO® Builder



LEGO.com/sustainable-packaging



FR
DONNEZ
OU
RECYCLEZ

 OU  OU 

ASSOCIATION MAGASIN DÉCHÈTERIE

Adresses sur quefairedemesdechets.fr



Q LEGO® Builder

BUILDER



Apple and the Apple logo are trademarks of Apple Inc., registered in the U.S. and other countries and regions. App Store is a service mark of Apple Inc. Google Play and the Google Play logo are trademarks of Google LLC. Tencent and the Tencent logo are trademarks of Tencent Inc.

Q [LEGO.com/devicecheck](https://www.lego.com/devicecheck)

EN Ask parents' permission before going online | **DE** Eltern um Erlaubnis bitten, bevor du online gehst | **FR** Demande l'autorisation d'un parent avant d'aller en ligne | **IT** Chiedi il permesso ai tuoi genitori prima di andare online | **ES** Pídeles permiso a tus papás antes de conectarte a Internet | **PT** Pedir autorização aos pais antes de acederes online | **ZH** 上网前应先征得父母的同意 | **PL** Poproś rodziców o zgodę, zanim wejdiesz do Internetu | **CS** Než půjdeš na internet, požádej rodiče o svolení | **SK** Skôr než pôjdeš na internet, vypýtaj si povolenie od rodičov | **HU** Kérj szülői engedélyt, mielőtt online csatlakoznál! | **RO** Cere permisiunea părinților înainte de a te conecta online | **BG** Поискайте разрешение от родител, преди да влезете онлайн | **LV** Pirms došanās tiešsaistē palūdz atļauju vecākiem | **ET** Enne Interneti kasutamist küsi vanematelt luba | **LT** Prieš prisijungdami prie interneto, atsiklauskite tėvų





1x



1x

1

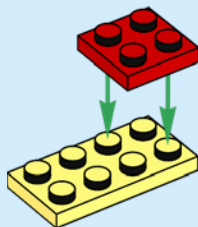



1x



1x

2

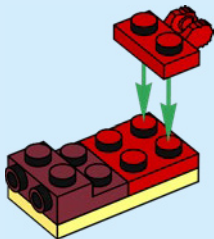

2x

3

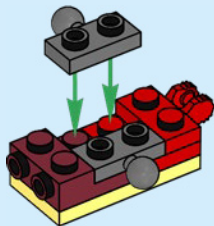



2x

4

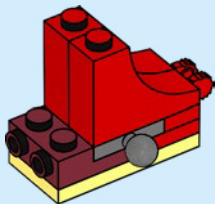

2x

5

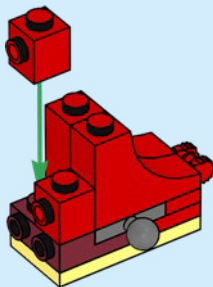



1x

6

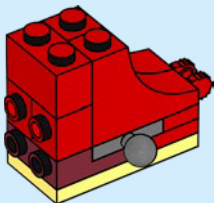

1x

7

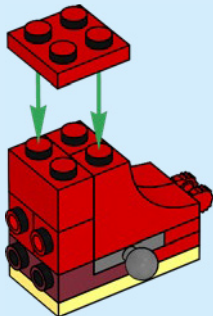



1x

8

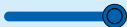
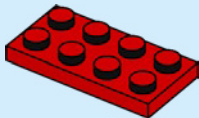



1x

9

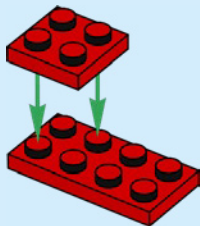

2x

10

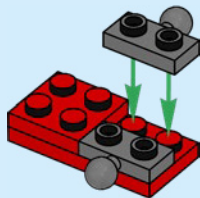



1x

11

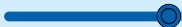
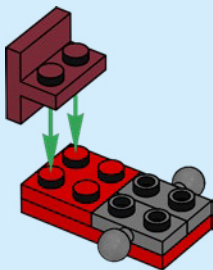



1x



1x

12

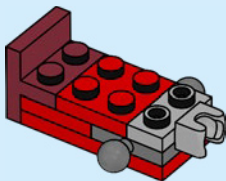

2x



1x

13

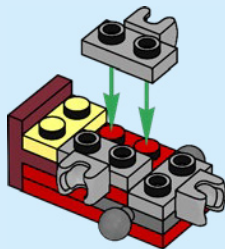



2x

14

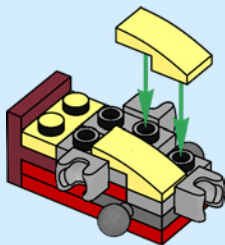



1x

15

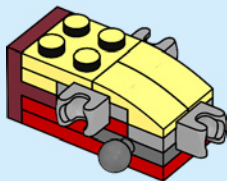

16

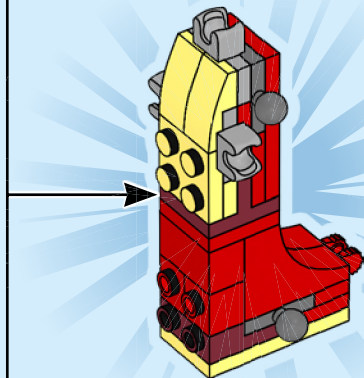



1x



2x

17

1

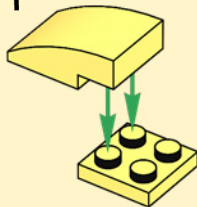

2

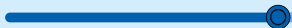
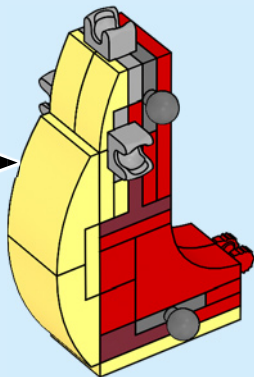
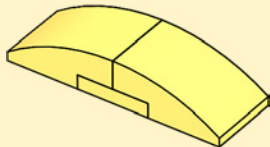

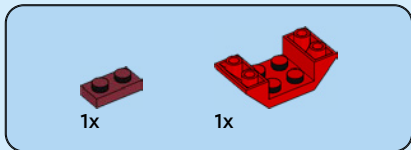
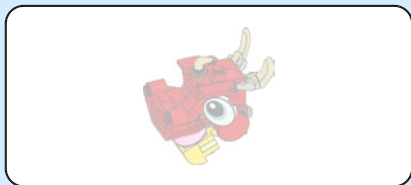

18

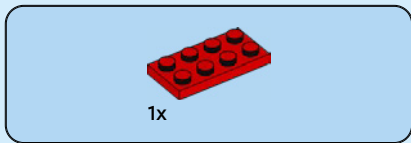
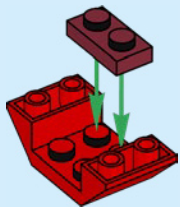

19

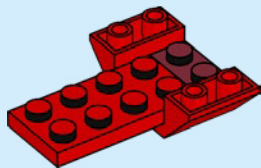



1x



1x

20

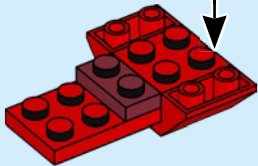
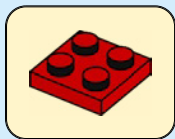



2x

21

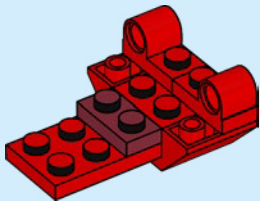

2x

22



2x

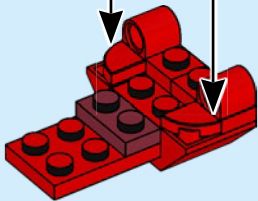



2x

23

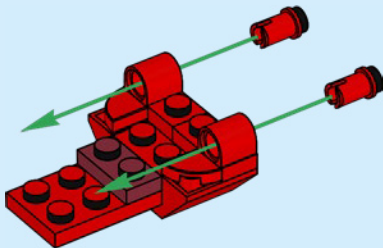



2x

24

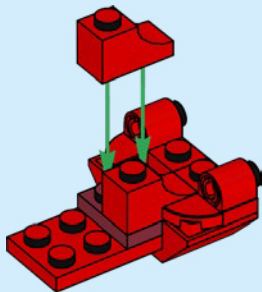

1x

25

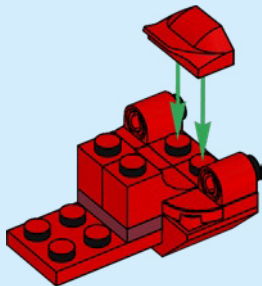



1x



2x



1x

26

1



2



3



4

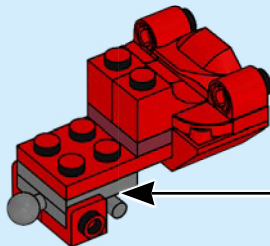
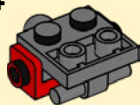



2x

27

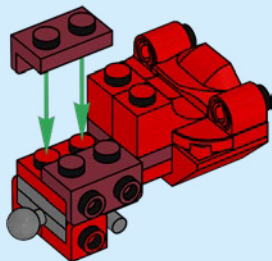

2x

28

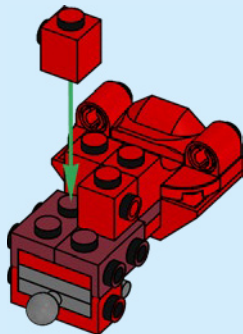



1x

29

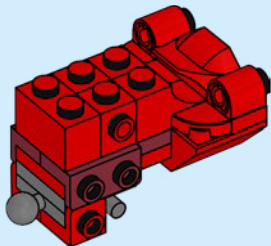

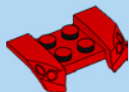

1x



2x

30

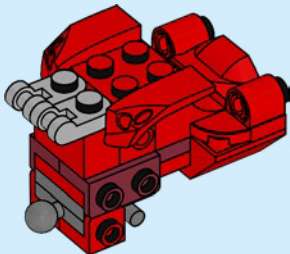

1x



1x

31

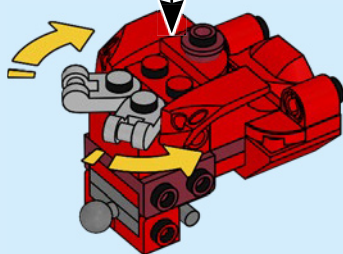
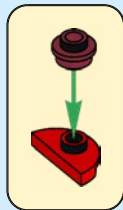



1x

32

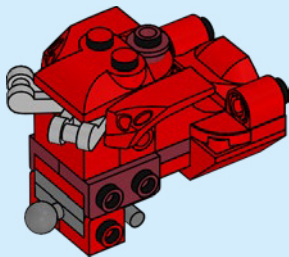



1x

33

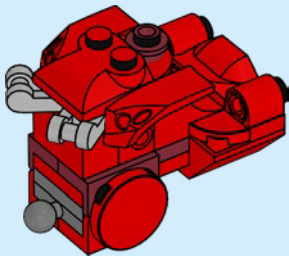

1x



1x

34

1



2

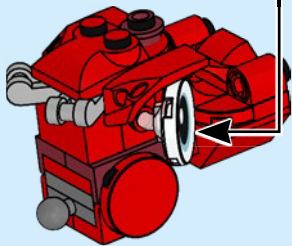



1x

35

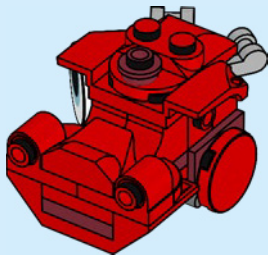

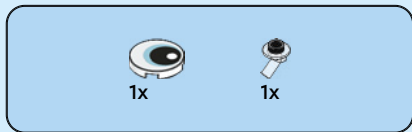

36

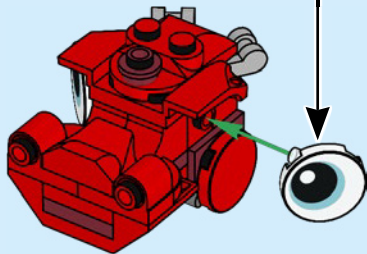



1x



1x



2x



1x

37

1

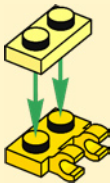

2

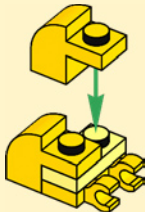

3

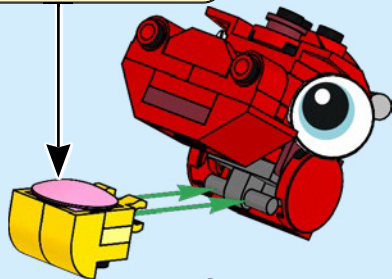
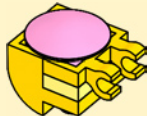

1x

2x

38



39

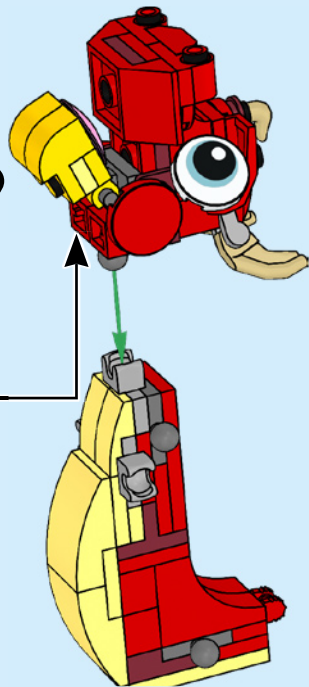



1x

40

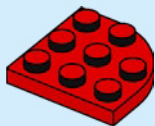



1x

41

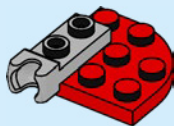

1x

42





1x



1x

43

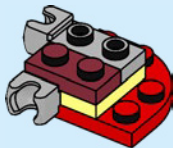



1x

46

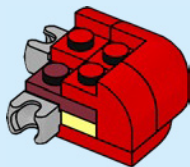



1x

47

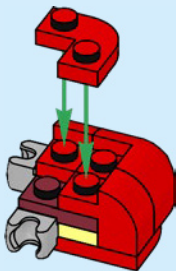

48

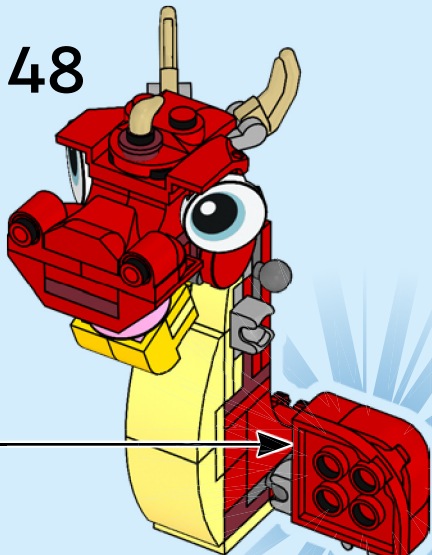



1x

49

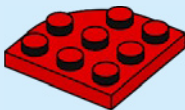



1x

50



1x

51





1x



1x

52

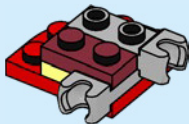



1x

53

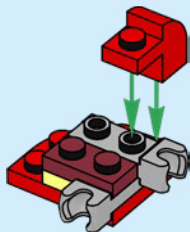

1x



1x

54

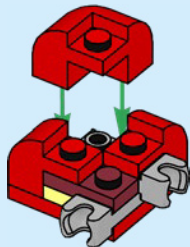



1x

55

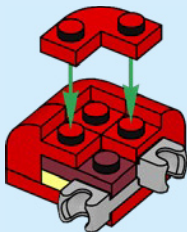

56

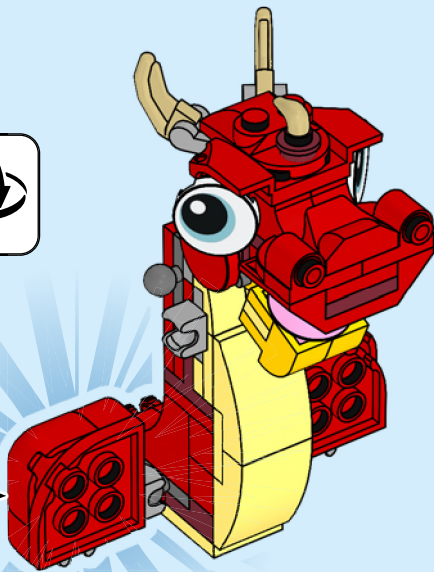
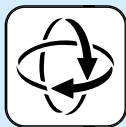



2x



2x



2x



2x



2x



2x



2x

57

1



2

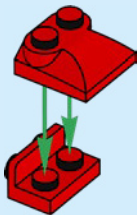

3



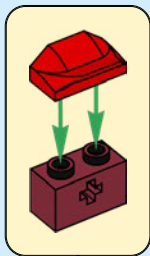

4

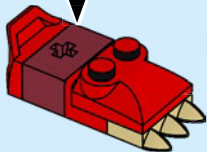

5

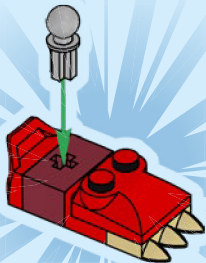

2x

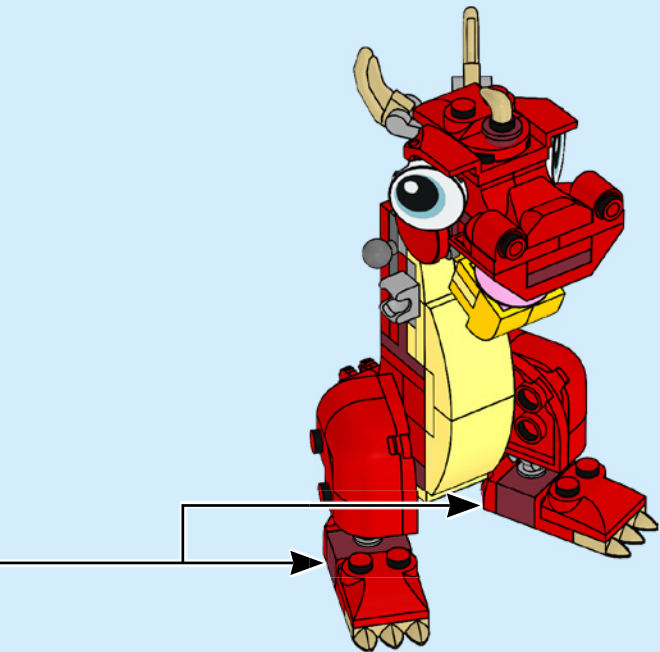

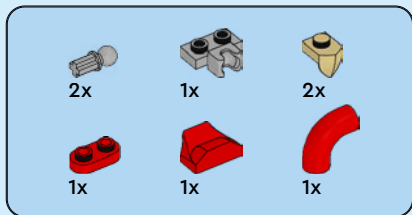

58

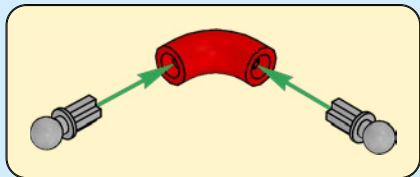

1

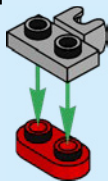

2



3



4

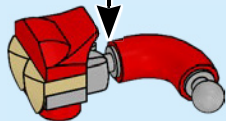

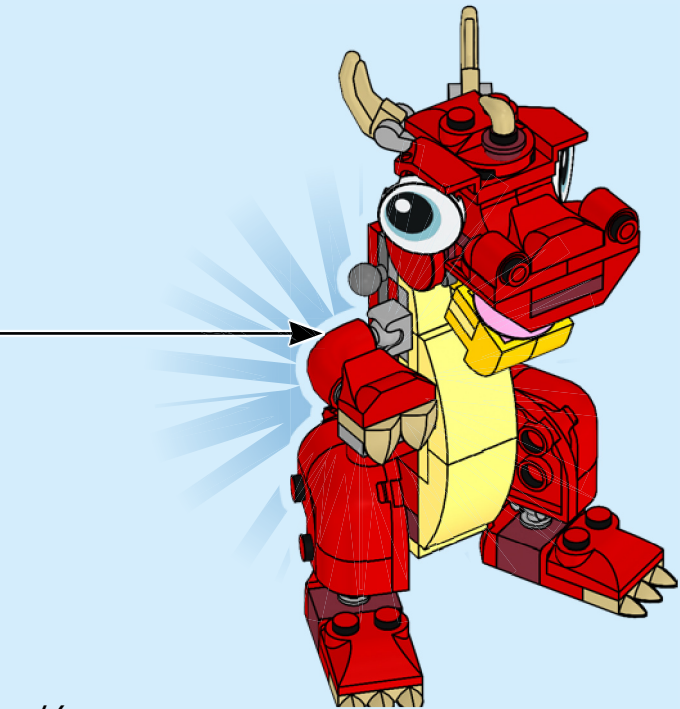



1x



1x

59

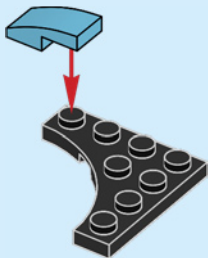

1x



1x

60

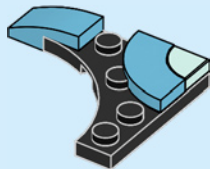



3x

61

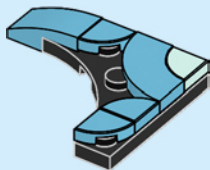



1x

62

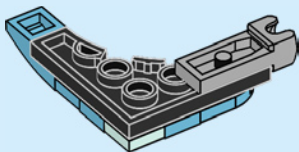
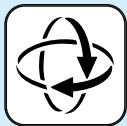

1x

63

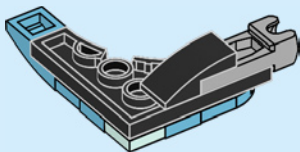

64

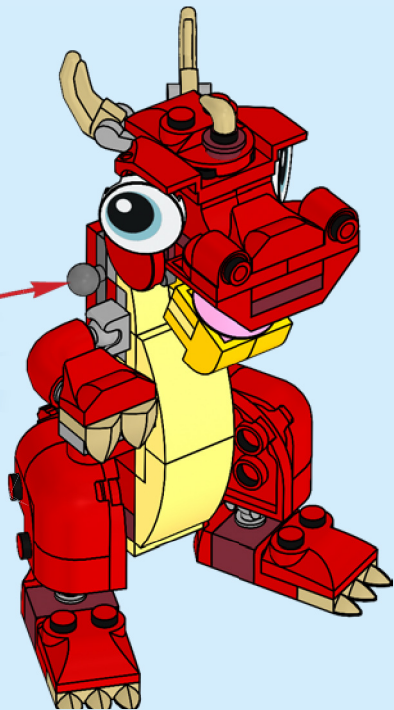
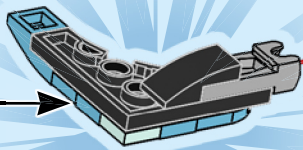

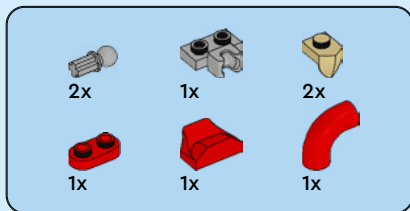

65

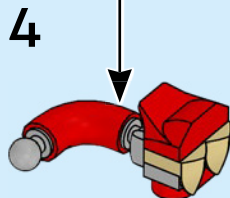
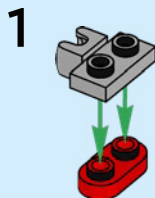
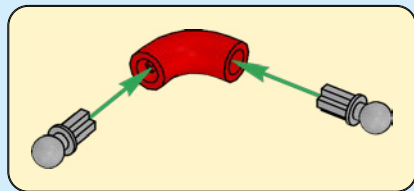

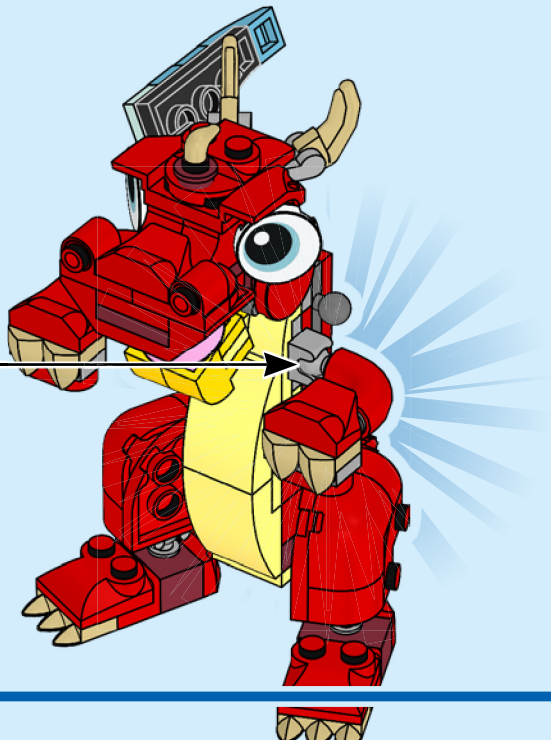

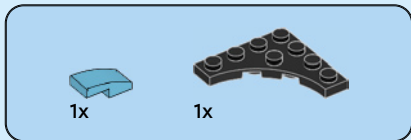
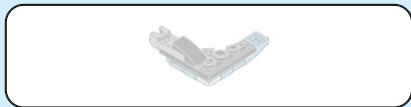

66

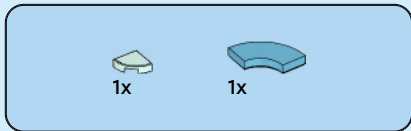
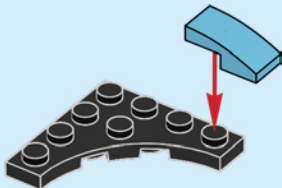

67

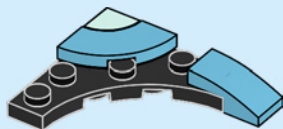



3x

68

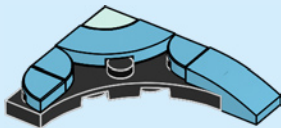



1x

69

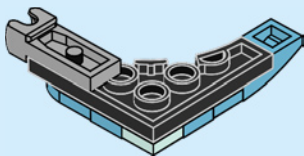



1x

70

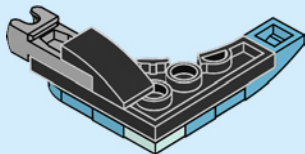

71

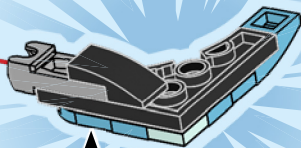
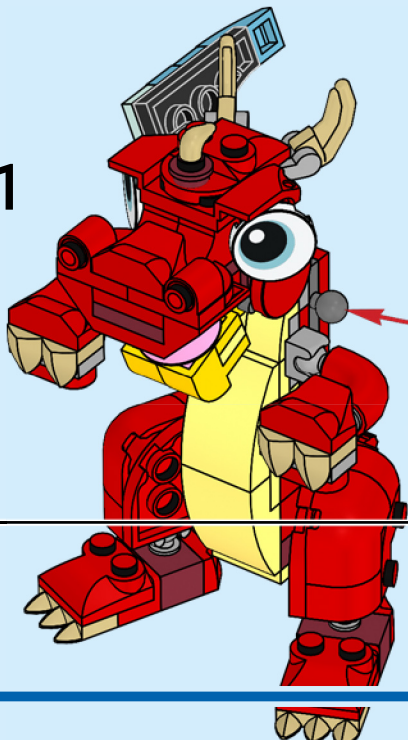

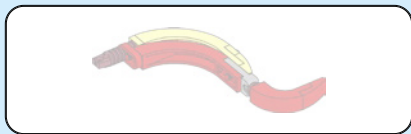

1x

1x

72



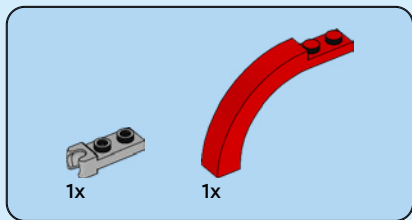

73

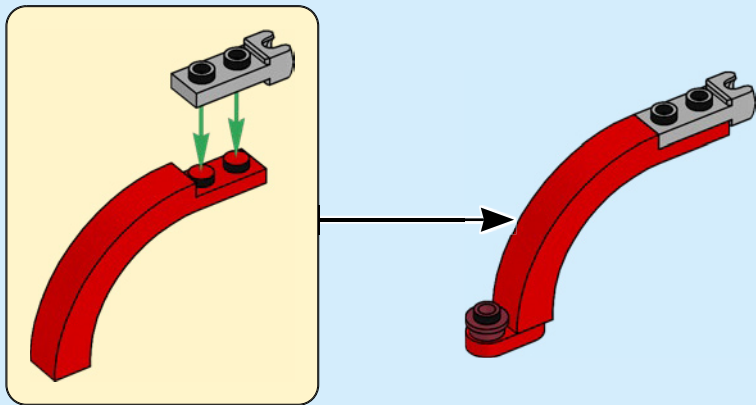

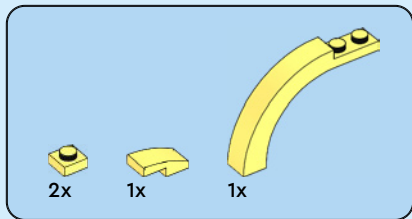

74

1

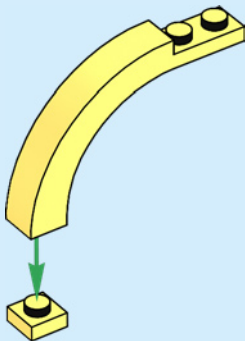

2

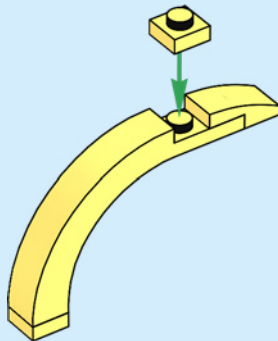

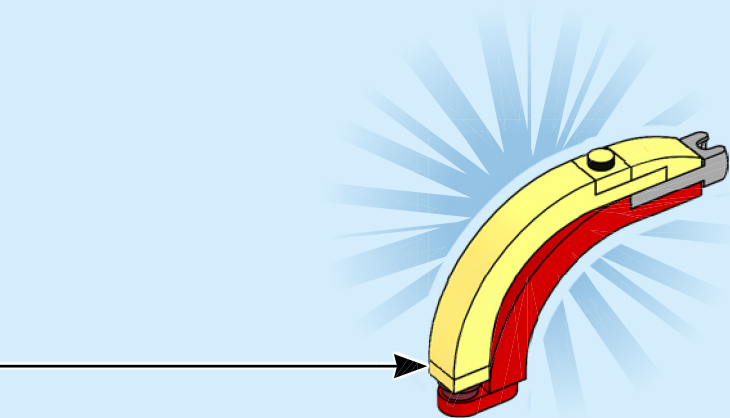



1x



1x

75

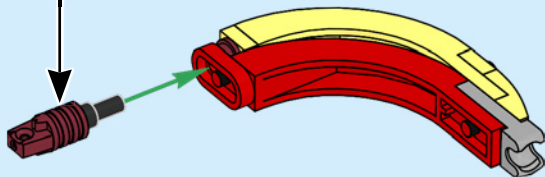
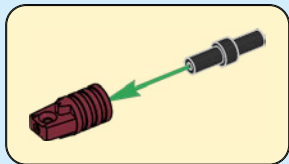

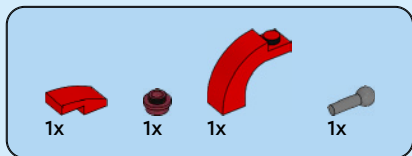

76

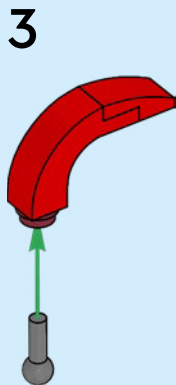
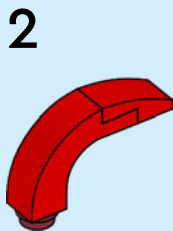
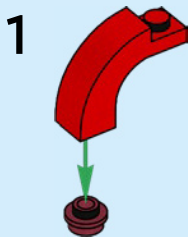

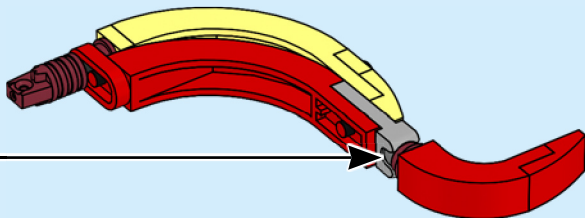

77







CREATOR™

3 IN 1

31152



31150



31146



31149

31147



31145



31148



SHARE YOUR FEEDBACK



Scan this QR code or go to
LEGO.COM/PRODUCTFEEDBACK and give us
your short feedback about this LEGO® set.

Terms and Conditions apply*

EN: SHARE YOUR FEEDBACK. Terms and Conditions apply* **DE: Teile dein FEEDBACK.** Es gelten die Teilnahmebedingungen* **FR: Partagez vos COMMENTAIRES.** Des conditions s'appliquent* **IT: Condividi il tuo FEEDBACK.** Termini e condizioni sono applicabili* **ES: Comparte tu OPINIÓN.** Aplican términos y condiciones* **PT: Partilha o teu FEEDBACK.** Aplicam-se termos e condições* **ZH: 请分享您的反馈. 条款和条件适用*** **PL: Podziel się swoją OPINIĄ.** Obowiązują warunki korzystania* **CS: Podělte se o ZPĚTNOU VAZBU.** Platí všeobecné smluvní podmínky* **SK: Podel' sa o svoj NÁZOR.** Platia všeobecné zmluvné podmienky* **HU: Oszd meg a VÉLEMÉNYED.** Felhasználási feltételek érvényesek* **RO: Trimite FEEDBACK.** Se aplică termenii și condiții* **BG: Споделете вашите ОТЗИВИ.** Има определени правила и условия* **LV: Sniedziet ATSAUKSMES.** Ir spēkā noteikumi un nosacījumi.* **ET: Jaga oma TAGASISIDET.** Kehtivad tingimused* **LT: Palikite ATSILIEPIMĄ.** Taikomos sąlygos*

*[LEGO.com/productfeedback-terms](https://www.lego.com/productfeedback-terms)

LEGO and the LEGO logo are trademarks of the LEGO Group. ©2024 The LEGO Group.

6494912