



DREAMZZZ

71475





Q LEGO® Builder



LEGO.com/sustainable-packaging



FR
DONNEZ
OU
RECYCLEZ

 OU  OU 

ASSOCIATION MAGASIN DÉCHÈTERIE

Adresses sur quefairedemesdechets.fr

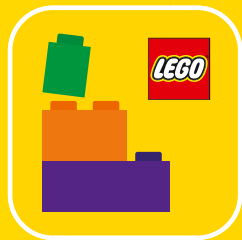

Q LEGO® Builder

BUILDER



Apple and the Apple logo are trademarks of Apple Inc., registered in the U.S. and other countries and regions. App Store is a service mark of Apple Inc. Google Play and the Google Play logo are trademarks of Google LLC. Tencent and the Tencent logo are trademarks of Tencent Inc.

Q LEGO.com/devicecheck

EN Ask parents' permission before going online | **DE** Eltern um Erlaubnis bitten, bevor du online gehst | **FR** Demande l'autorisation d'un parent avant d'aller en ligne | **IT** Chiedi il permesso ai tuoi genitori prima di andare online | **ES** Pídeles permiso a tus papás antes de conectarte a Internet | **PT** Pede autorização aos pais antes de acederes online | **ZH** 上网前应先征得父母的同意 | **PL** Poproś rodziców o zgodę, zanim wejdiesz do Internetu | **CS** Než půjdeš na internet, požádej rodiče o svolení | **SK** Skôr než pôjdeš na internet, vypýtaj si povolenie od rodičov | **HU** Kérj szülői engedélyt, mielőtt online csatlakoznál! | **RO** Cere permisiunea părinților înainte de a te conecta online | **BG** Поискайте разрешение от родител, преди да влезете онлайн | **LV** Pirms došanās tiešsaistē palūdz atļauju vecākiem | **ET** Enne Interneti kasutamist küsi vanematelt luba | **LT** Prieš prisijungdami prie interneto, atsiklauskite tėvų





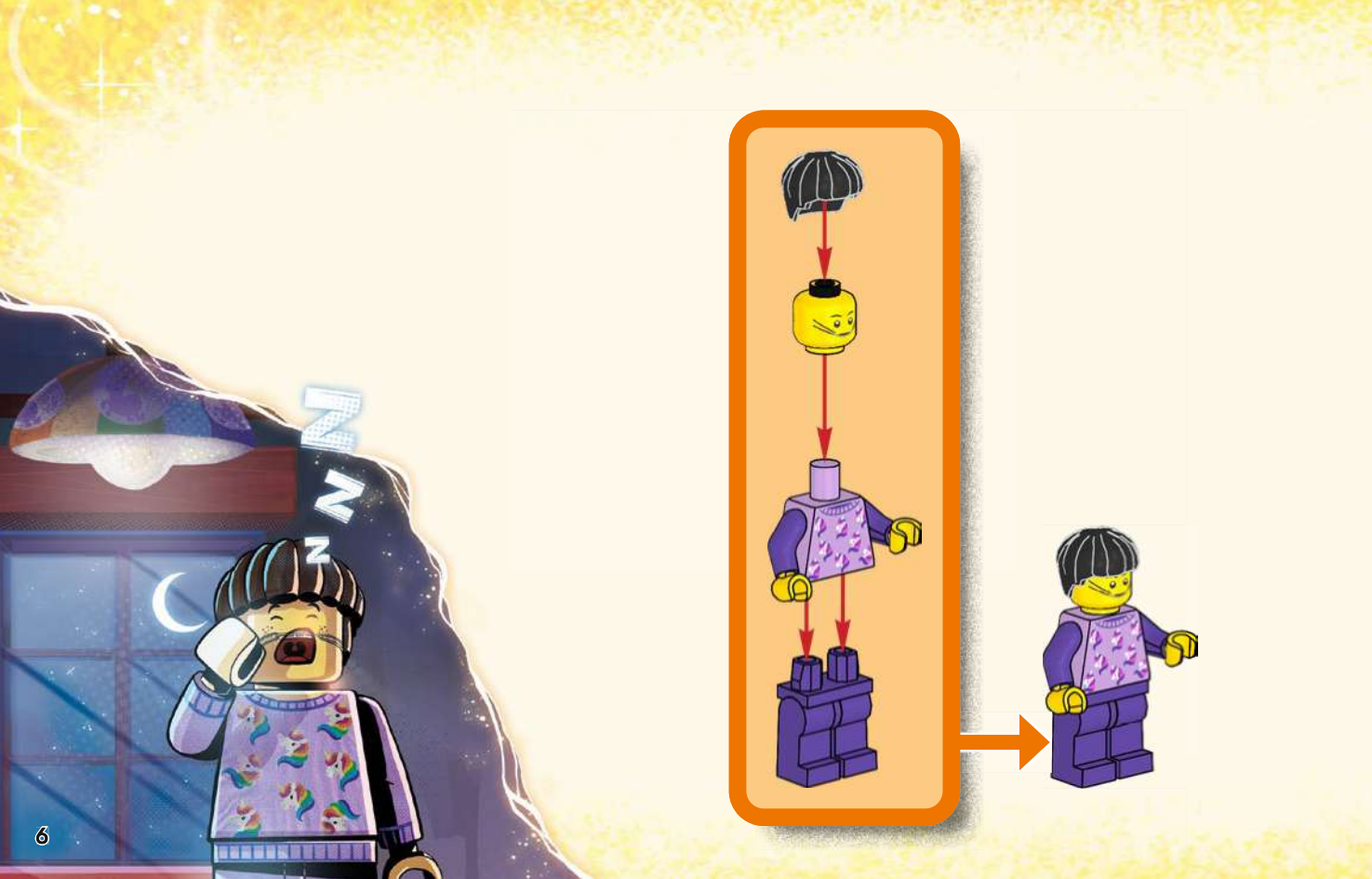





1x



1x

1



2x

2

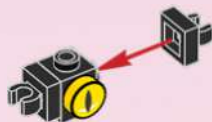

1x

3





4

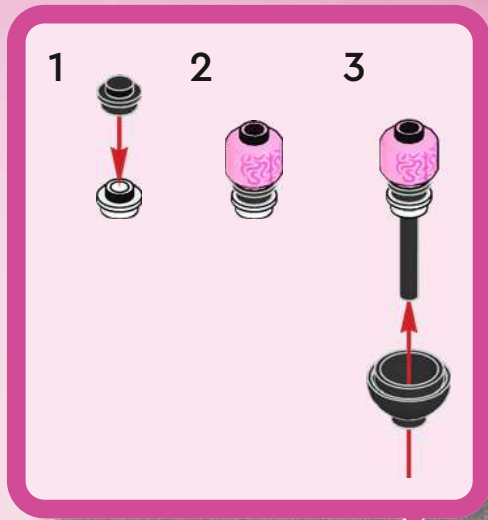



1x

5



2x

6



4x



4x

7

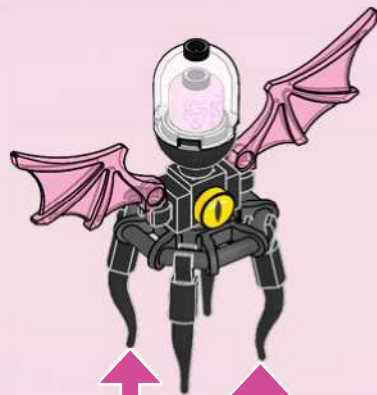

4x





1x



1x

1

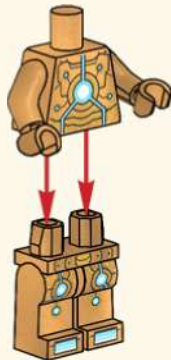



2

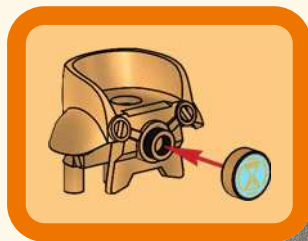



1x



1x

3

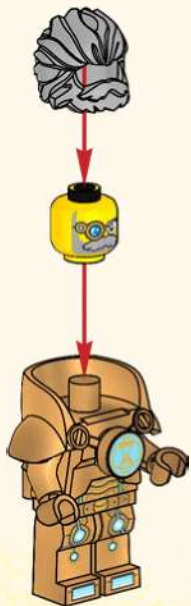

1x



1x

4





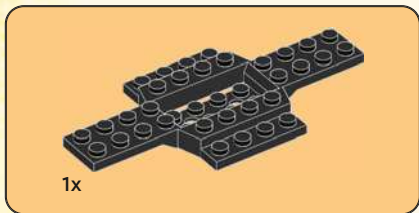
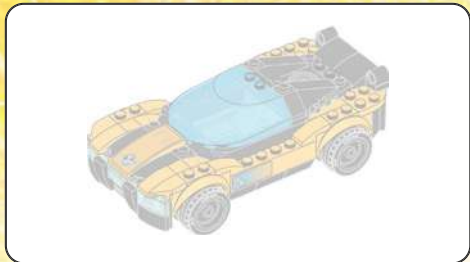

1

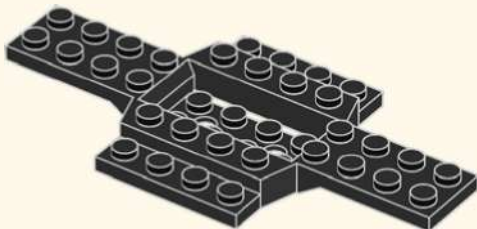

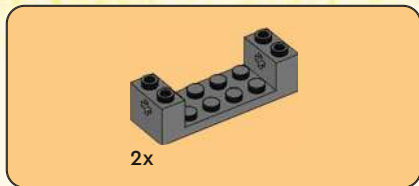

2

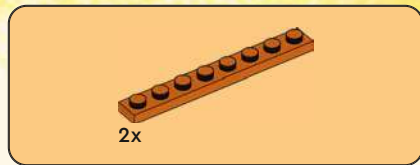
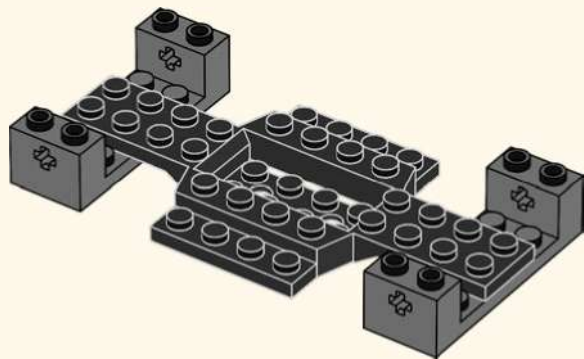

3

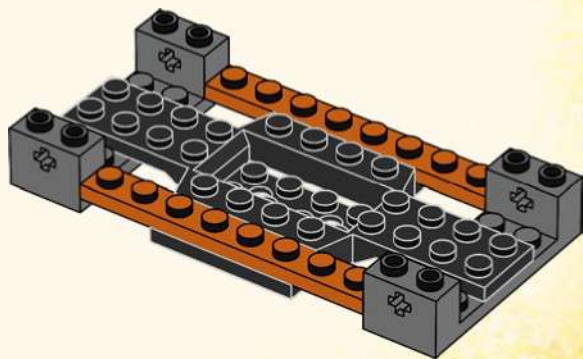



2x

4

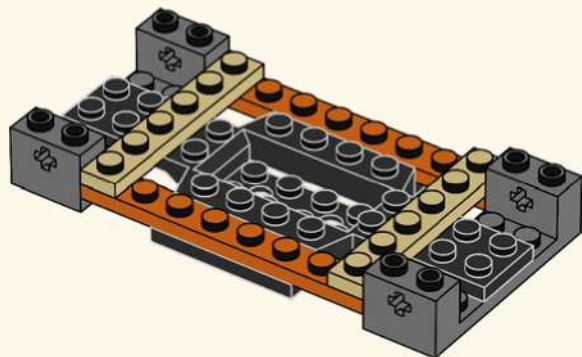

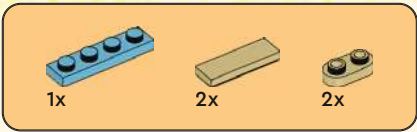

5

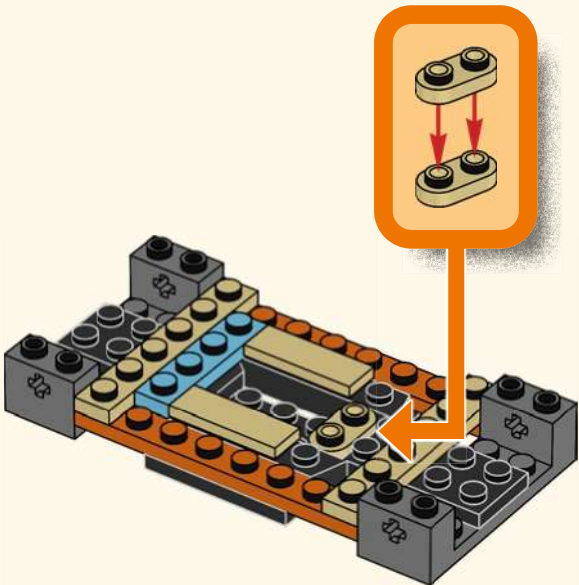

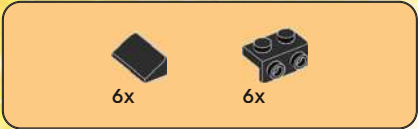

6

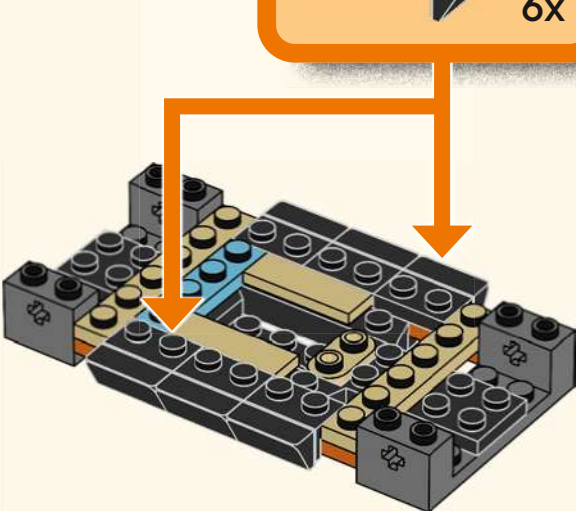
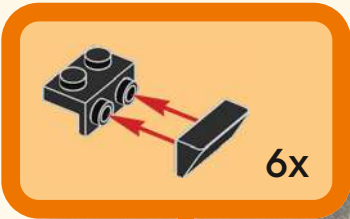

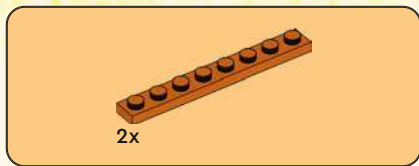

7

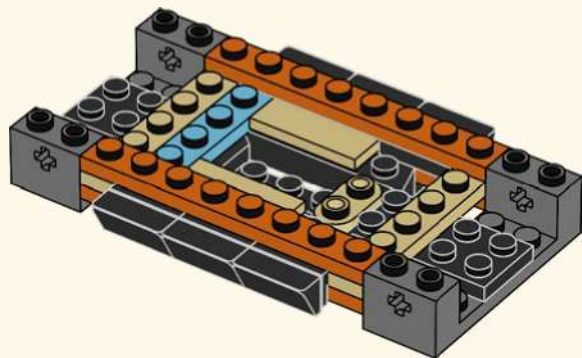

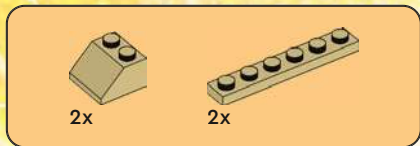

8

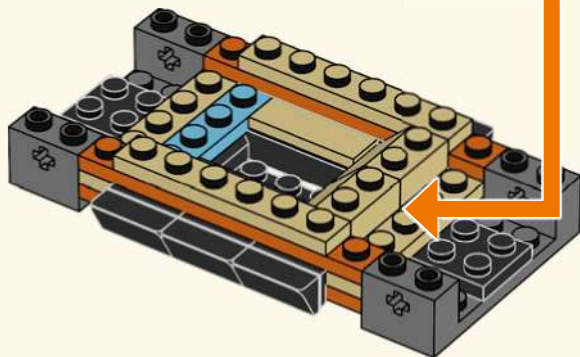
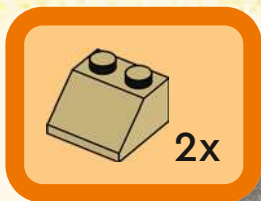

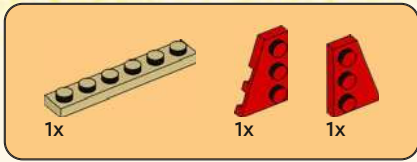

9

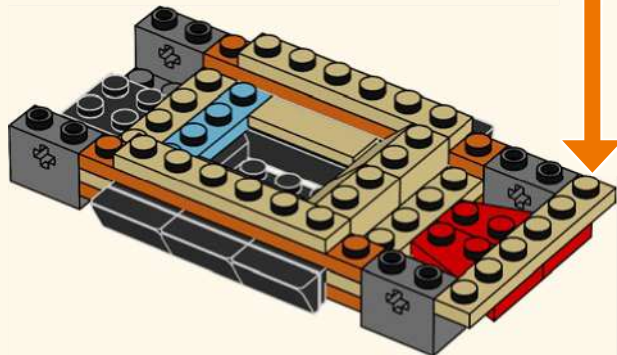
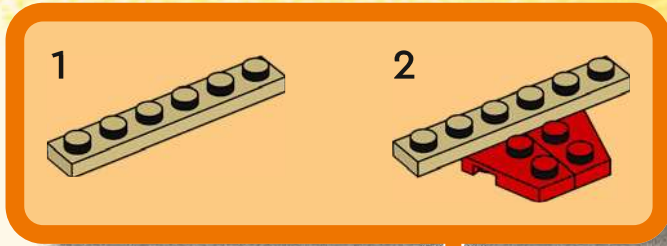



2x

10

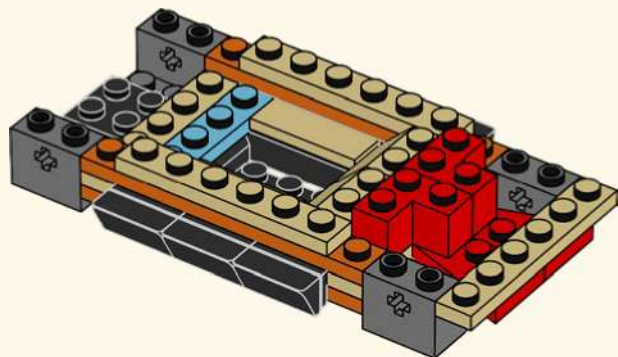



2x

11

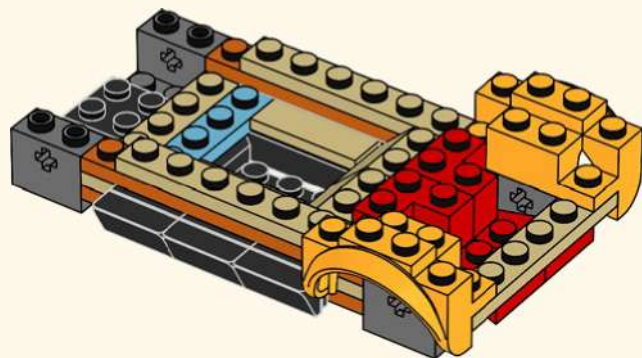

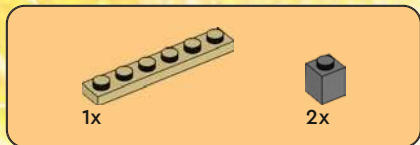

12

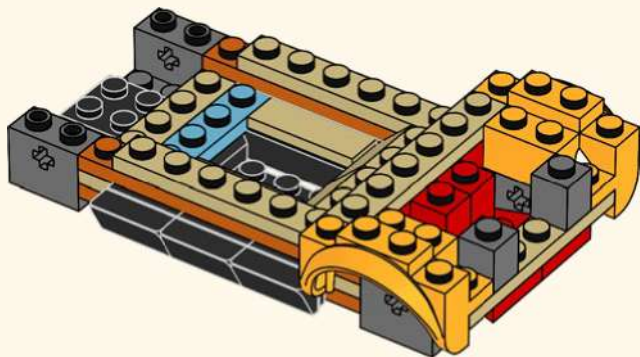

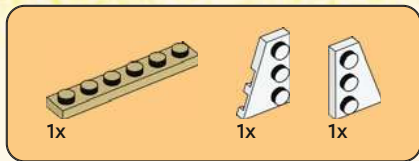

13

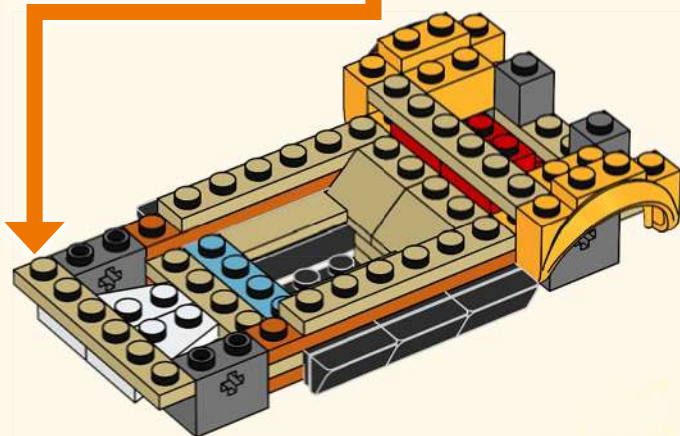
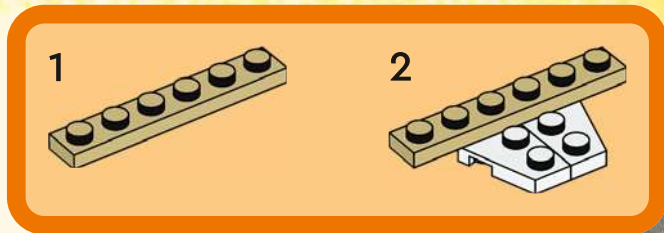



2x



1x

14

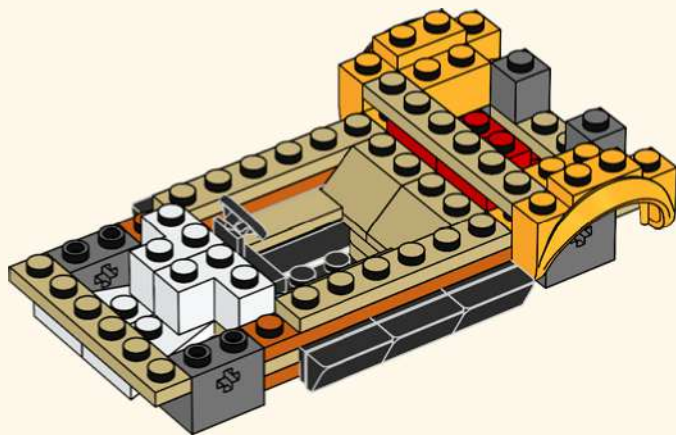



2x

15

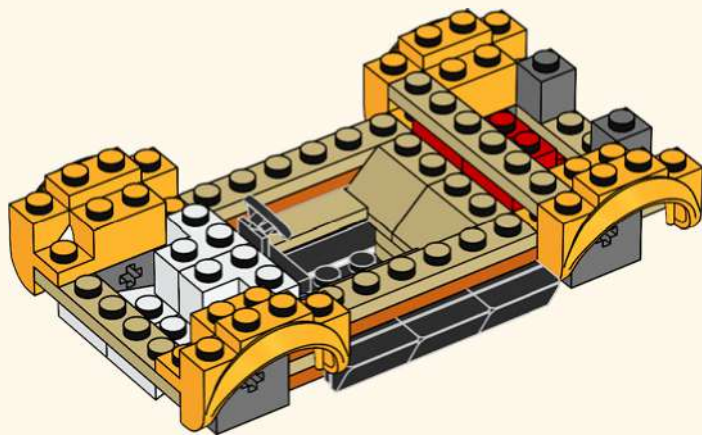

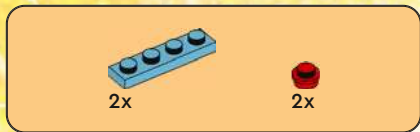

16

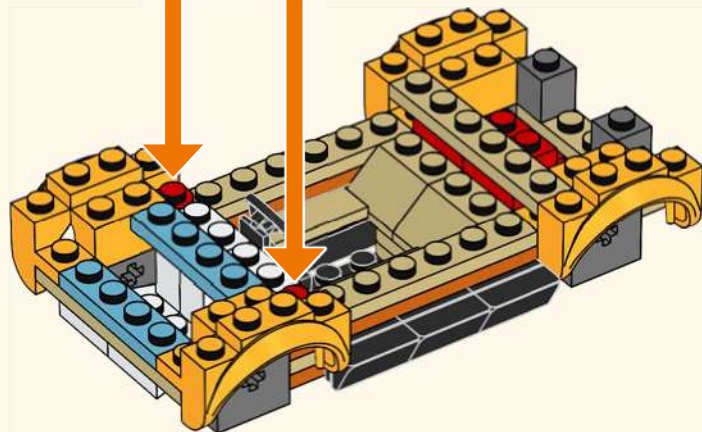

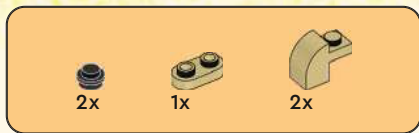

17

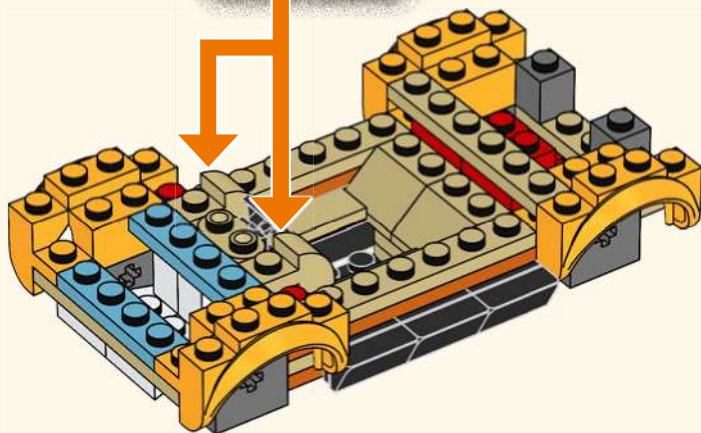
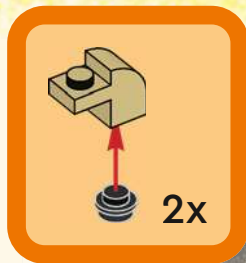

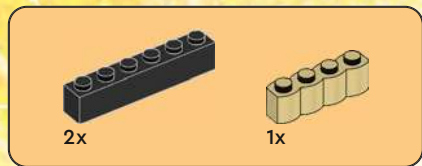

18

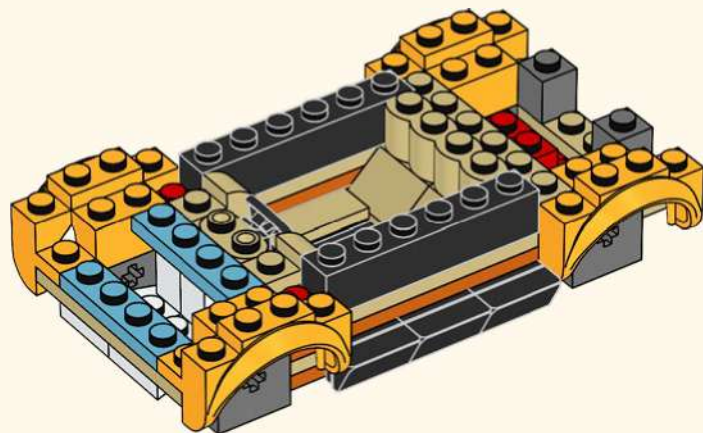



2x

19

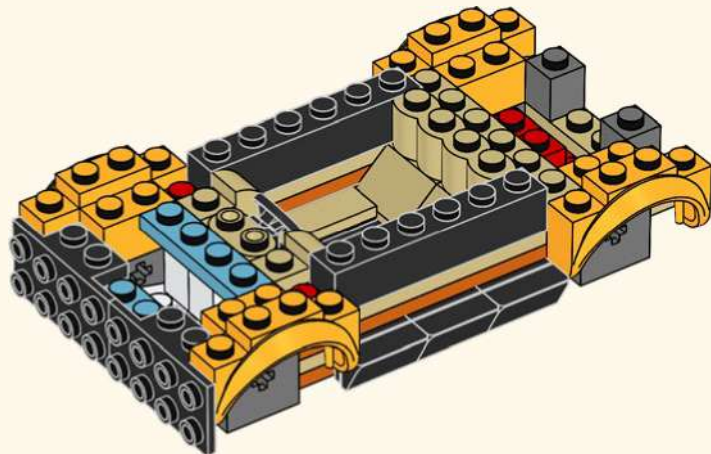



1x



1x



2x



2x

20

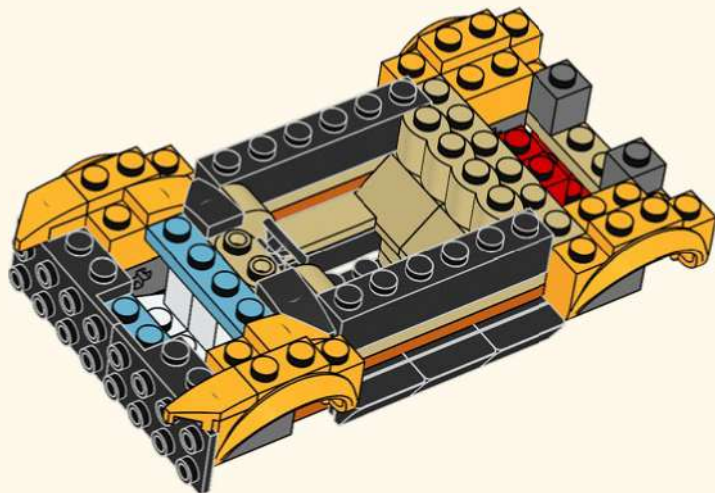





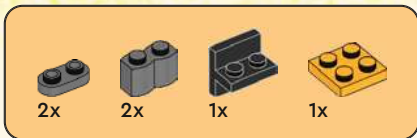

21

1

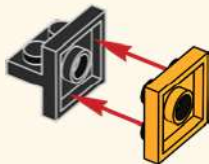

2

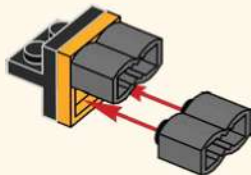

3

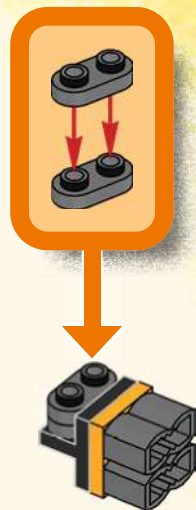

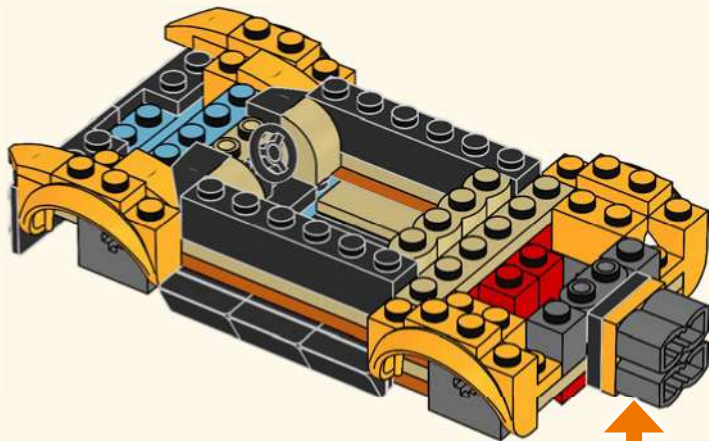

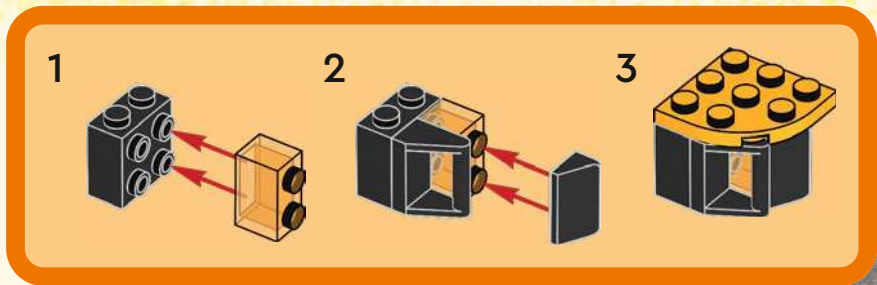

23

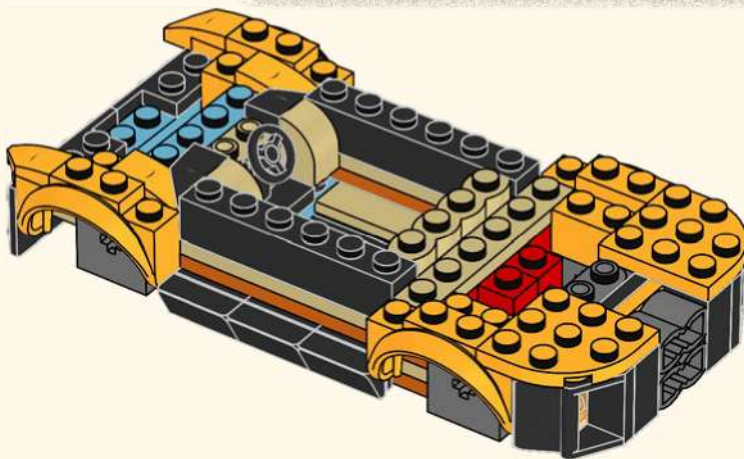



2x

24

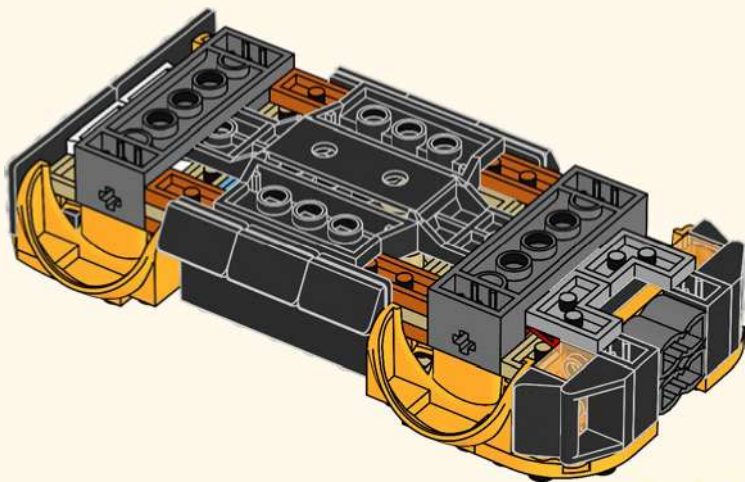



2x

25

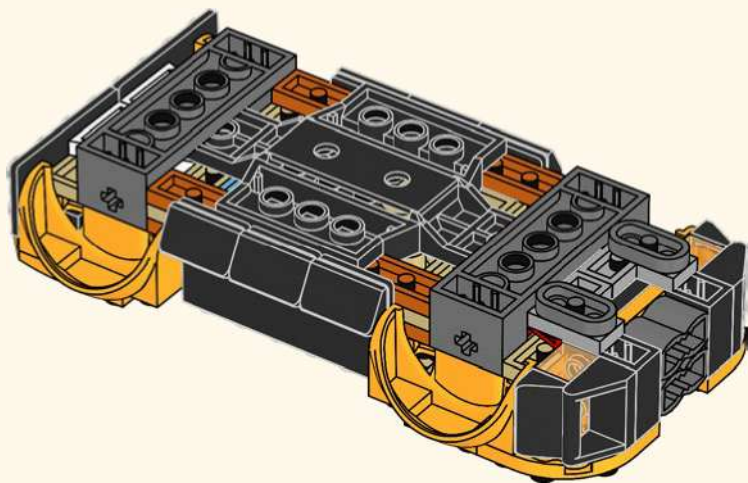



2x

26

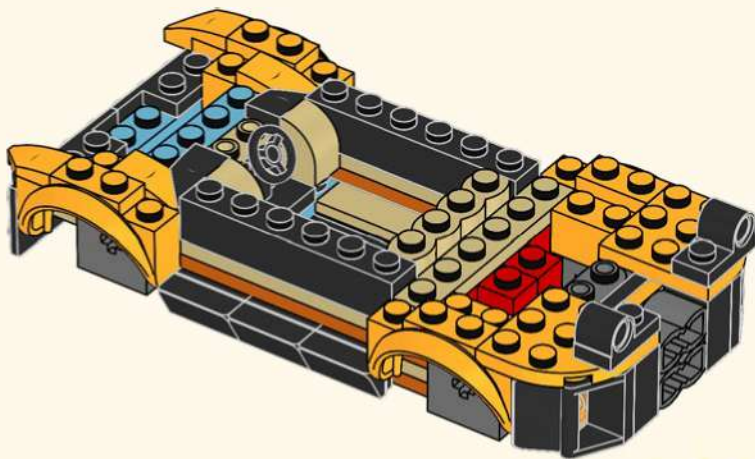



27

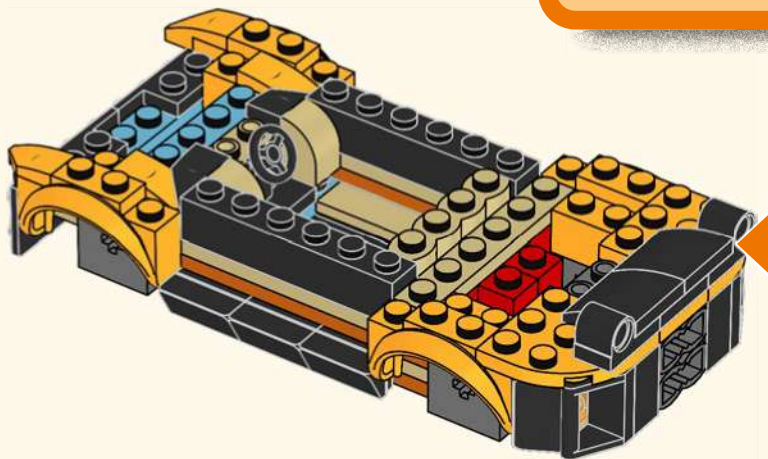
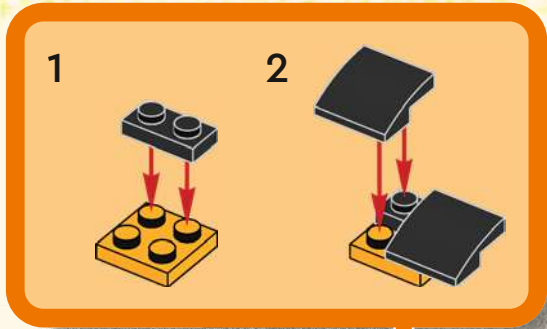



1x



2x

28

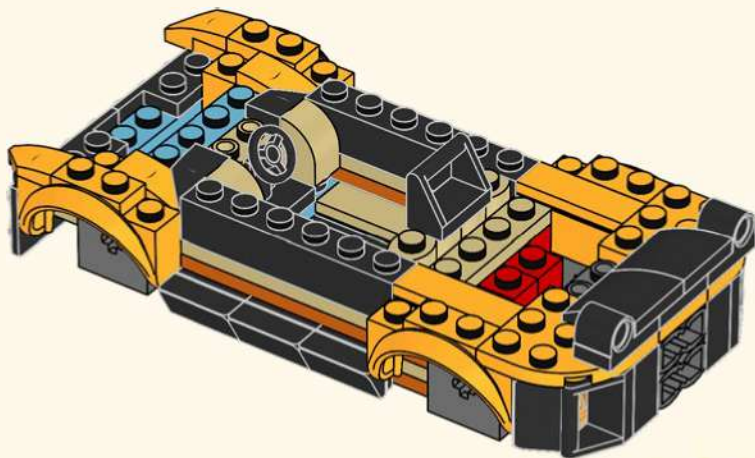

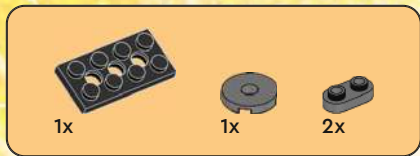

29

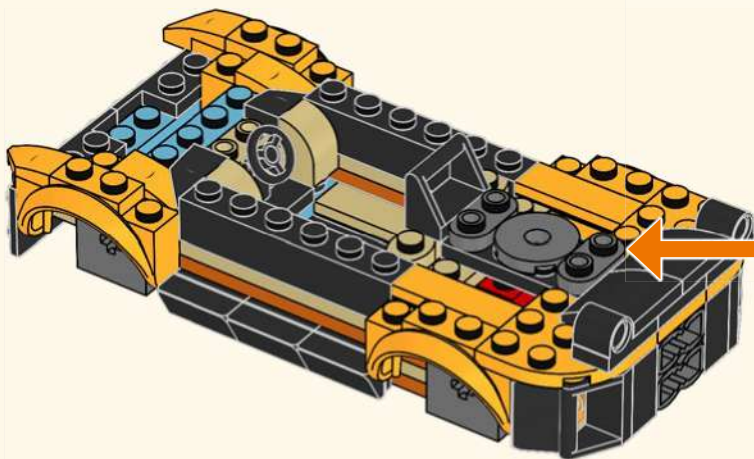
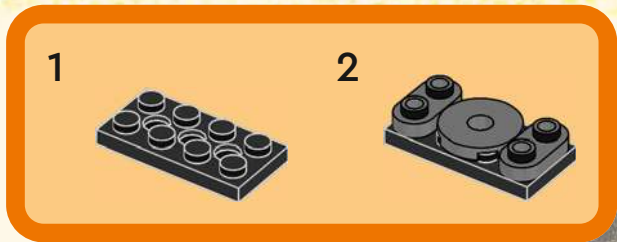

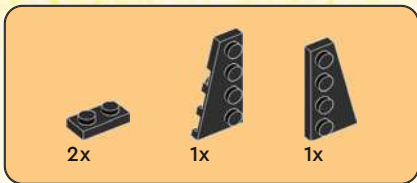

30

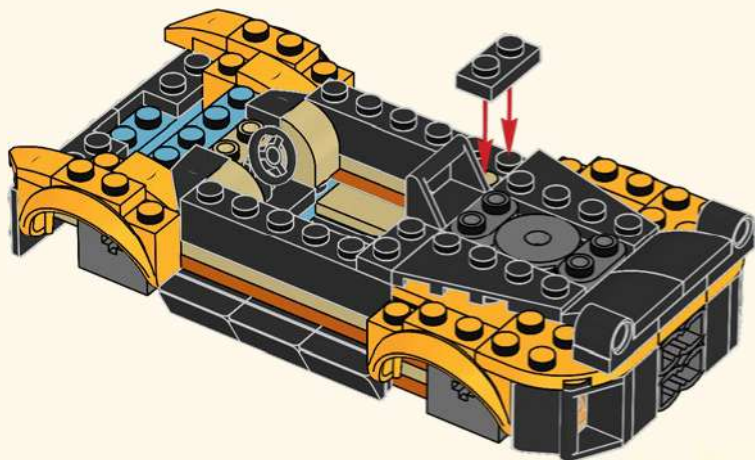

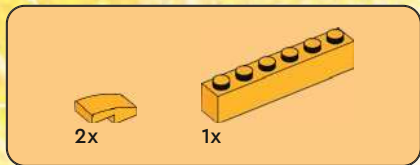

31

1

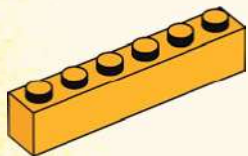

2

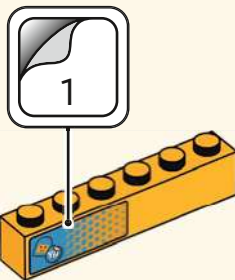

3

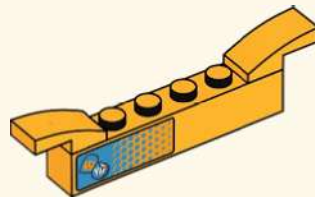

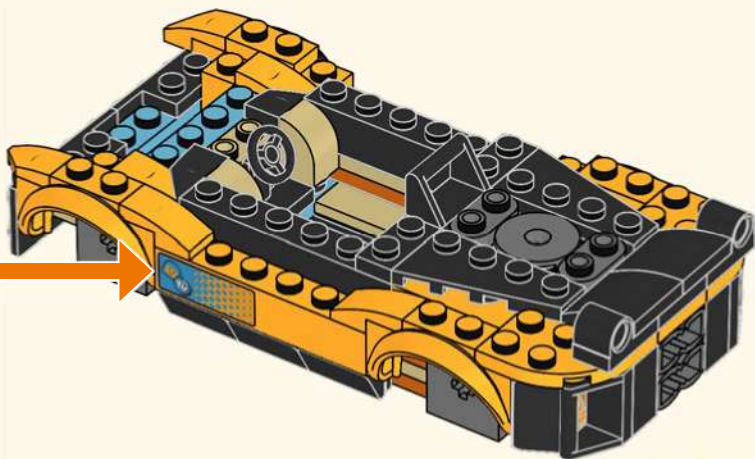

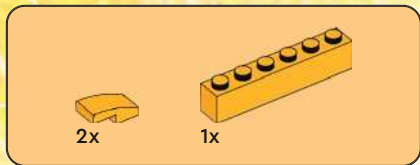

32

1

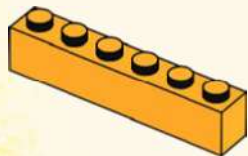

2

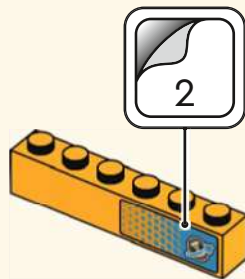

3

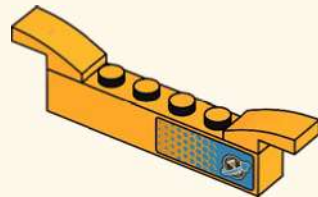

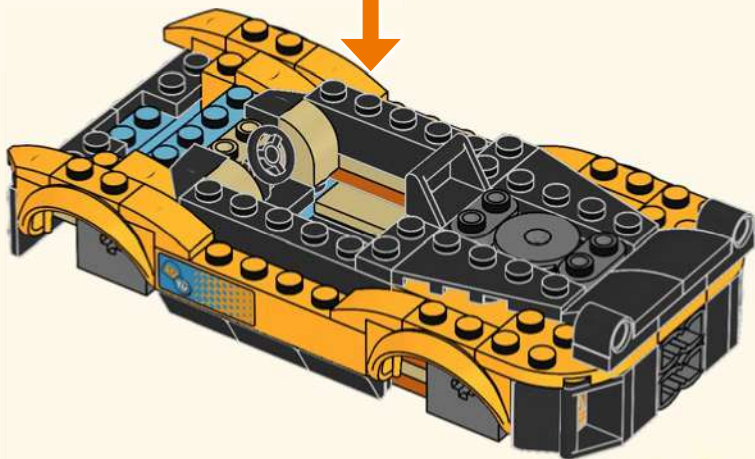



1x



1x

33

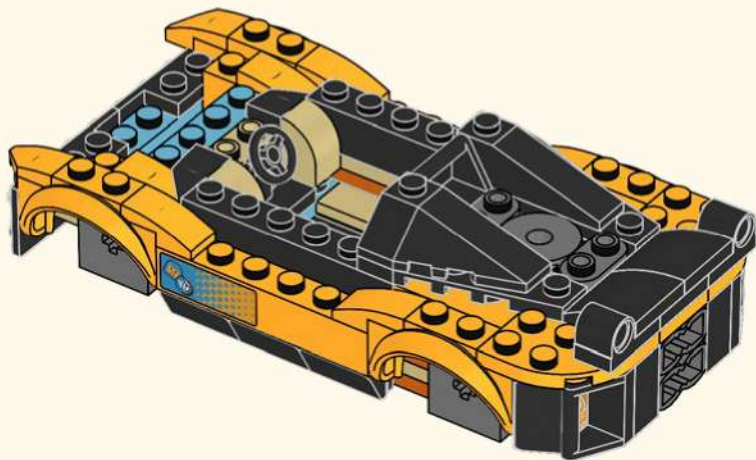



1x

34

1

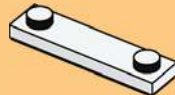

2

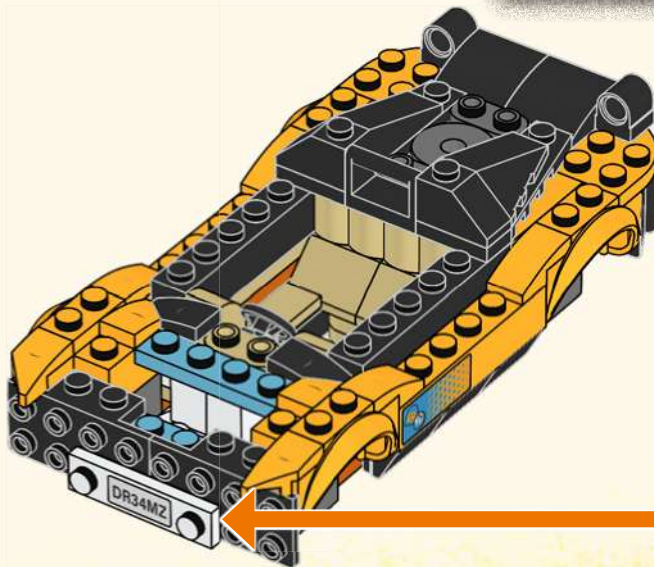
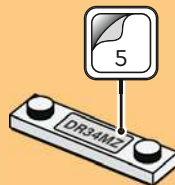

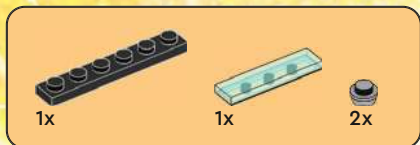

35

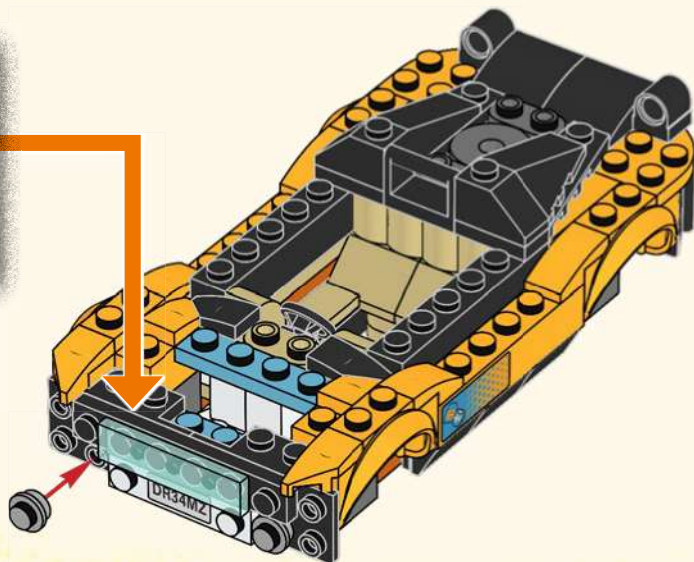
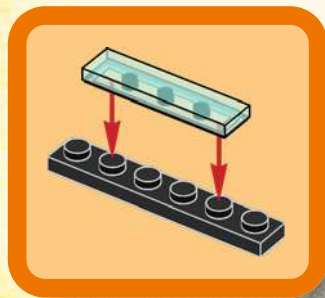



4x



2x

36

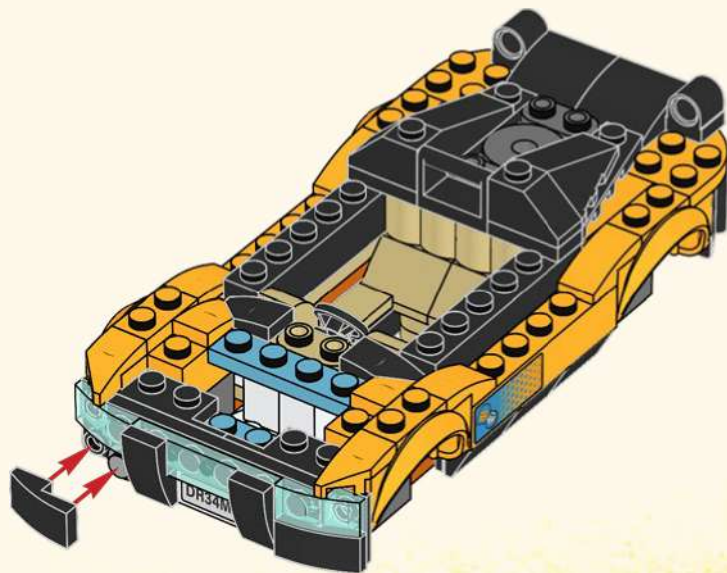



2x



2x

37

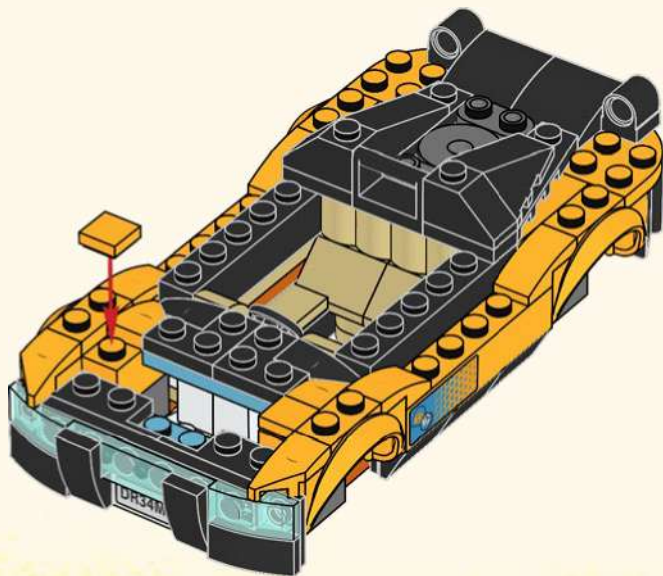



38

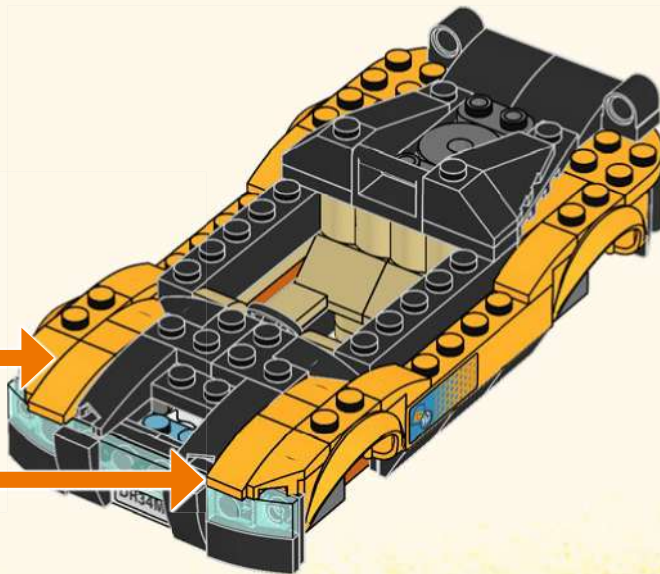



1x

39

1

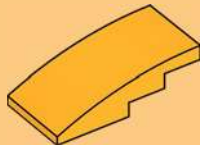

2

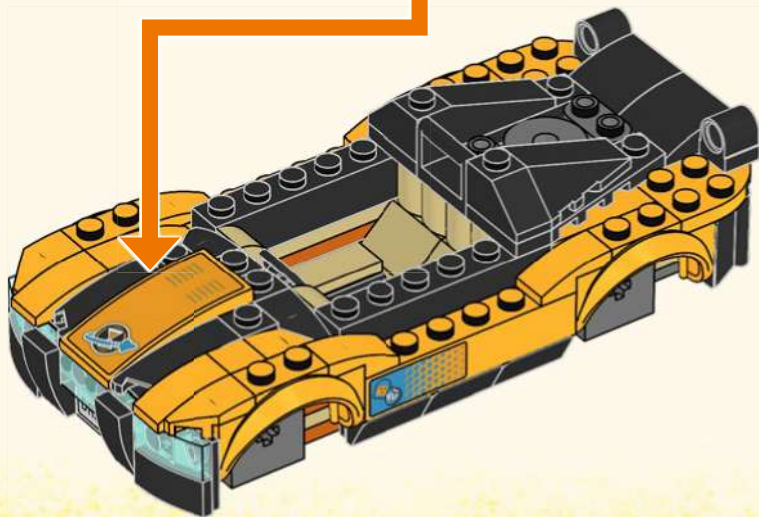

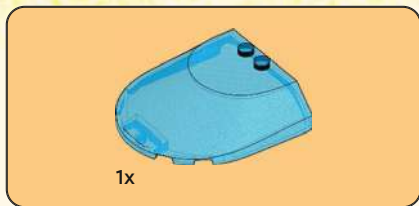

40

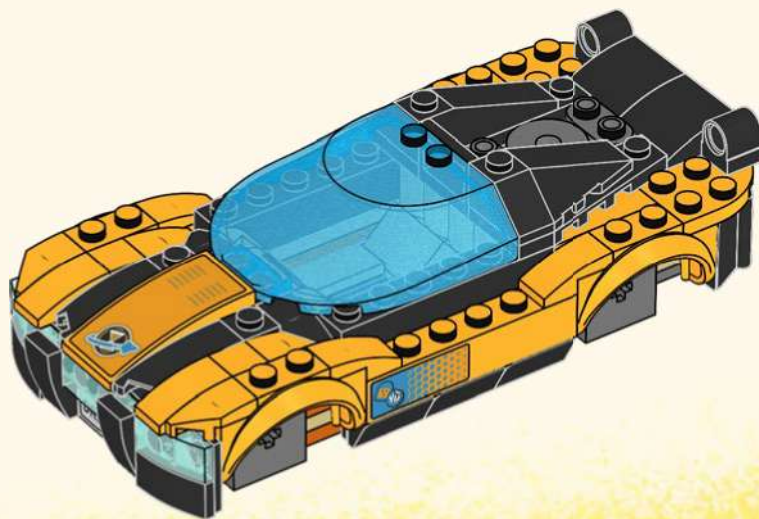



41

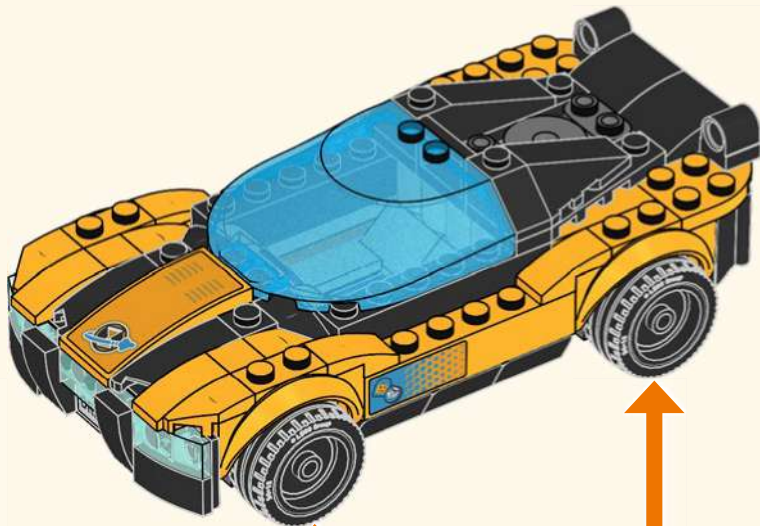
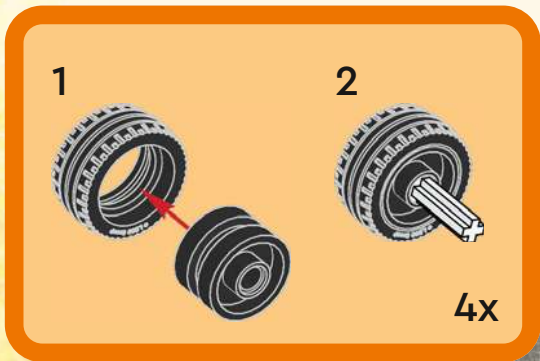



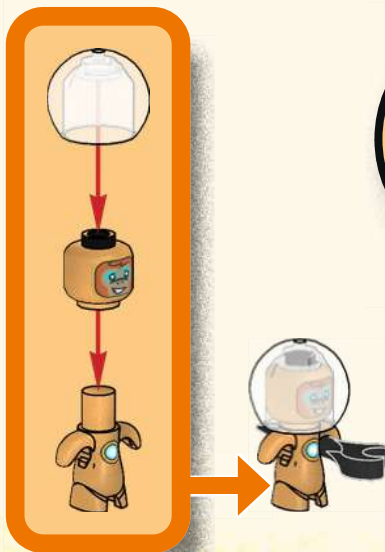

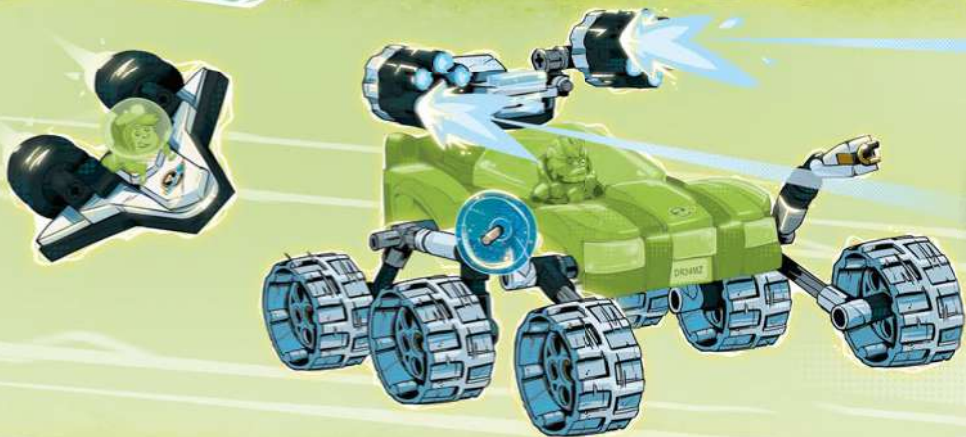
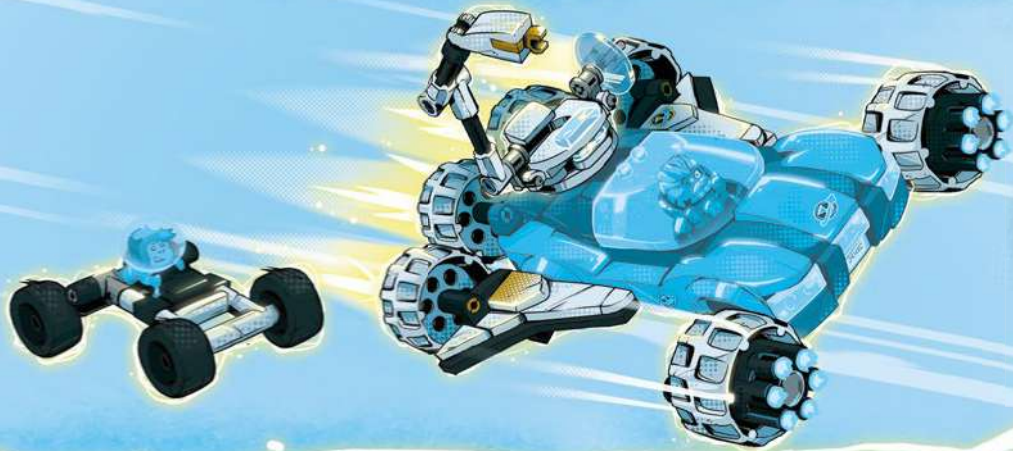

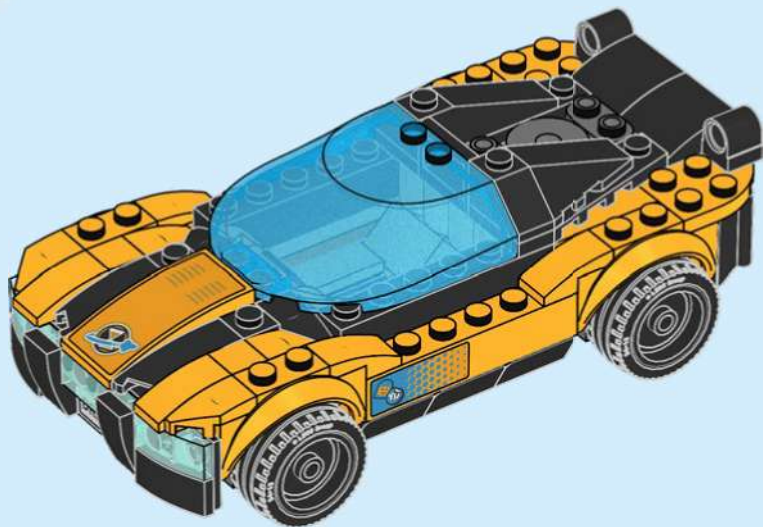

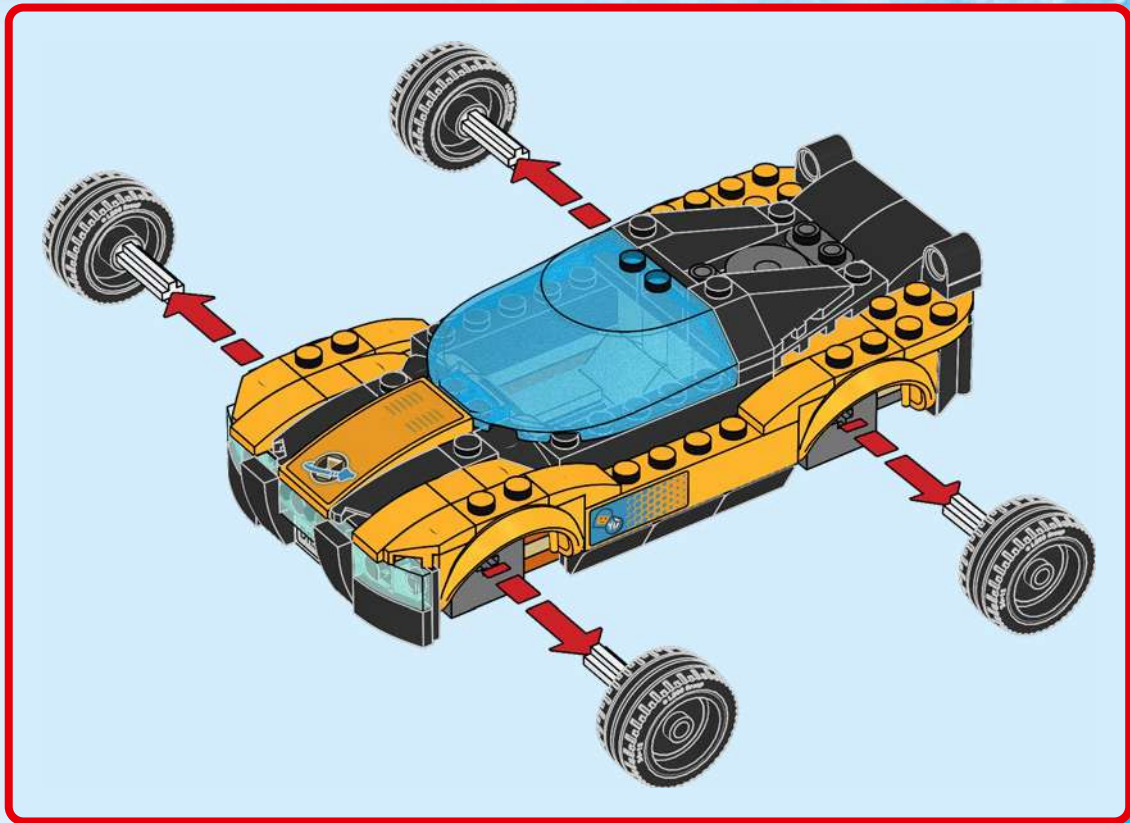

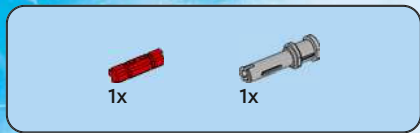

1

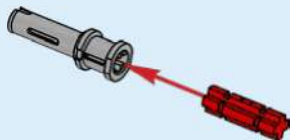

2

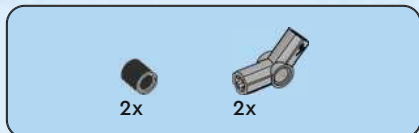

3

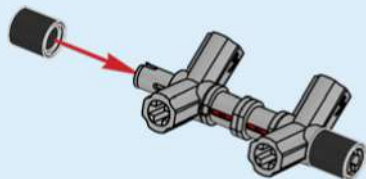



1x



1x

4

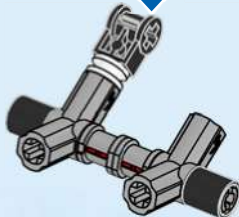
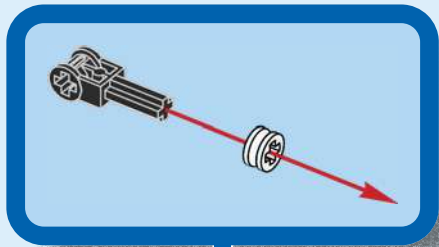

1x

5

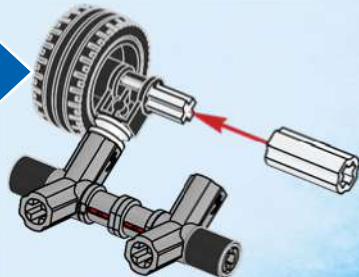



6

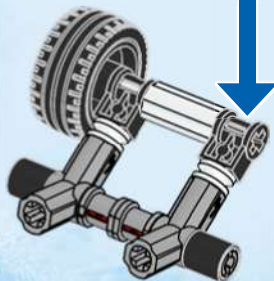
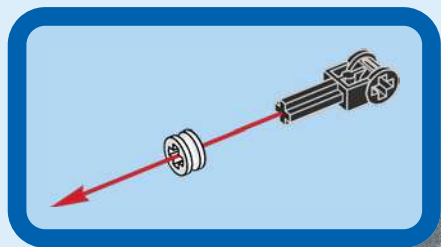

7

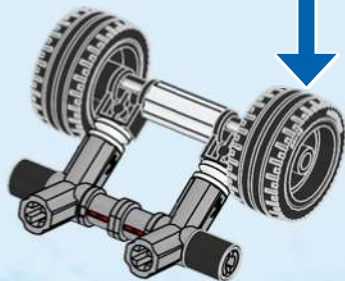

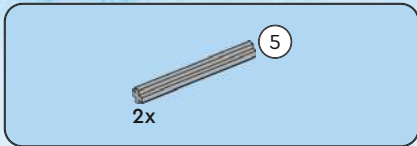

8

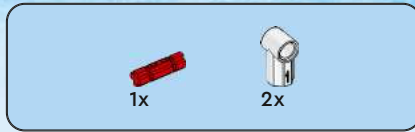
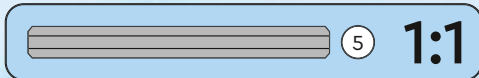
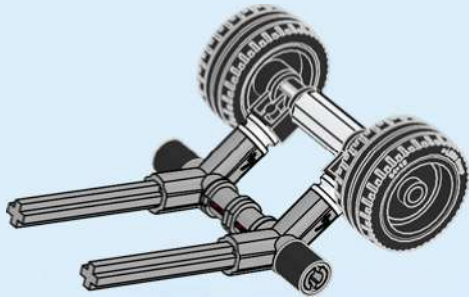

9

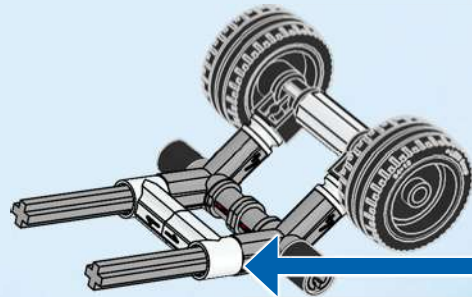
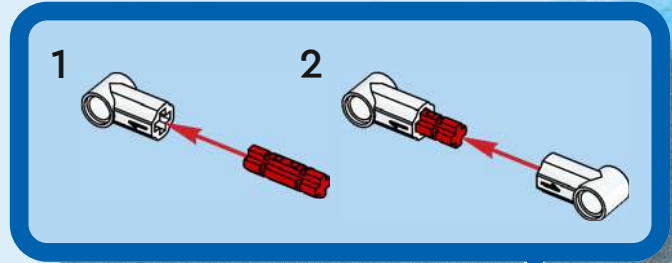



2x



1x



1x

10

1



2



3

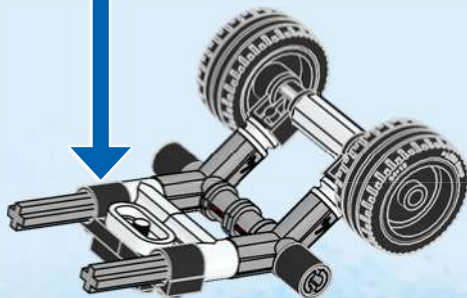
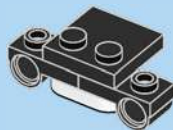



1x



2x

11

1

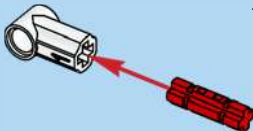

2

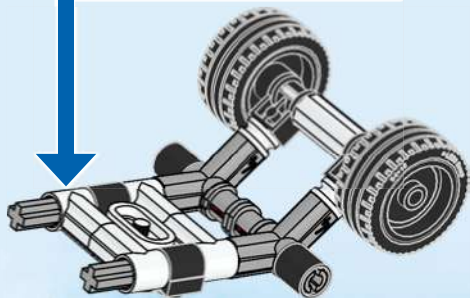
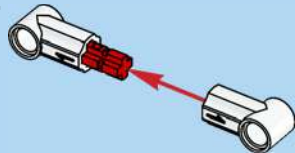

1x

12

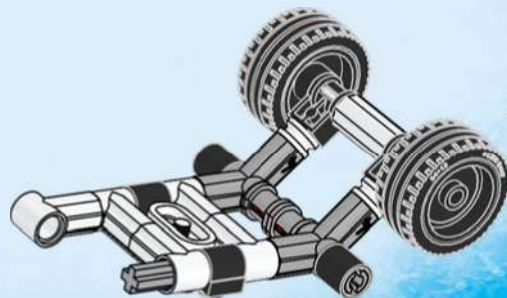



1x

13

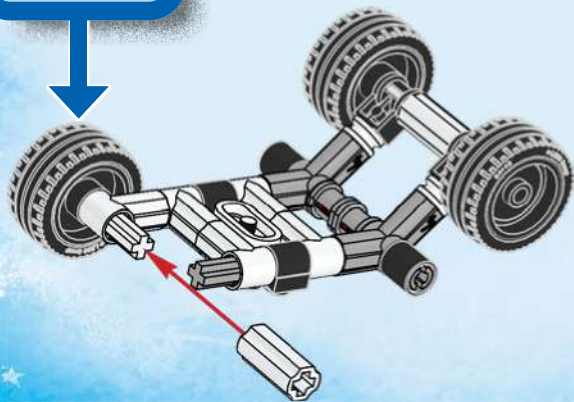

1x

14

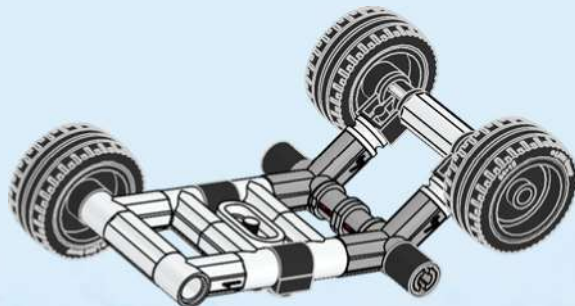

15

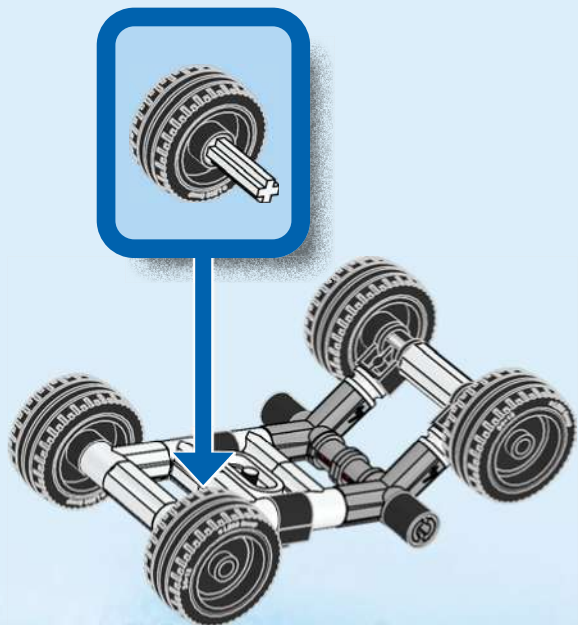

16

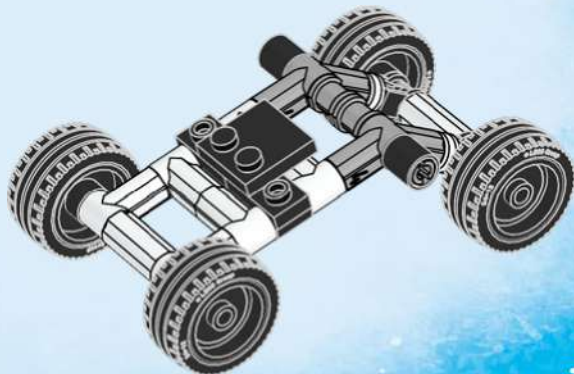

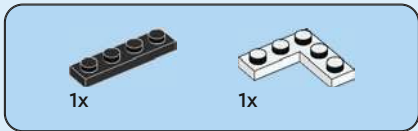
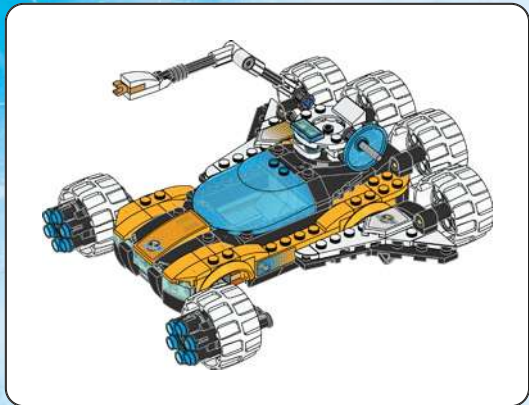

1

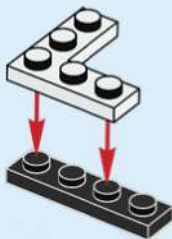



2

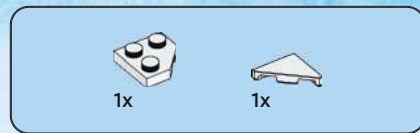

3



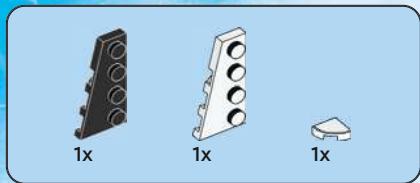

4

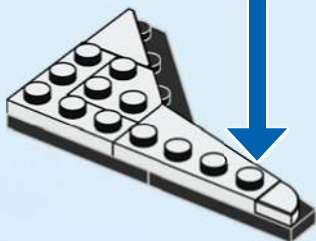
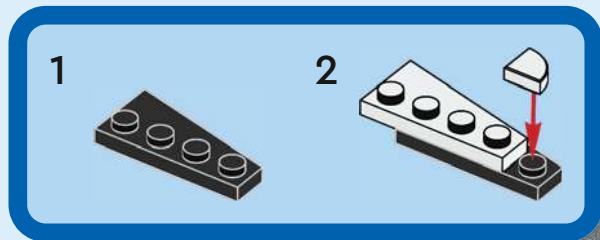

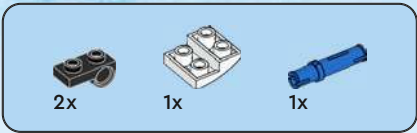

5

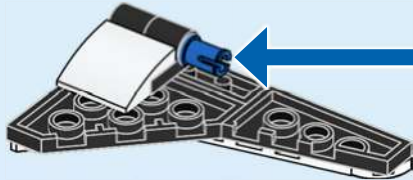
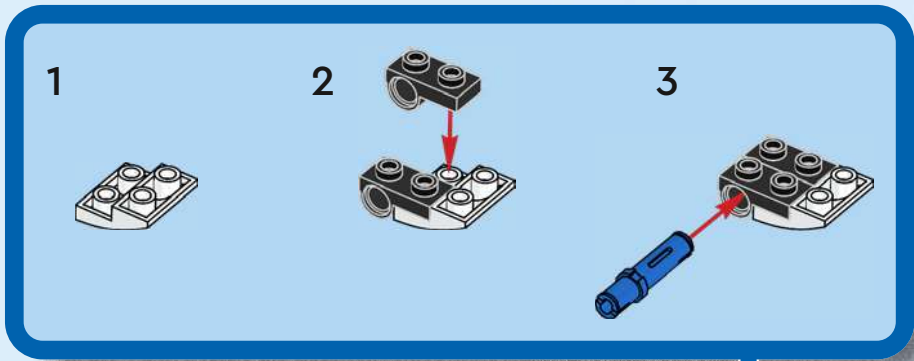



6

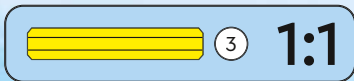
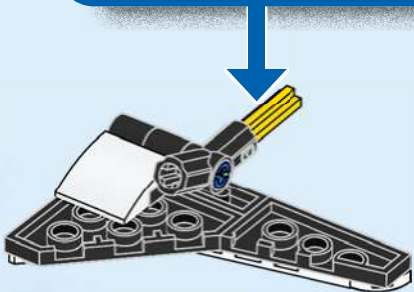
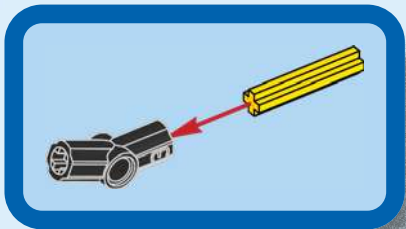

7

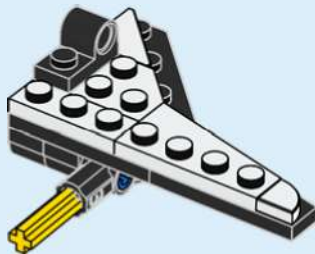



1x



1x

8

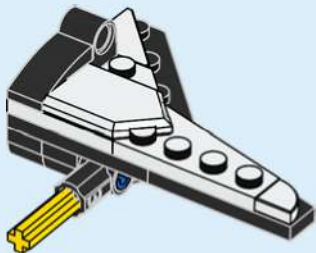

9

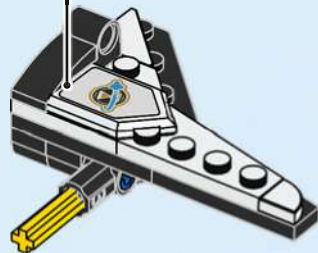

10

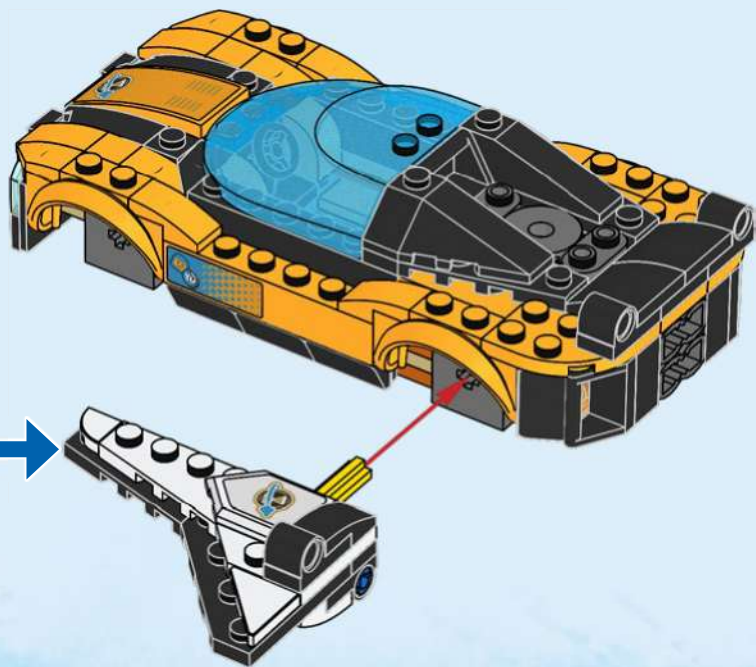

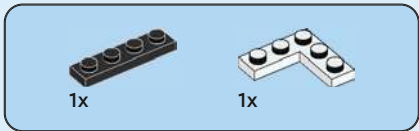

11

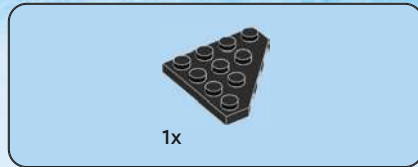
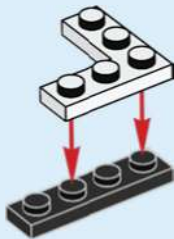

12



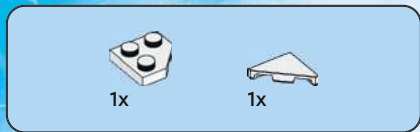

13

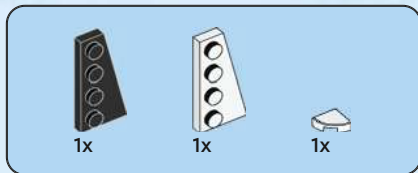

14

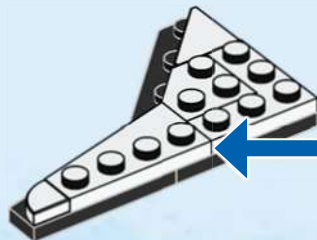
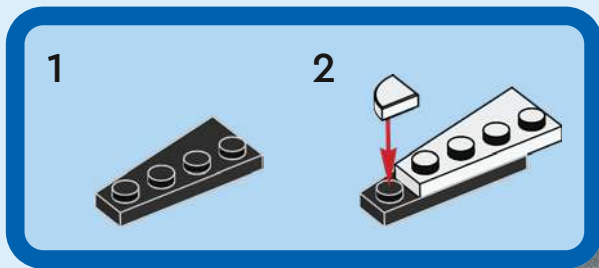

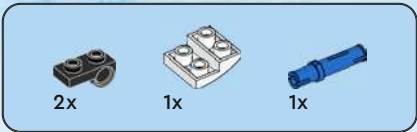

15

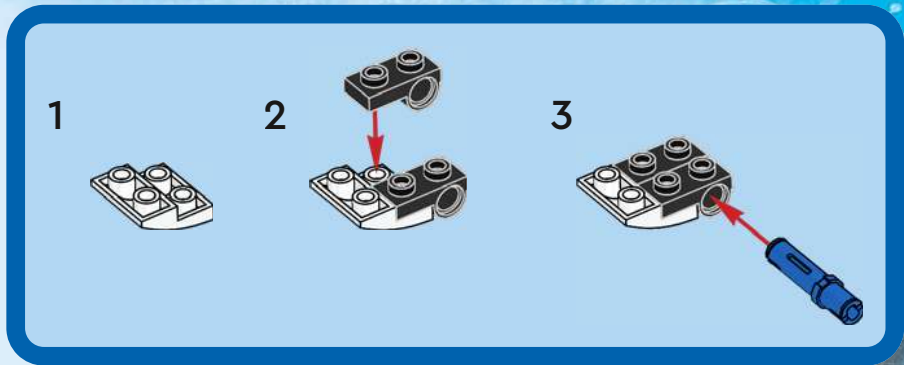



16

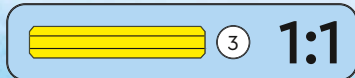
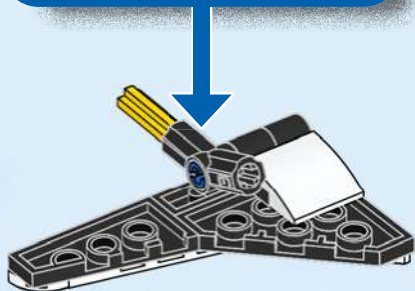
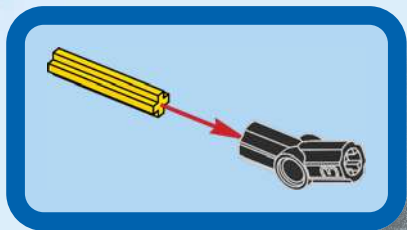

17

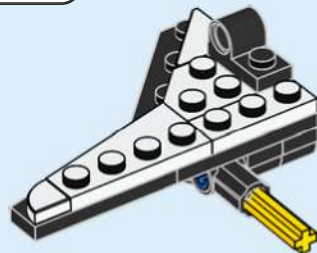



1x



1x

18

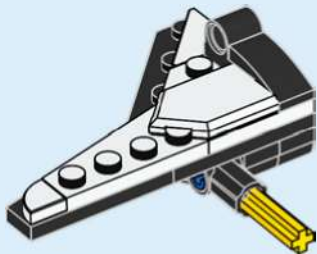

19

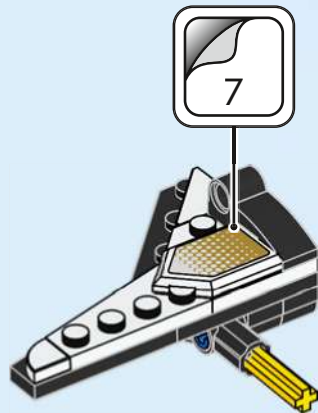

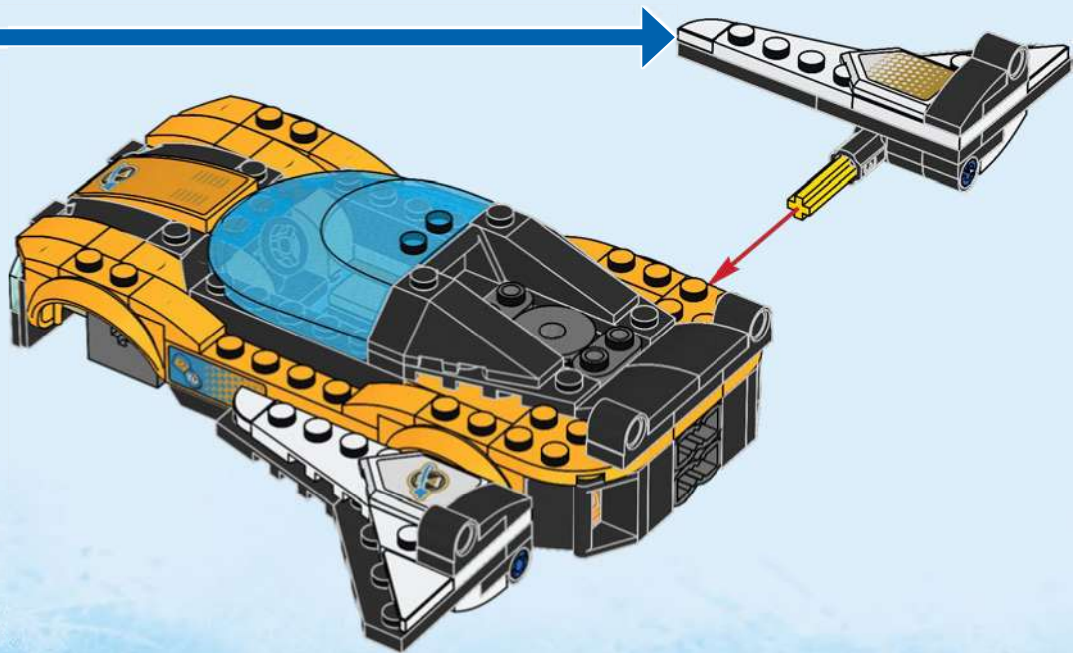

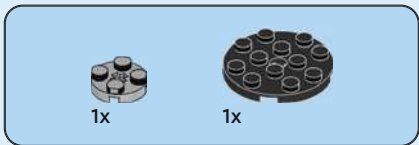

21

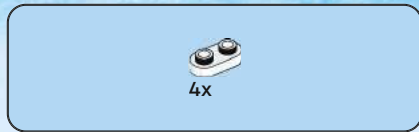
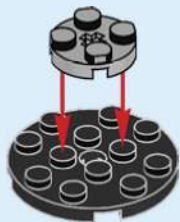

22

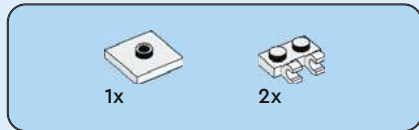

23





24



1x

25





1x



1x

26



27





1x

28

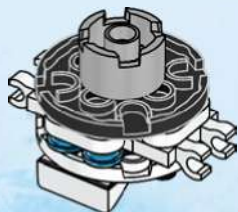

1x



1x



1x

29

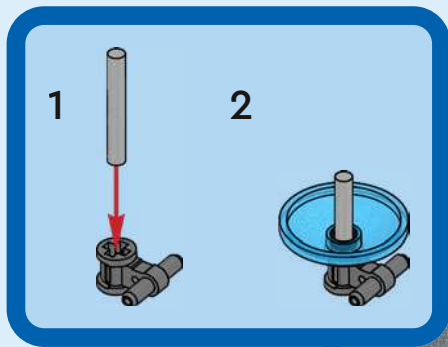



1x



1x

30

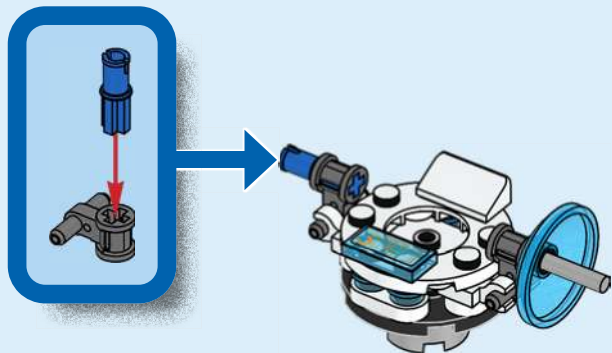

1x

31

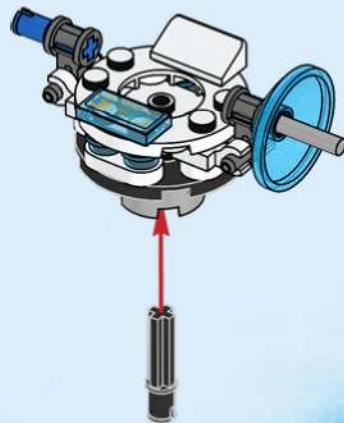

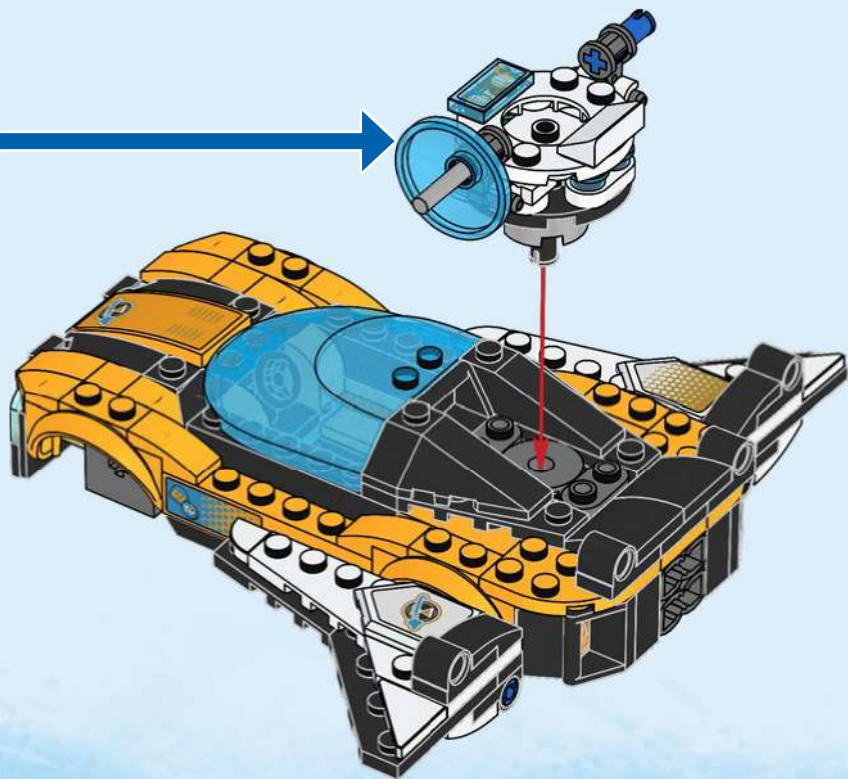

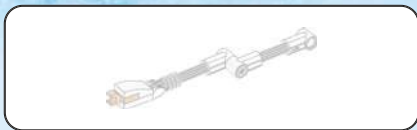

33

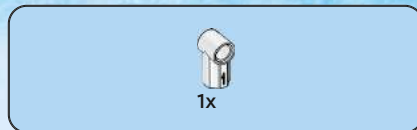
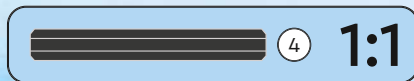

34

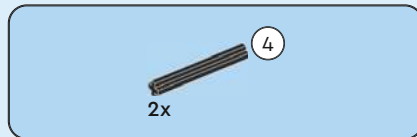

35





1x



1x

36

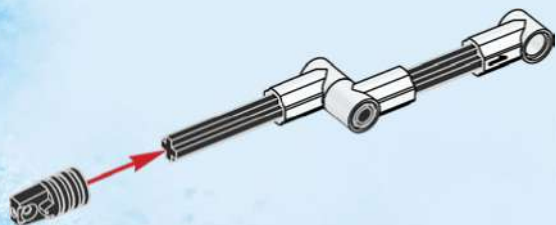

1x



1x



1x

37

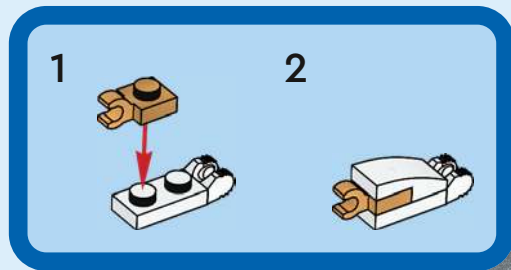

1

2

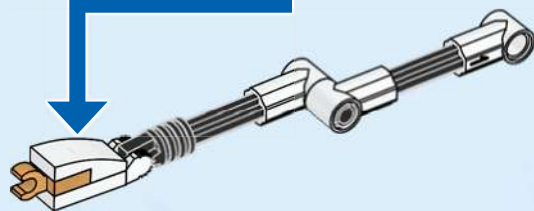

38

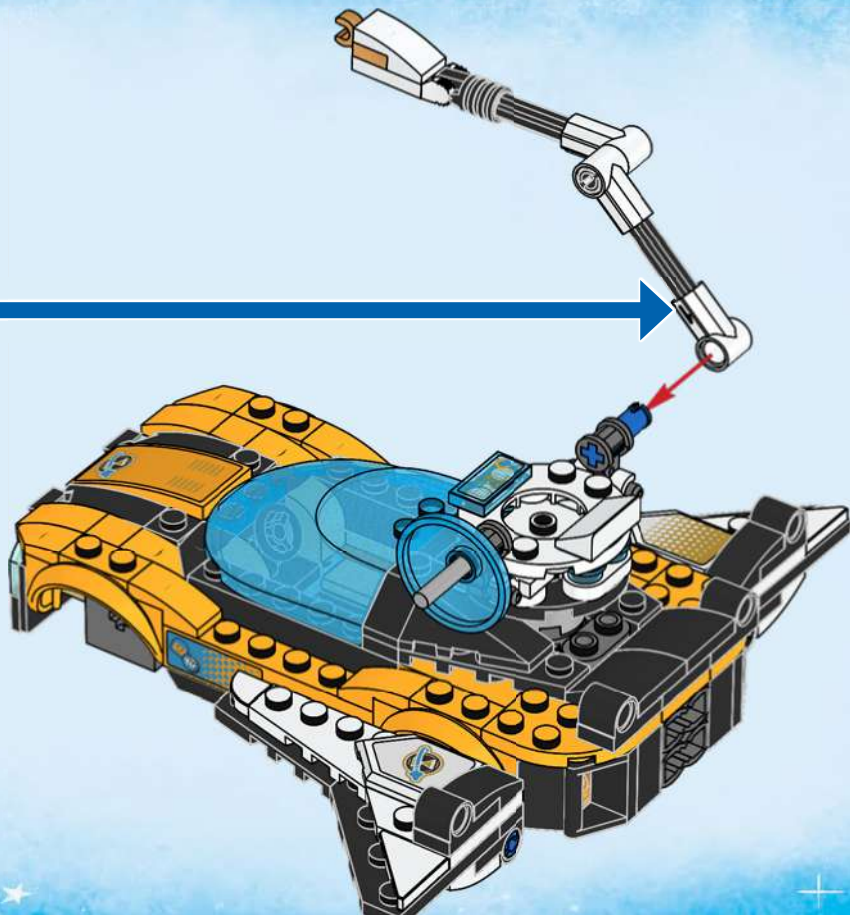



4x



4x



4x



4x



4x



4x

39

1

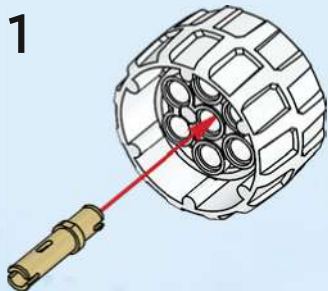

2

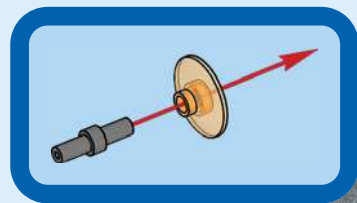

3

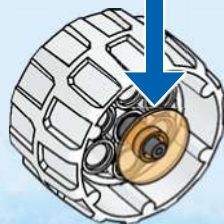

4x

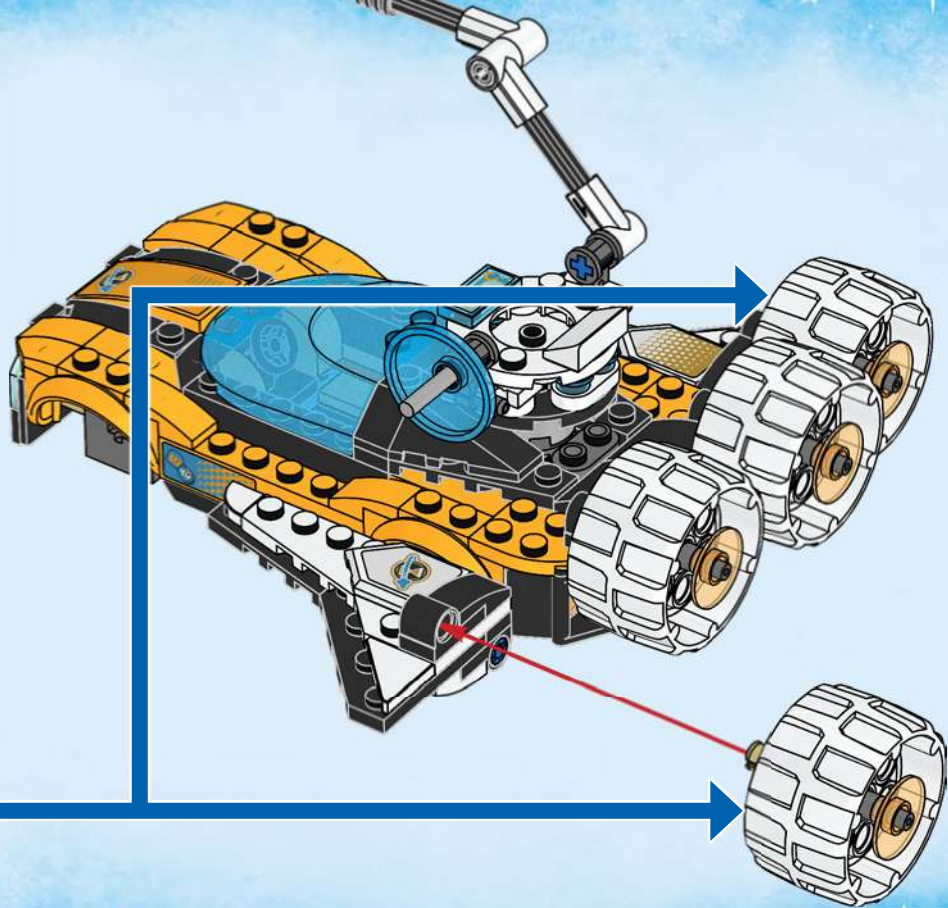



2x



1x



1x

40



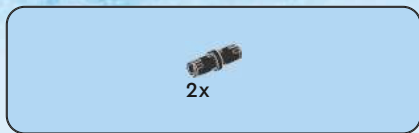

41

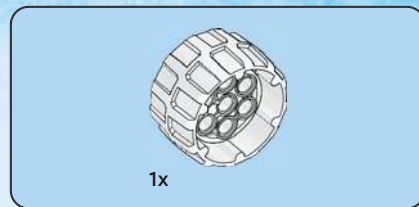
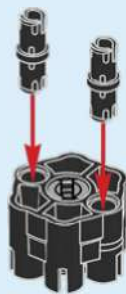

42

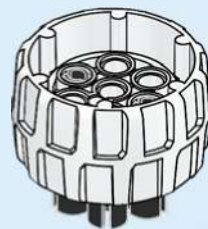

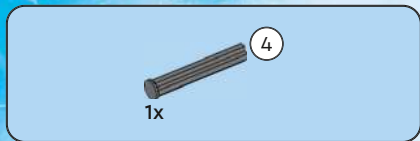

43

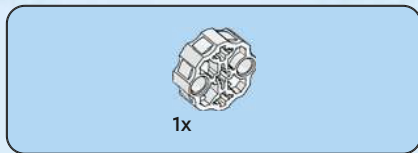
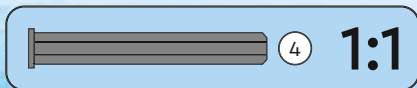

44

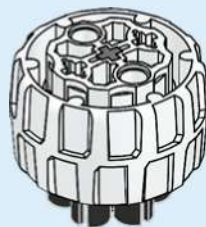

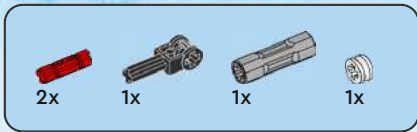

45

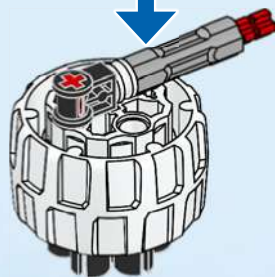
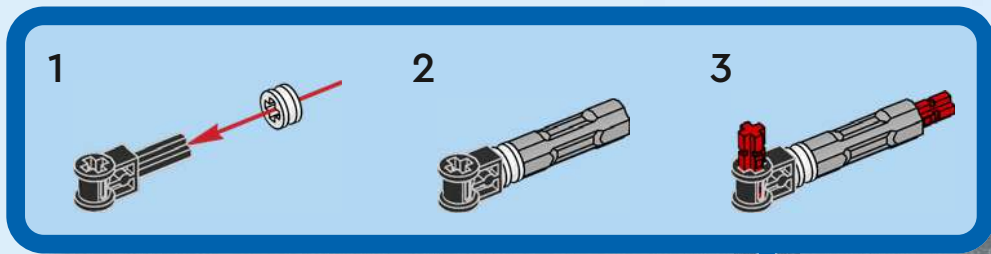

2x

46

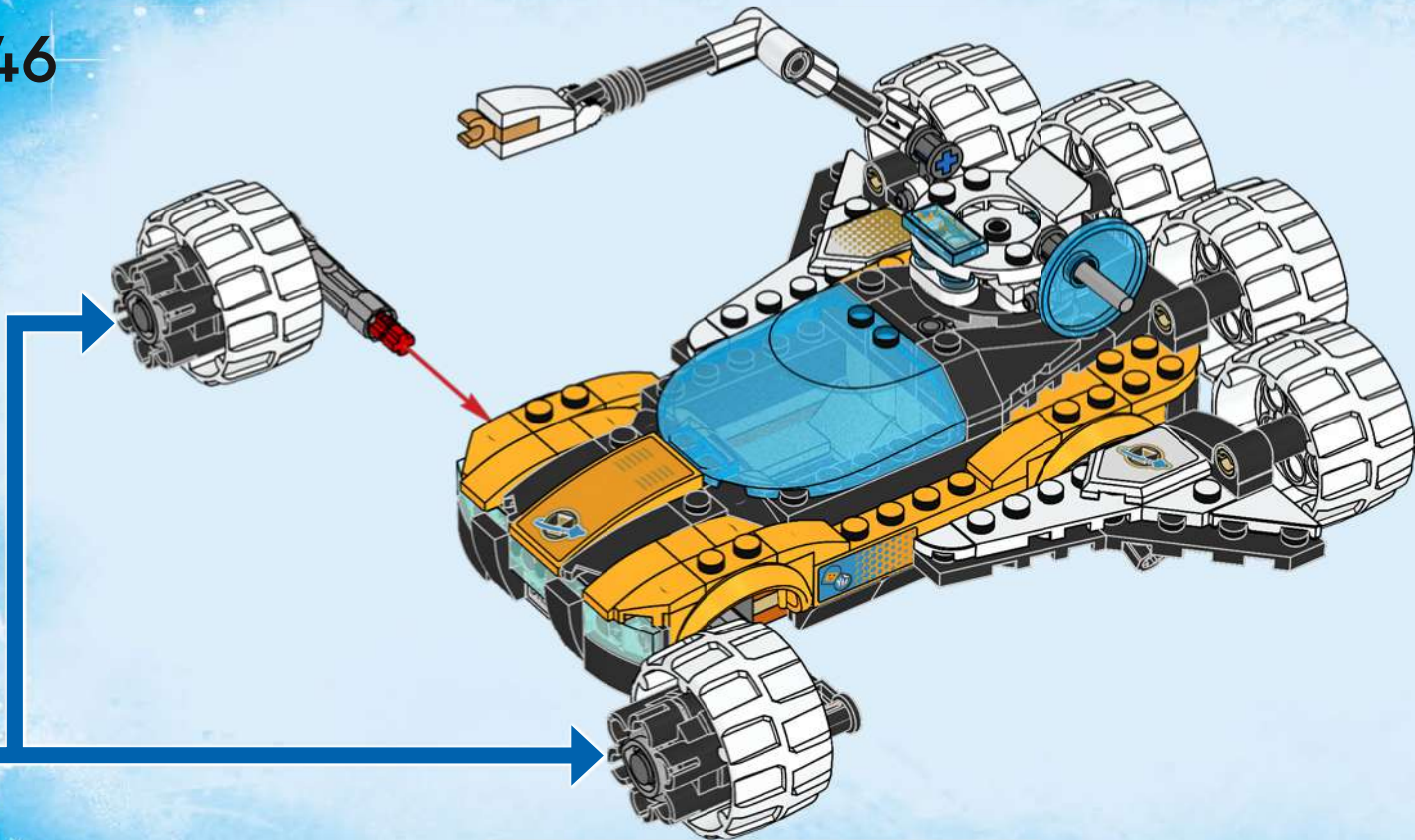

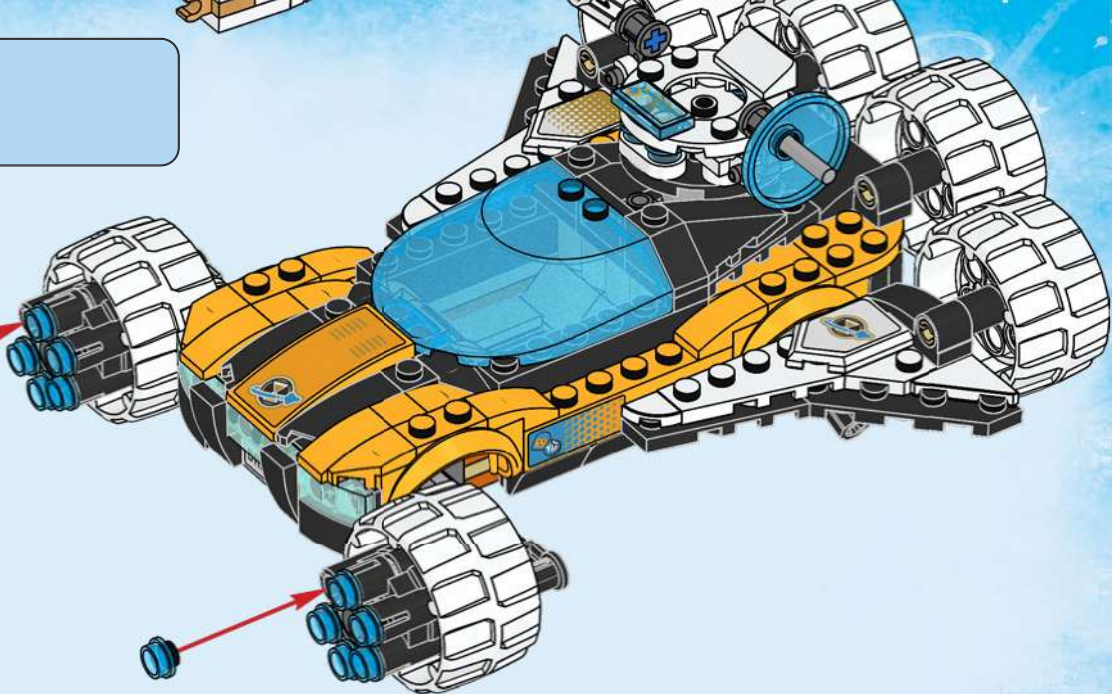

18x

47

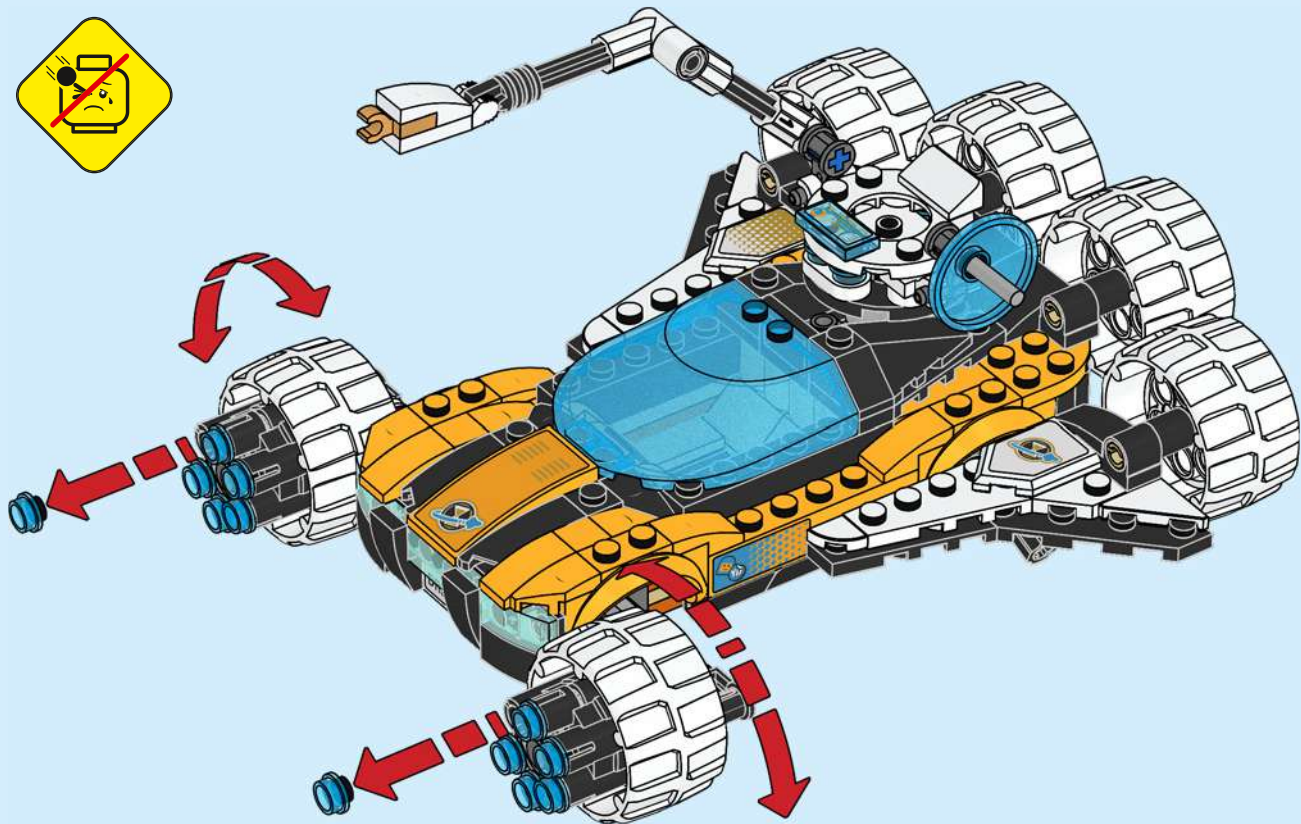



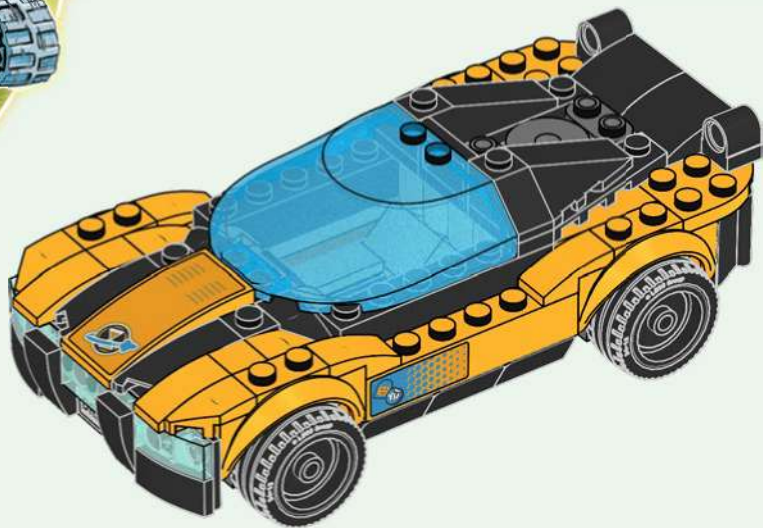



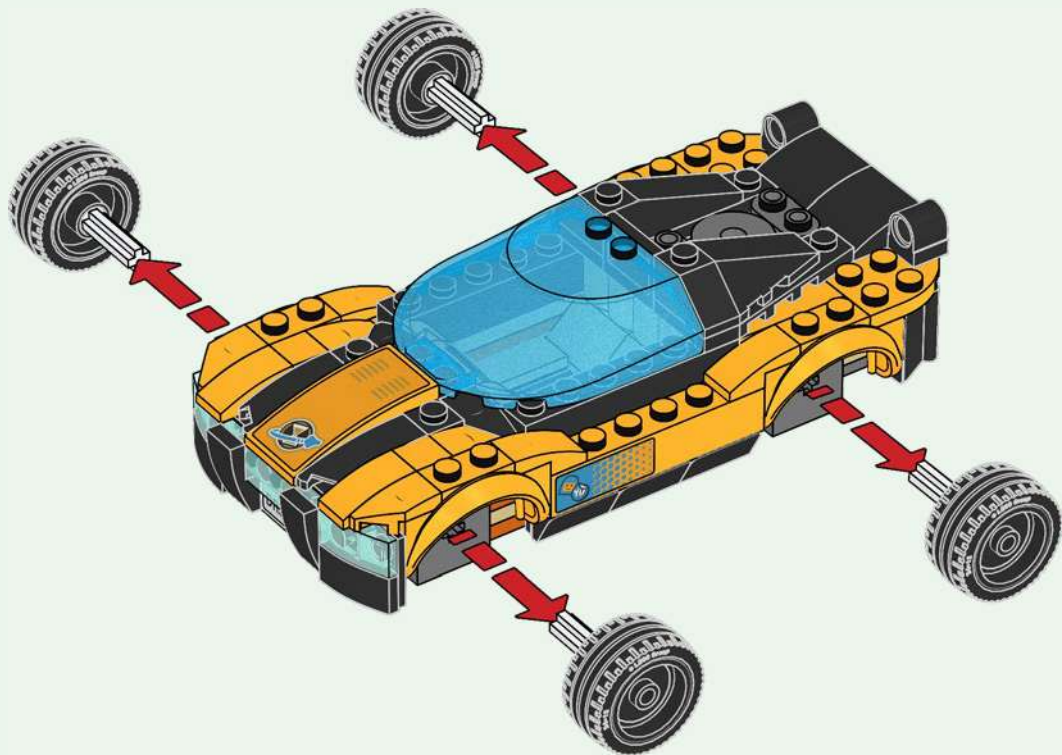

1



2



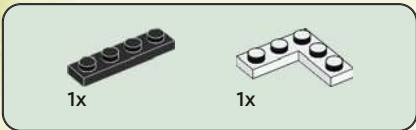

1



2





1x



1x

3



1x

4

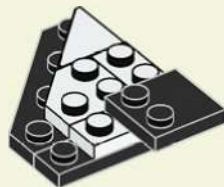

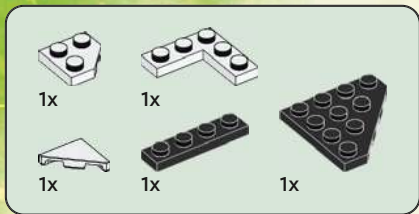

5

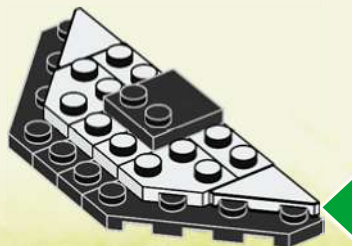
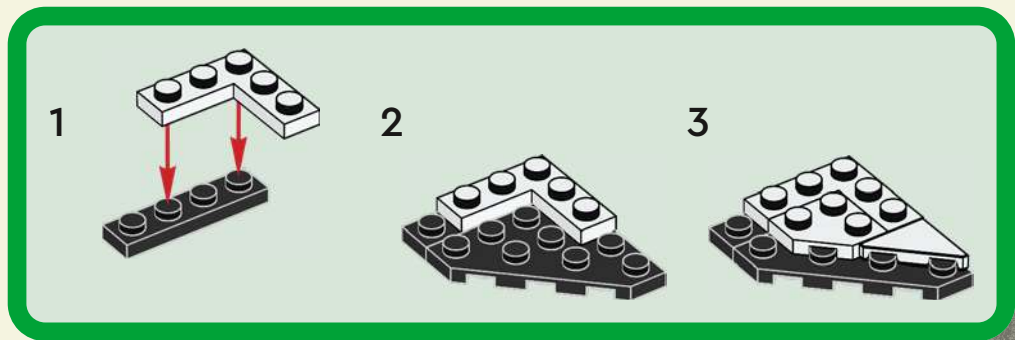

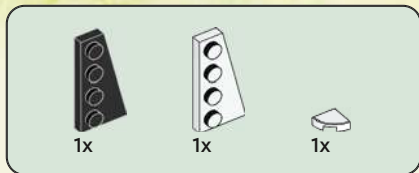

6

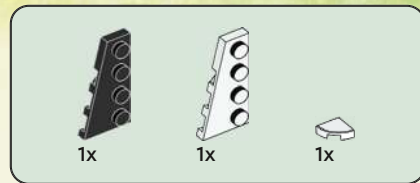
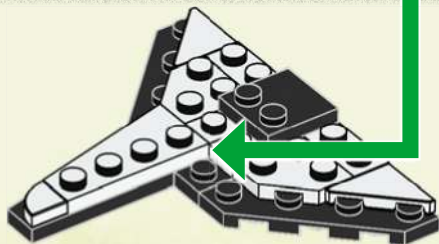
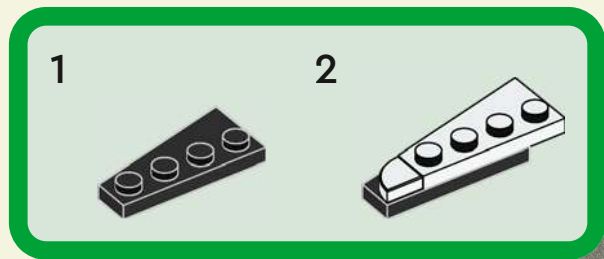

7

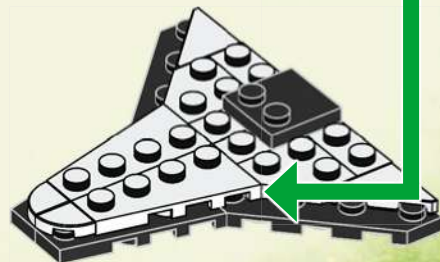
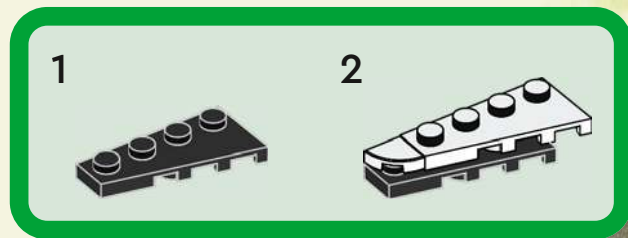



2x

8



2x



1x



1x

9

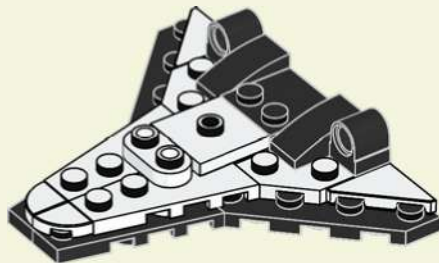



2x

10



11





6x



3x

12

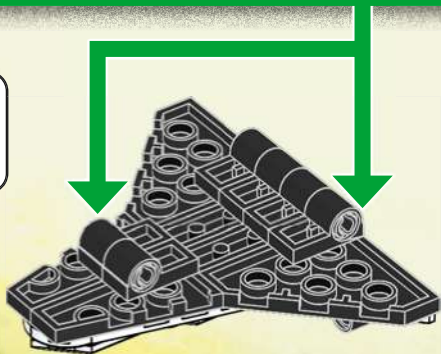
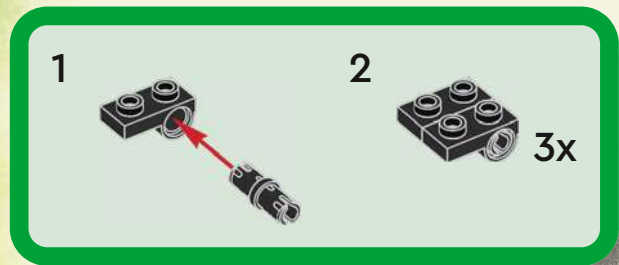

2x

13





2x



2x



4x



2x



4x



4x

14

1



2



3



4

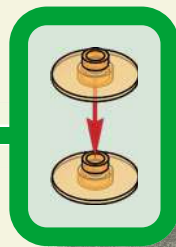

5

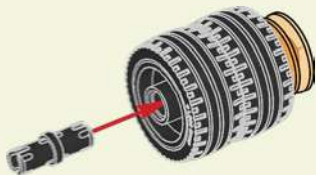

2x

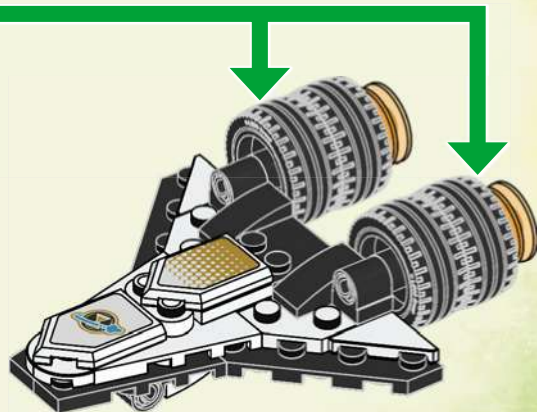

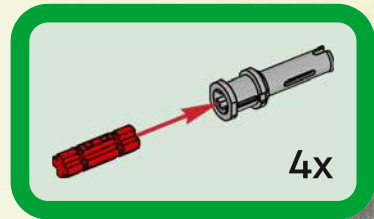
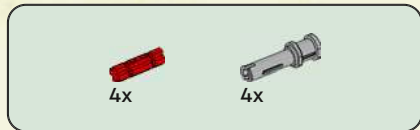

1

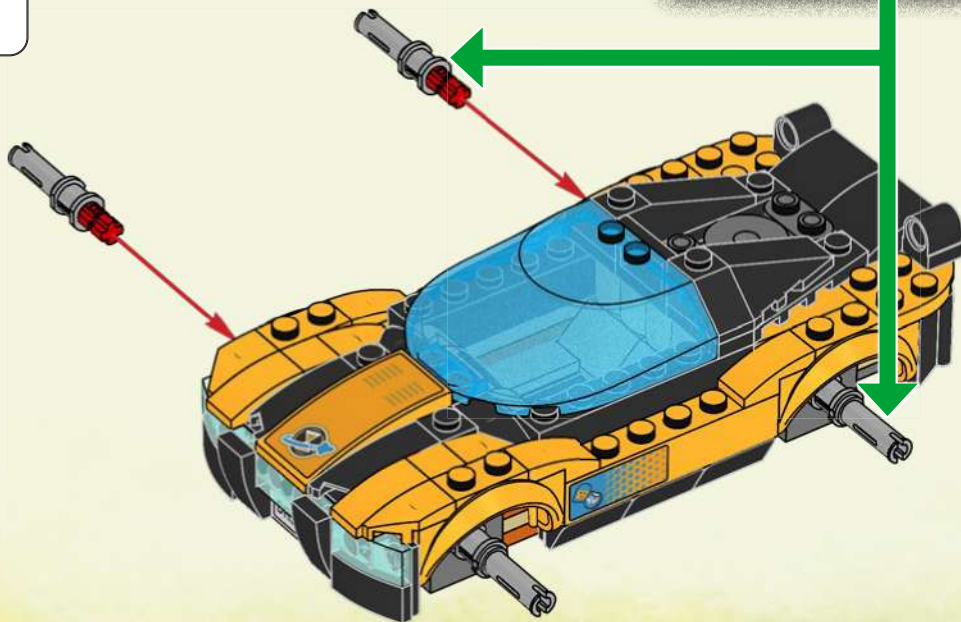

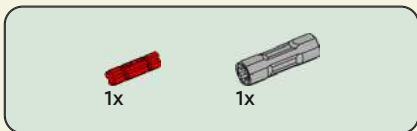

2

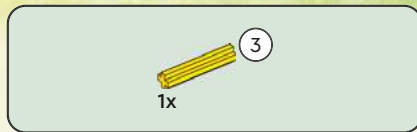
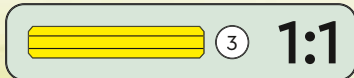
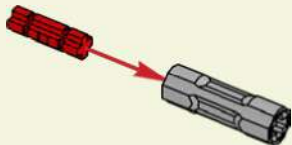

3

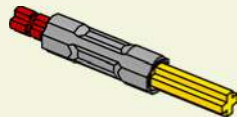

4



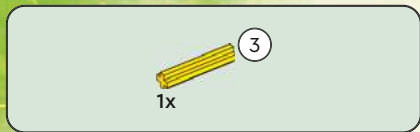

5

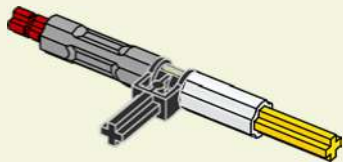

6

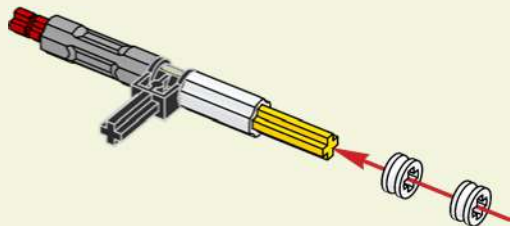



1x



1x

7

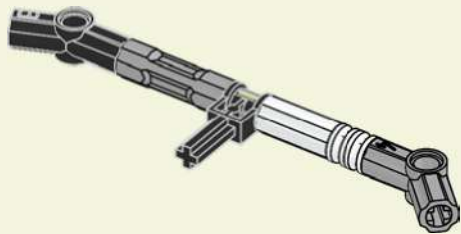

1x



1x

8

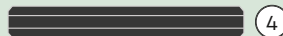
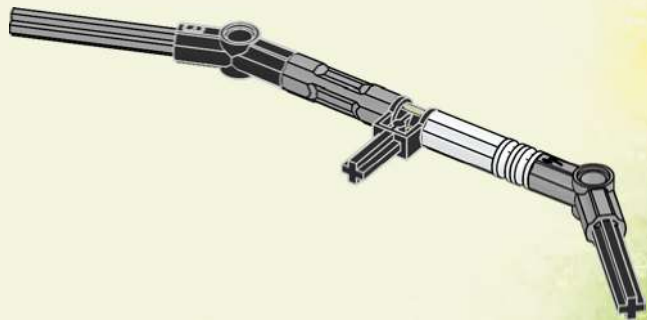

4



5

1:1



3x

9

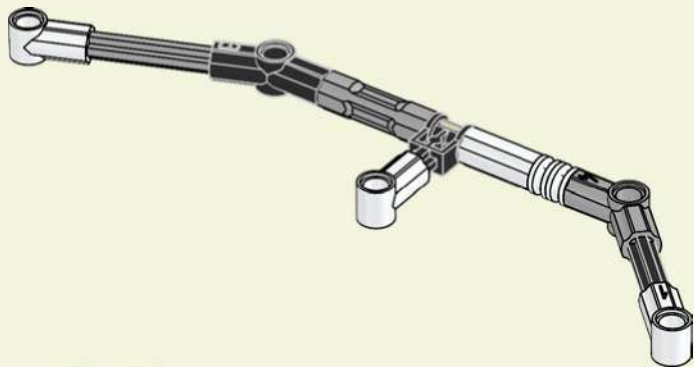

2x

10

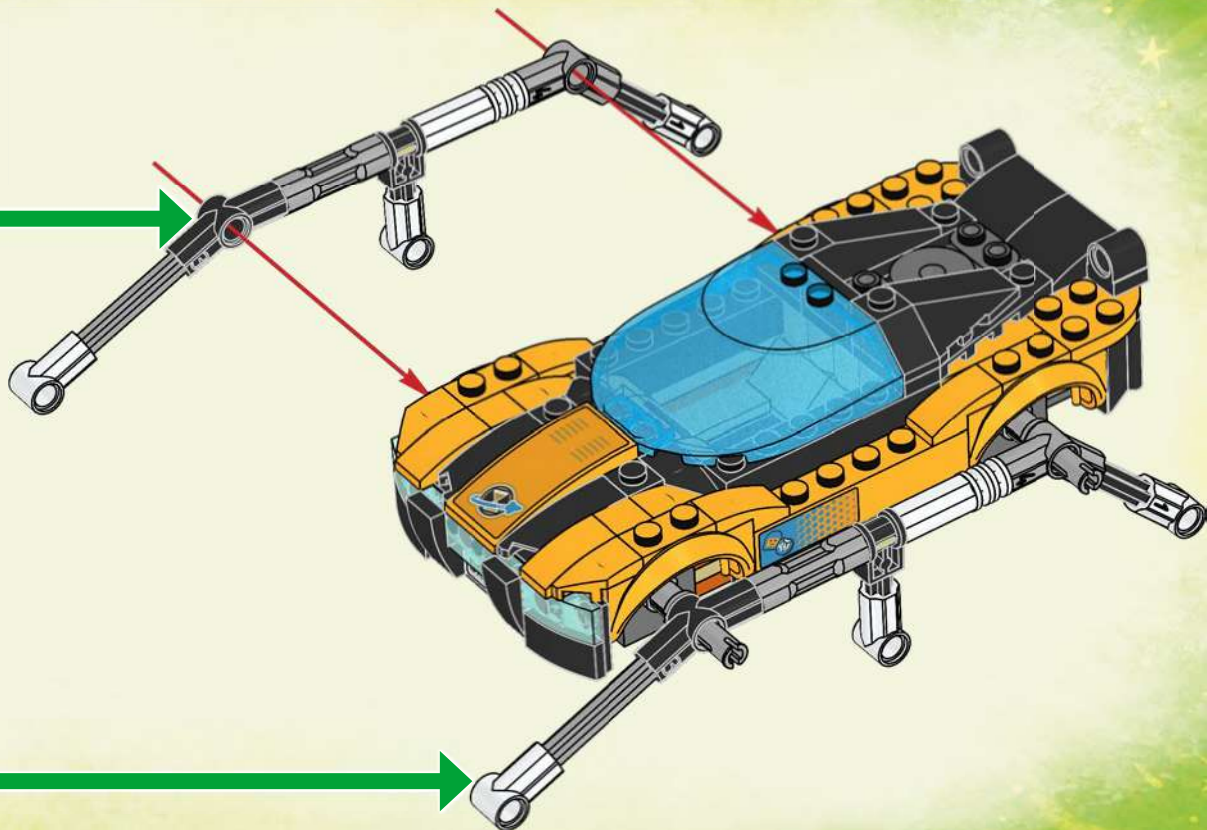



11

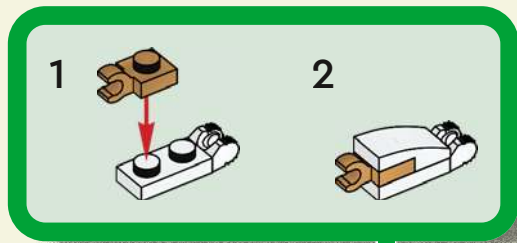
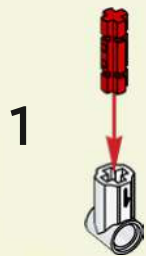

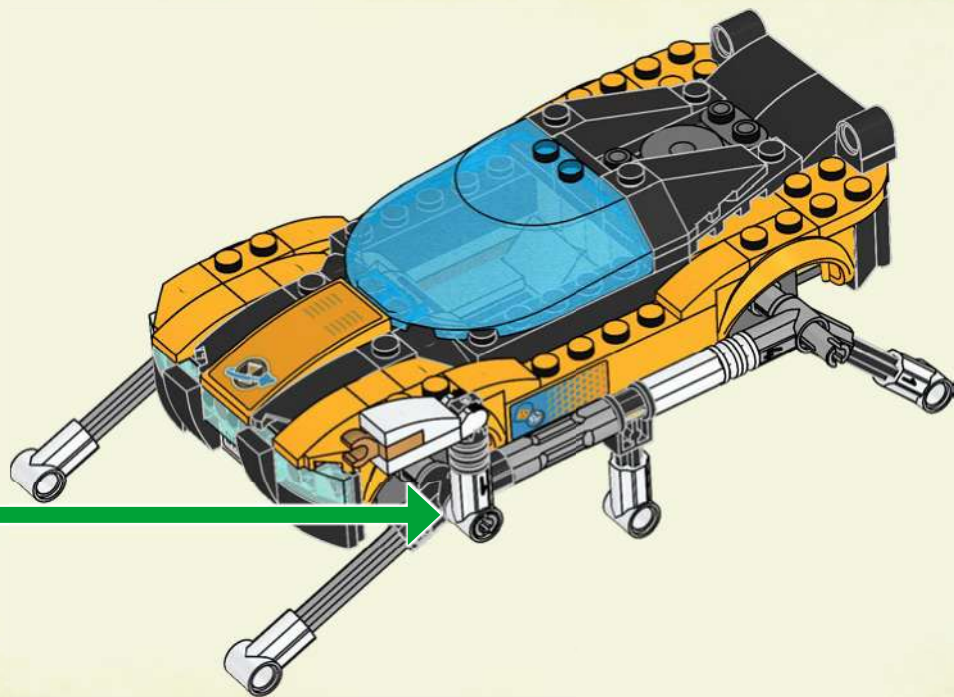



1x



1x



2x



1x

12

1

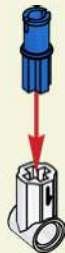

2



3



4



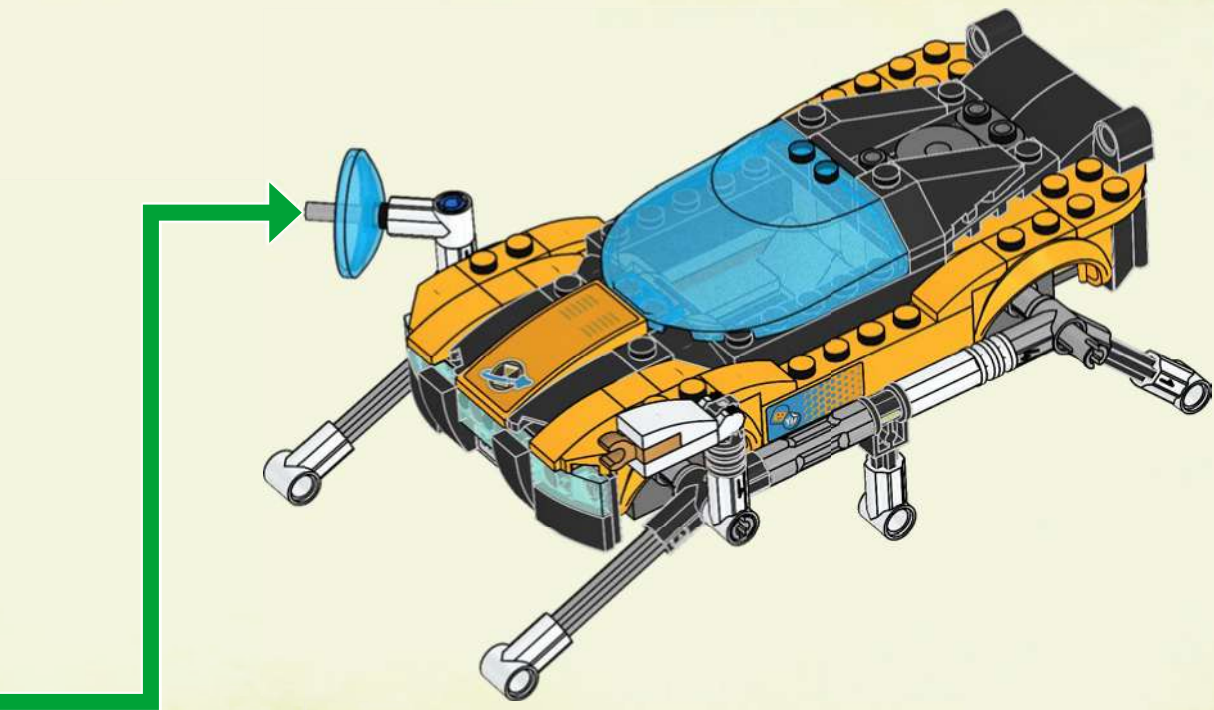

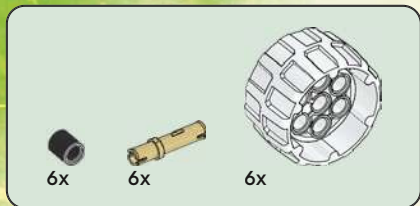

13

1

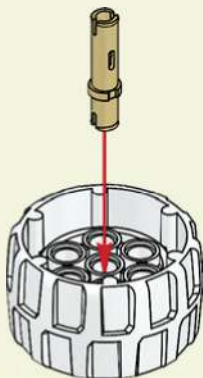

2

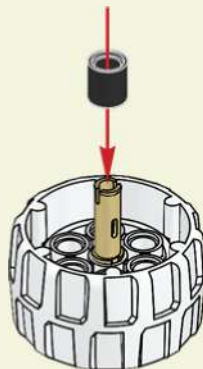

6x

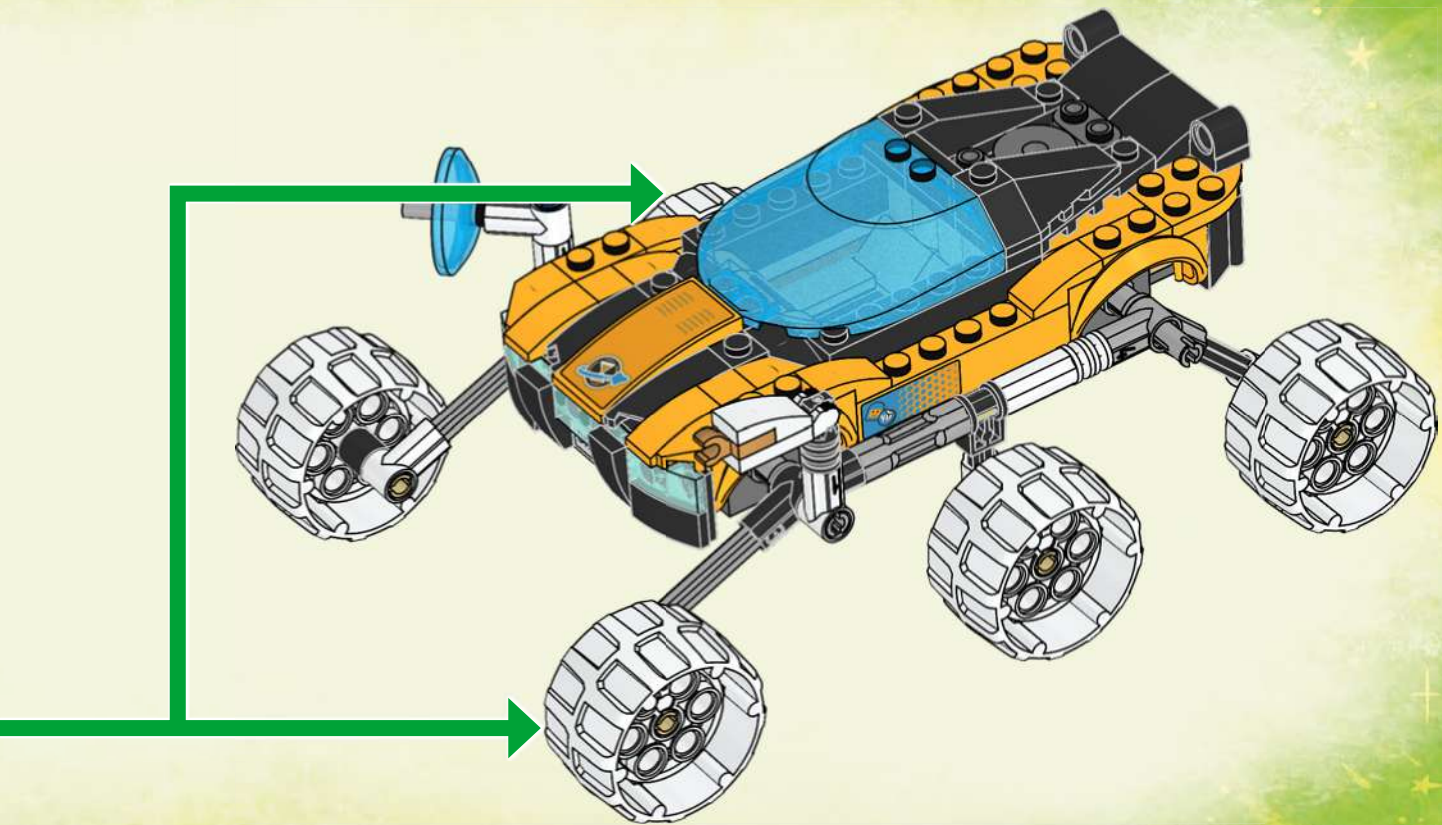

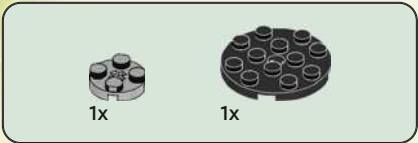
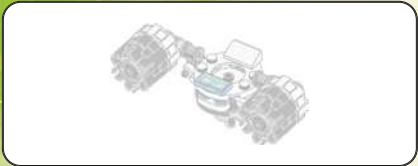

14





4x

15



1x



2x

16





4x

17



1x

18





1x



1x

19



20





1x

21

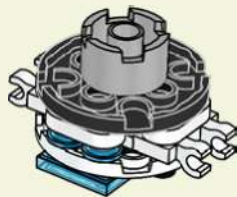



2x

22



1x

23

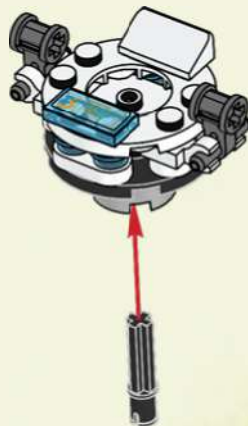



2x



4

1:1



1x



1x

24



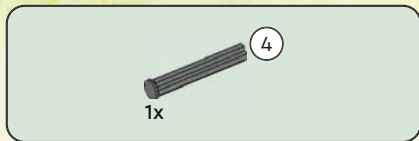

25



26





1x



1x

27

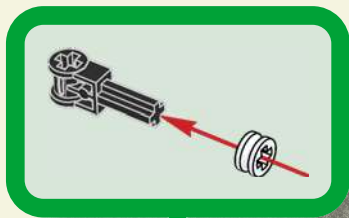

2x

28

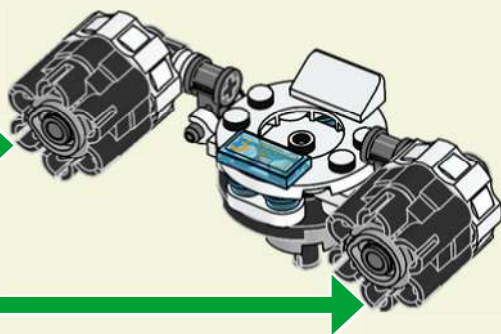

29

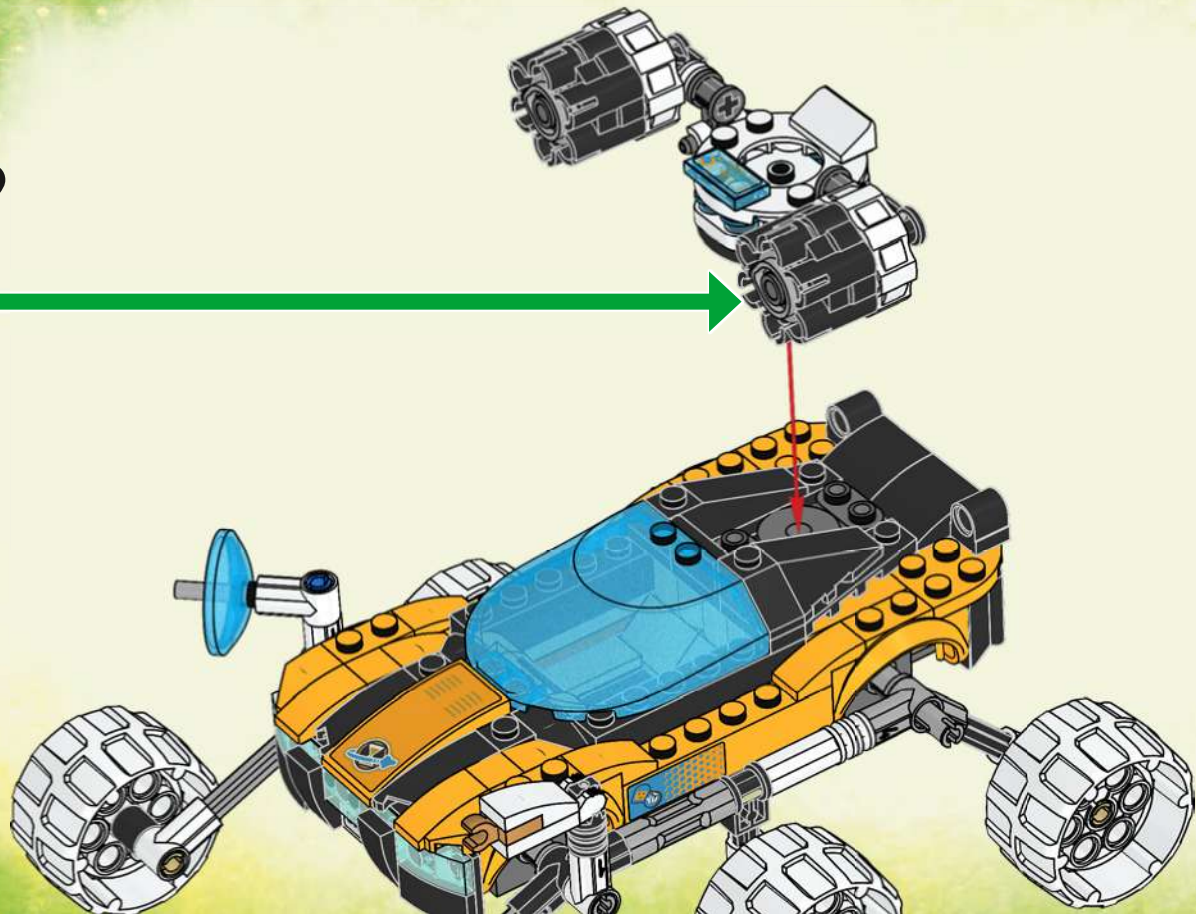

18x

30

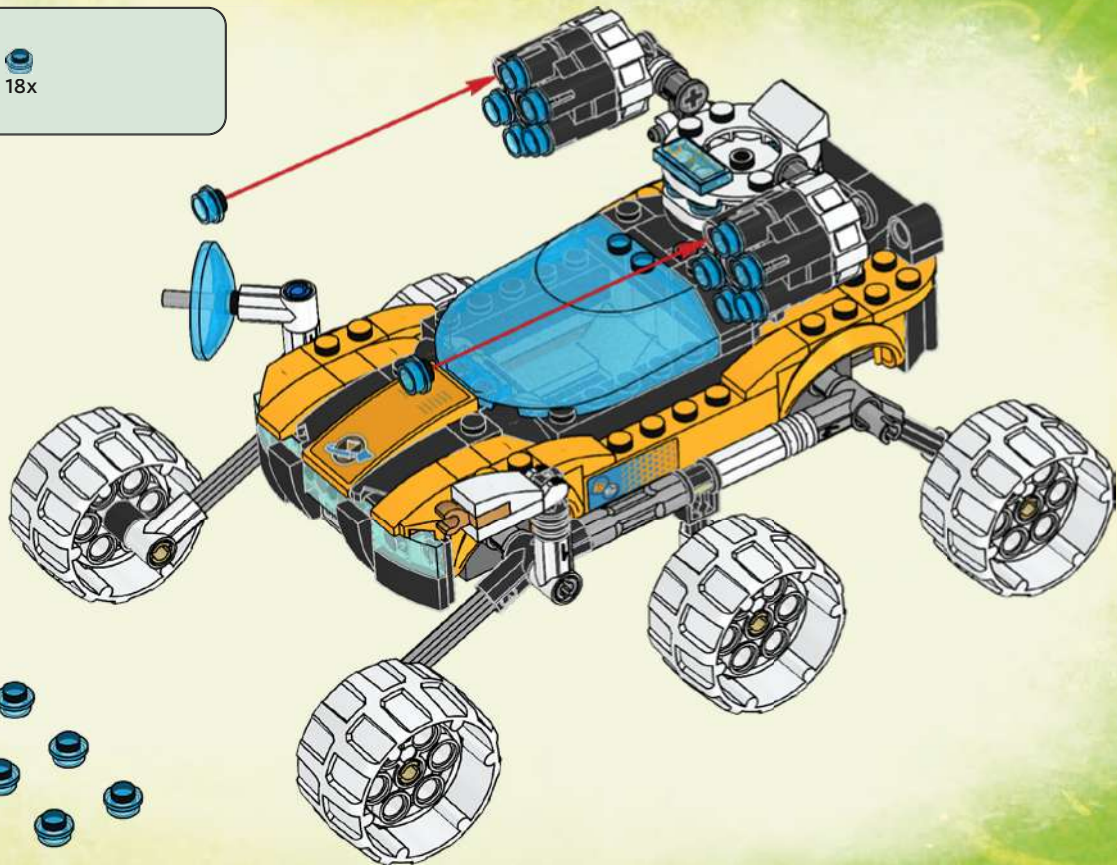

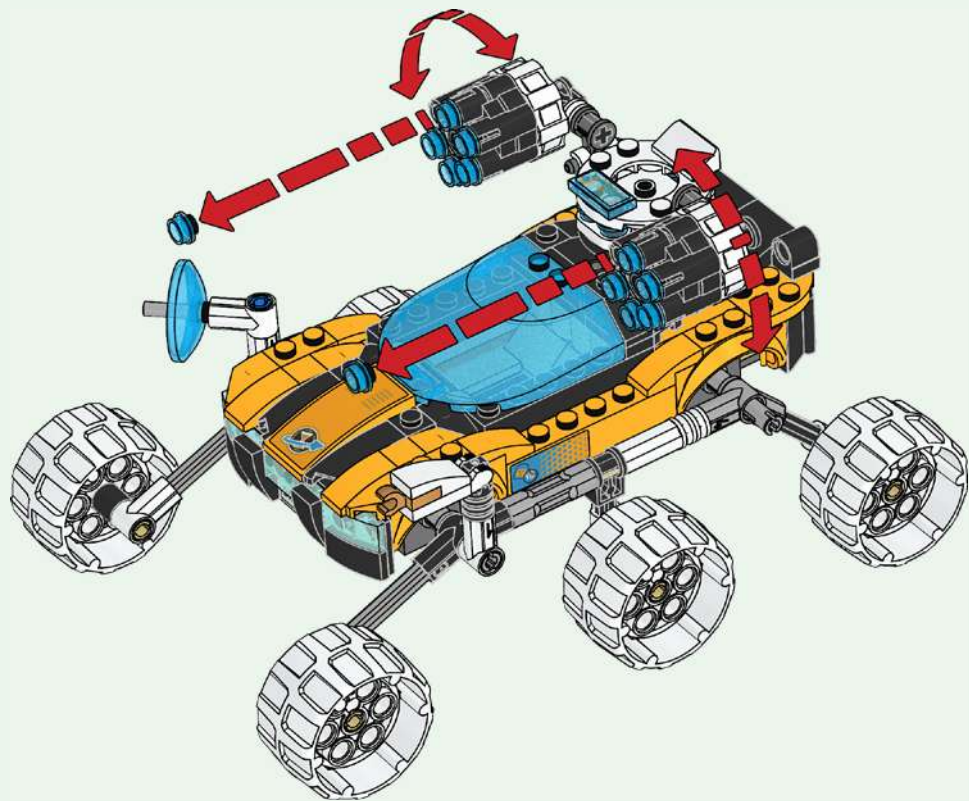



LEGO

DREAMZZZ



71471



71472



71475



71476



71477

Watch series online
Schau dir die Serie online an
Regarde la série en ligne
Guarda la serie online
Mira la serie en Internet
Assistir à série online
在线观看
Oglądaj serial w internecie
Sleduj seriál online
Pozri si seriál online
Nézd a sorozatot online
Vizionează serialul online
Гледайте сериала онлайн
Skaties seriālu tiešsaistē
Vaata sarja veebist
Žiūrėk serialą internetu



LEGO



DREAMZZZ



**WATCH
SERIES
ONLINE**



7 LEGO.com/DREAMZZZ

 6x 6360263	 1x 4547489	 1x 6267044	 6x 6321305	 7x 4142865	 1x 6181720	 8x 4548180	 1x 6250020	 1x 400626
 1x 6168642	 2x 6212049	 2x 6263181	 2x 4114322	 2x 235721	 2x 6335388	 5x 6279875	 1x 6093525	 4x 6102596
 9x 6332573	 1x 6034044	 2x 6245249	 2x 6131896	 1x 4206482	 1x 473326	 2x 6275806	 4x 6312496	 2x 6360819
 2x 6172366	 2x 6176240	 6x 6472788	 1x 6468819	 2x 6299413	 1x 6405102	 3x 243226	 4x 6290263	 2x 6360819
 5x 6210272	 2x 6347287	 1x 6249091	 7x 4124067	 1x 6434207	 1x 6265699	 4x 6114987	 2x 242026	 2x 6118829
 1x 4179875	 2x 6217875	 1x 6249091	 4x 6130007	 1x 6434205	 2x 4160869	 1x 73081	 2x 6053077	 2x 370526
 1x 4179874	 2x 6126046	 1x 6392162	 2x 614121	 4x 6469663	 1x 6469663	 3x 302326	 1x 6192346	 2x 4160025
 1x 4160857	 2x 235701	 2x 6428165	 1x 4180504	 4x 6315887	 2x 4161332	 6x 6047276	 1x 6089119	 2x 4160025
 1x 4160857	 2x 6210385	 3x 6212758	 1x 4180533	 3x 614126	 1x 6181713	 6x 6192309	 4x 4107765	 2x 371026
 1x 4161326	 4x 6289797	 2x 6411329	 1x 4180533	 6x 6121485	 1x 6102341	 6x 6016172	 2x 6261386	 1x 6040298



1x
4515350



1x
370926



1x
6040297



1x
6179660



2x
300926



1x
366626



1x
6170384



1x
6266626



1x
6286876



1x
6274739



2x
6435020



1x
6252049



22x
6240214



1x
6251289



2x
6207783



4x
6245310



2x
6466832



2x
6289747



2x
6289745



6x
6099728



2x
6003033



2x
6099725



2x
6022078



1x
6421207



4x
6421680



2x
6065504

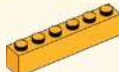

2x
6186542



4x
4211525



1x
6430880



1x
4211475



1x
4211526



2x
6361703



1x
6093527



2x
6262905



2x
4211353



4x
6321747



2x
6273212



2x
4211639



1x
6469669



2x
4211098



2x
6265669



6x
6221607



4x
6350724



1x
6055313



2x
4211095



2x
6083620



2x
6454959



1x
4586410



1x
6284379



1x
6473075



1x
6473071



1x
6469665



1x
6469666



1x
6469667



1x
6469668



1x
6046398



1x
6197967



3x
6070757



1x
6443370



1x
6337410



1x
6471291



4x
6467485

 LEGO.com/service



YOU COULD WIN



Scan this QR code or go to **LEGO.COM/PRODUCTFEEDBACK** and give us your short feedback about this LEGO® set for a chance to win a cool LEGO prize.

Terms and Conditions apply*

EN: YOU COULD WIN. Terms and Conditions apply* **DE: Du könntest GEWINNEN.** Es gelten die Teilnahmebedingungen* **FR: Tu pourrais GAGNER.** Des conditions s'appliquent* **IT: Potresti VINCERE tu.** Termini e condizioni sono applicabili* **ES: Puedes GANAR.** Aplican términos y condiciones* **PT: Poderá GANHAR.** Aplicam-se termos e condições* **ZH: 轻松获奖. 条款和条件适用*** **PL: Szansa na WYGRANĄ.** Obowiązują warunki korzystania* **CS: Máte šanci VYHRÁT.** Platí všeobecné smluvní podmínky* **SK: Máte šancu VYHRAŤ.** Platia všeobecné zmluvné podmienky* **HU: TE IS NYERHETSZ.** Felhasználási feltételek érvényesek* **RO: Ai putea CÂȘTIGA.** Se aplică termenii și condiții* **BG: Можете да СПЕЧЕЛИТЕ.** Има определени правила и условия* **LV: Tu vari LAIMĒT.** Ir spēkā noteikumi un nosacījumi.* **ET: Sul on võimalus VÕITA.** Kehtivad tingimused* **LT: Jūs galite LAIMĖTI.** Taikomos sąlygos*

*[LEGO.com/productfeedback/terms](https://www.lego.com/productfeedback/terms)

LEGO, the LEGO logo and DREAMZzz are trademarks of the LEGO Group. ©2024 The LEGO Group.

6494355