



**SUPER
MARIO**™

71430





LEGO.com/sustainable-packaging



FR
DONNEZ
OU
RECYCLEZ



ASSOCIATION

OU



MAGASIN

OU



DÉCHÈTERIE

Adresses sur quefairedemesdechets.fr

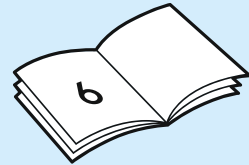
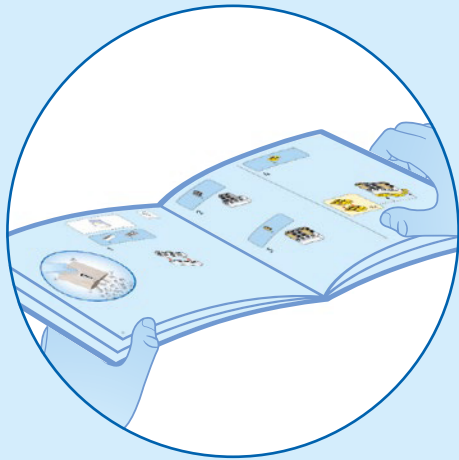
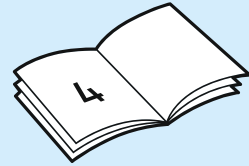
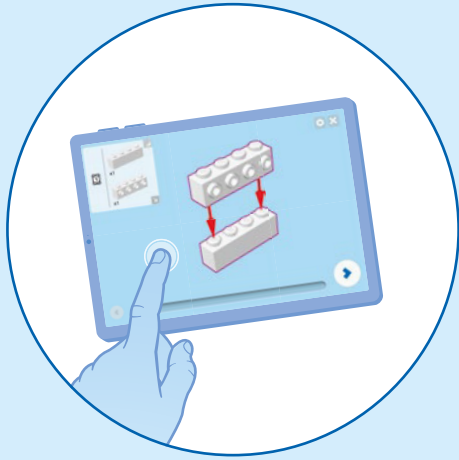



LEGO® Super Mario™ app

1. Scan QR code to build from digital building instruction



1. Scan QR code to build from digital building instruction
2. Open digital building instruction
3. Start building

1. Escanea el código QR para construir con instrucciones de construcción digitales
2. Abre las instrucciones de construcción digitales
3. Empieza a construir

1. Für digitale Bauanleitung den QR-Code scannen
2. Digitale Bauanleitung öffnen
3. Der Bauspaß kann beginnen

1. Lê o código QR para construir utilizando as Instruções de Construção digitais
2. Abrir as instruções de construção digitais
3. Começar a construir

1. Scanne le code QR pour construire avec les instructions de montage numériques
2. Ouvre les instructions de montage numériques
3. Commence à construire

1. 扫描二维码, 在数字拼搭说明的协助下拼搭
2. 打开数字拼搭说明
3. 开始拼搭

1. Scansiona il codice QR per scaricare le istruzioni digitali per costruire
2. Apri le istruzioni digitali per costruire
3. Inizia a costruire

1. Zeskanuj kod QR, aby budować dzięki cyfrowym instrukcjom budowania
2. Otwórz cyfrową instrukcję budowania
3. Rozpocznij budowanie

2. Open digital building instruction

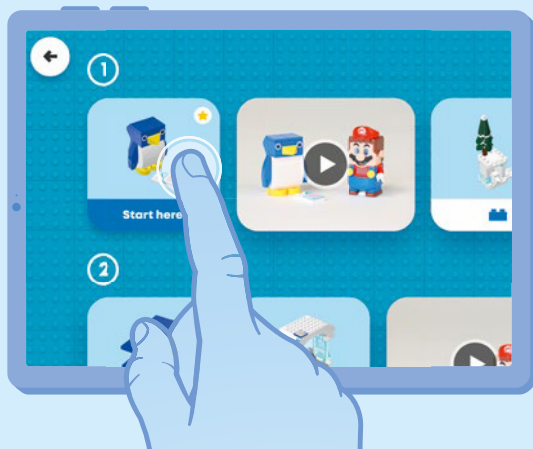

1. Naskenujte QR kód a stavte podle digitálního návodu
2. Otevřete digitální návod na stavění
3. Pusťte se do stavění

1. Сканирайте QR кода, за да започнете строите с цифрови инструкции за построяване
2. Отворете цифровите инструкции за построяване
3. Започнете да строите

1. Naskenujte QR kód a stavajte podľa digitálneho návodu
2. Otvorte digitálny návod na stavanie
3. Pusťte sa do stavania

1. Skenē QR kodu, lai būvētu, izmantojot digitālas būvēšanas instrukcijas
2. Atver digitālo būvēšanas instrukciju
3. Sākt būvēt

3. Start building

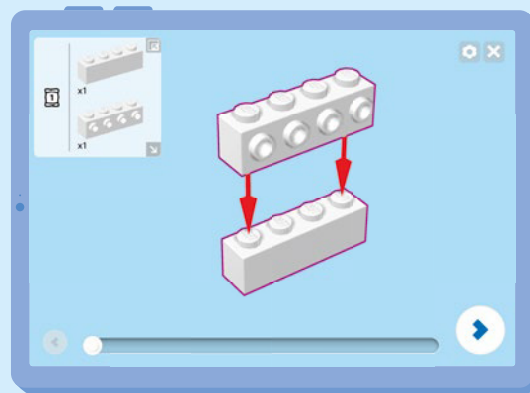

1. Olvasd be a QR-kódot a digitális építési útmutató használatához!
2. Digitális építési útmutató megnyitása
3. Kezdődjön az építés!

1. Skanni QR-kood, et ehitada digitaalsete ehitusjuhiste
2. Ava digitaalsed ehitusjuhised
3. Alusta ehitamist

1. Scanează codul QR pentru a construi pe baza instrucțiunilor digitale
2. Deschide instrucțiunile de construcție digitale
3. Începe să construiești

1. Nuskaitykite QR kodą ir konstruokite naudodamiesi instrukcijomis
2. Atidarykite skaitmenines instrukcijas
3. Konstruokite

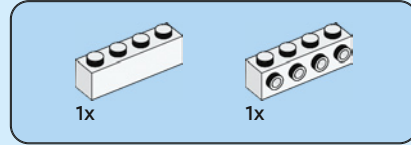
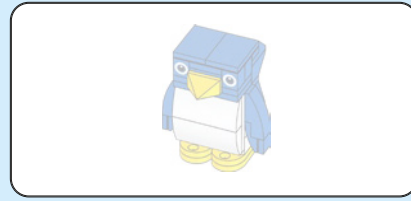

1

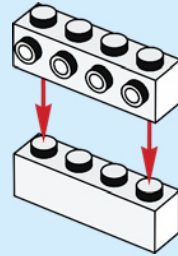



1x

2

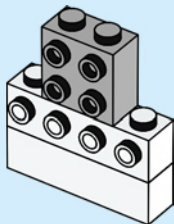

2x

3

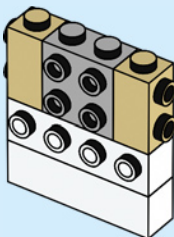

4x

4

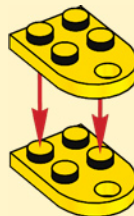

2x

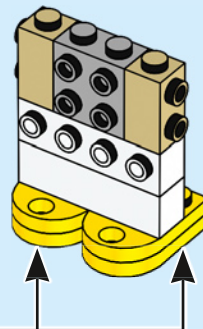

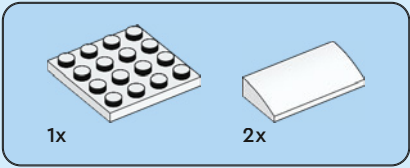

5

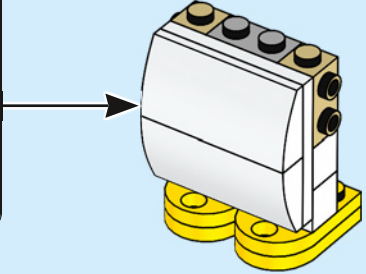
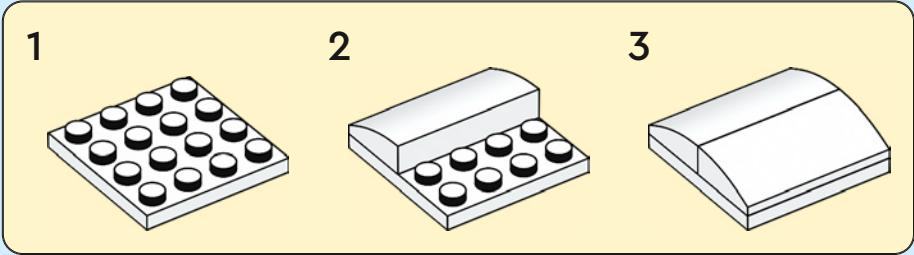

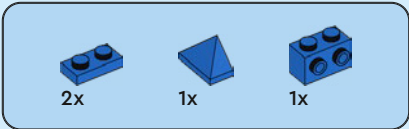

6

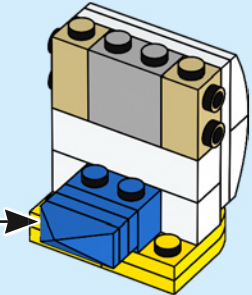
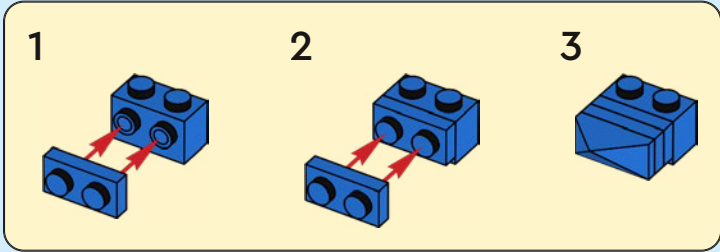



2x

7

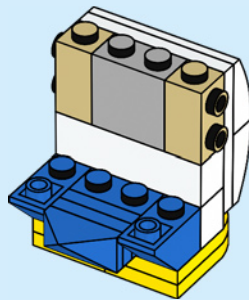

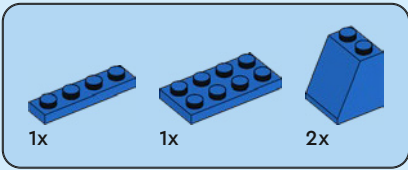

8

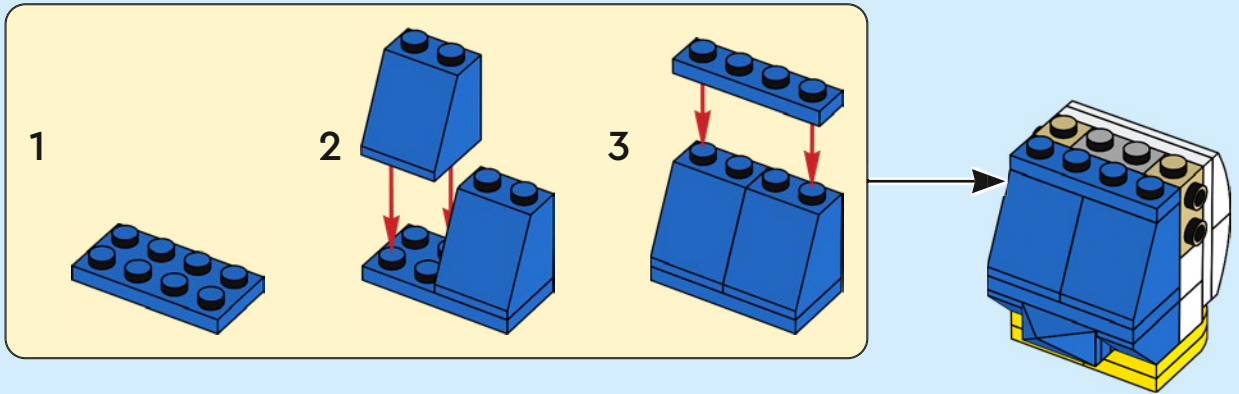

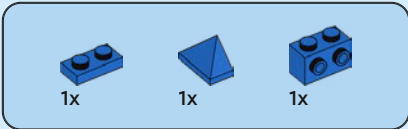

9

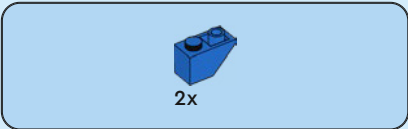
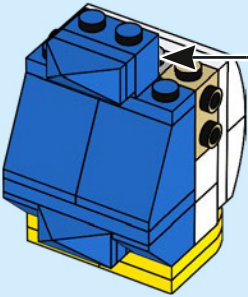
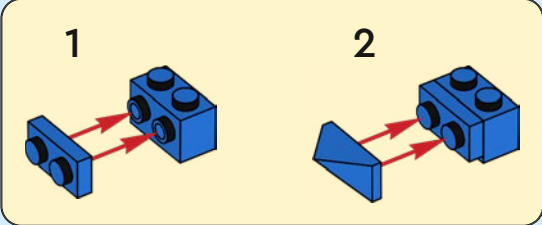

10

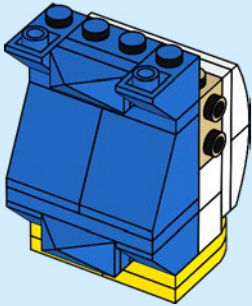

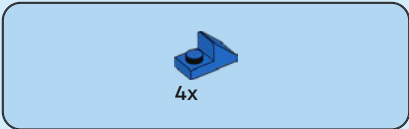

11

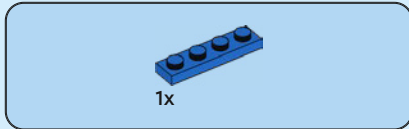
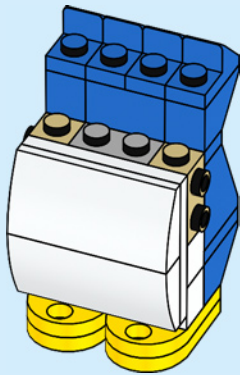

12

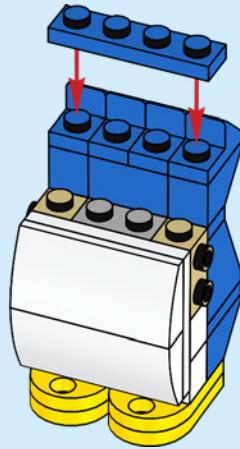

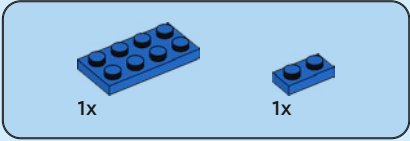

13

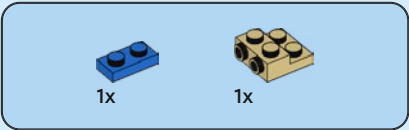
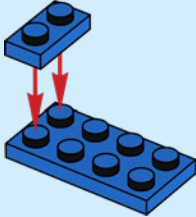

14

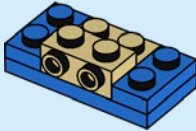

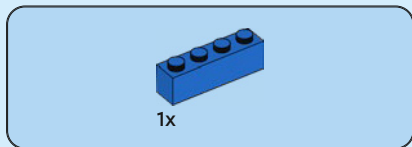

15

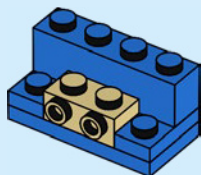

16

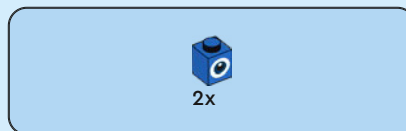
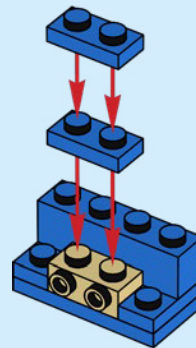

17

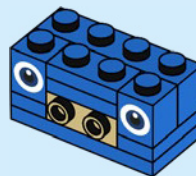

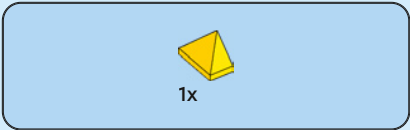

18

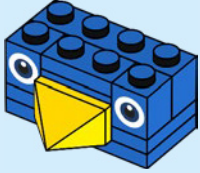

19

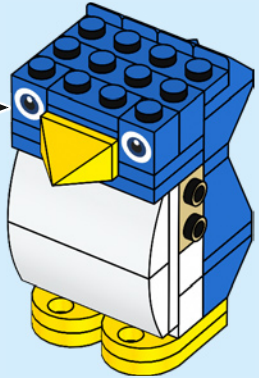

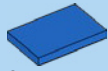

2x

20

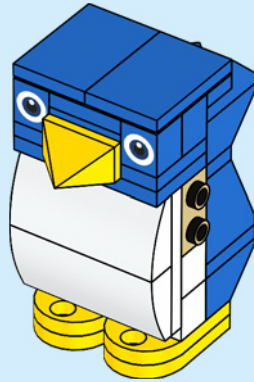



21

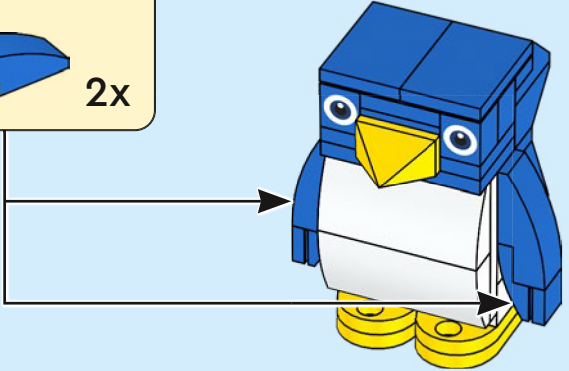
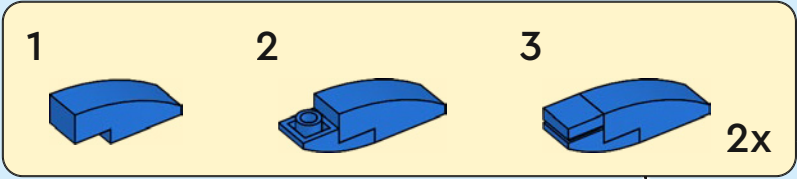

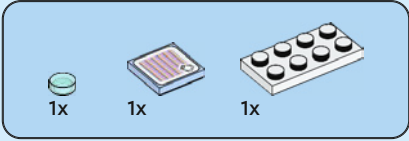

1

1

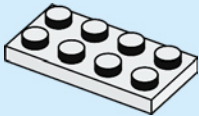

2

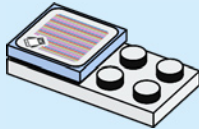

3

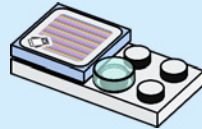

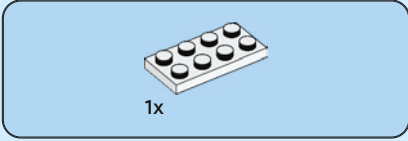
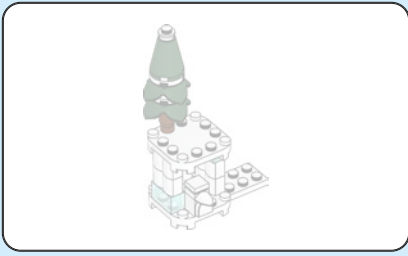

1

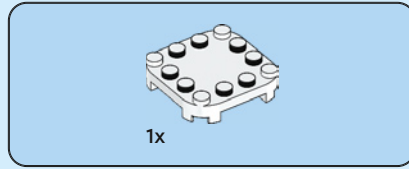
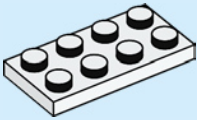

2

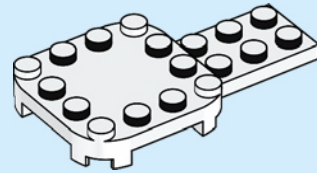



3x

3

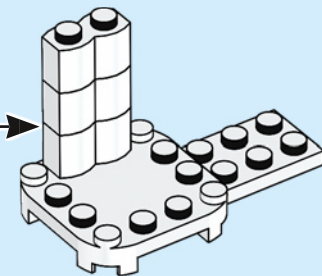
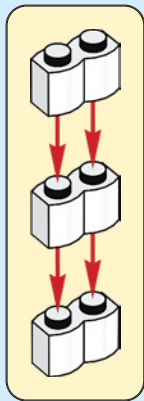

2x



1x

4

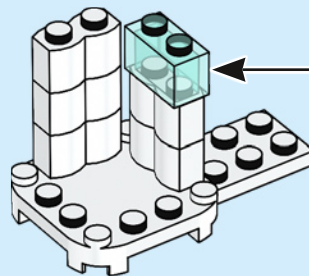
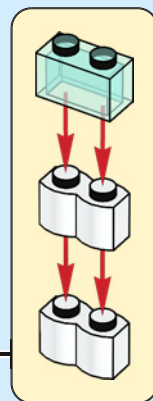



2x



1x

5

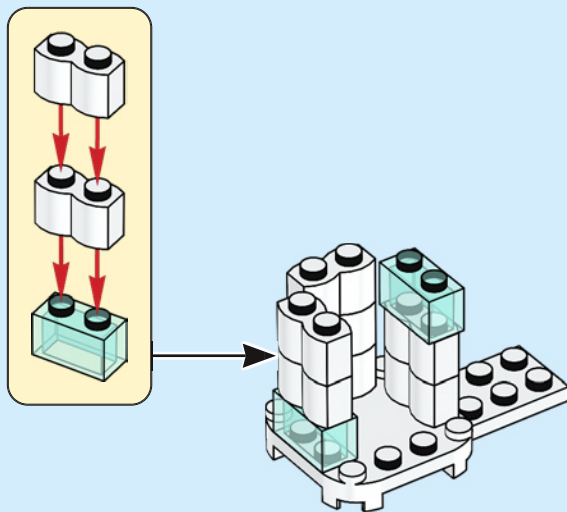

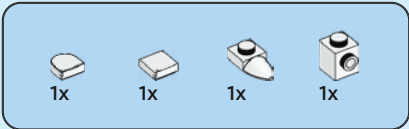

6

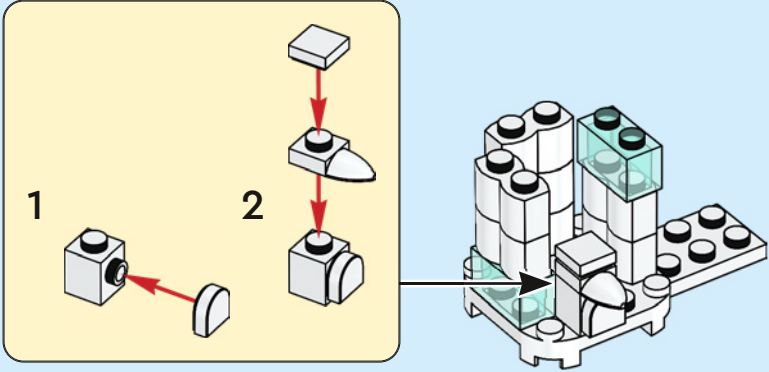

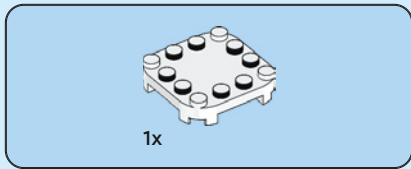

7

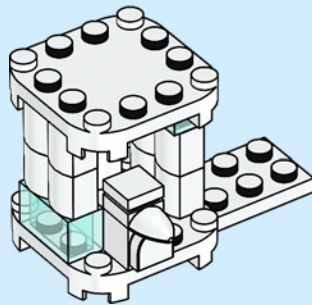



8



9





1x

10



1x

11



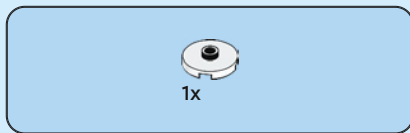

12



13





1x

14



15

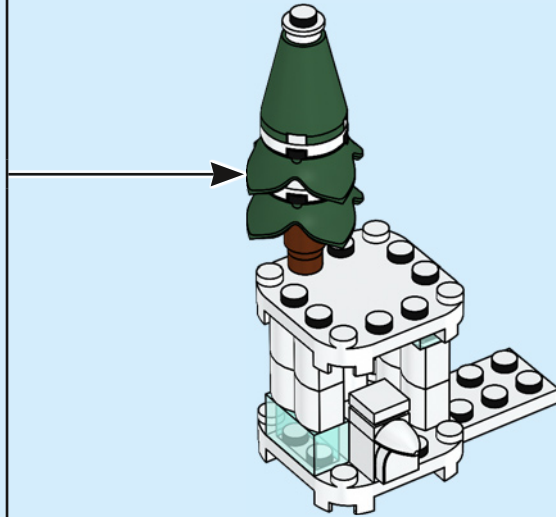

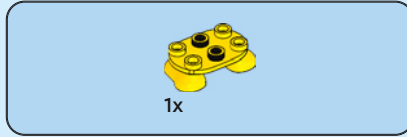

1



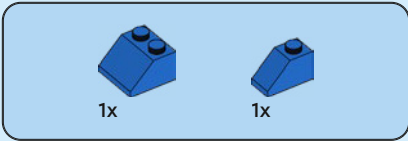

2

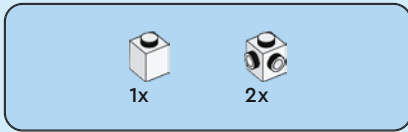
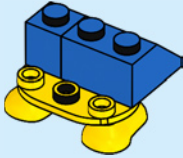

3

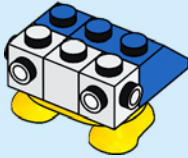



4

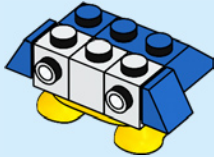

5

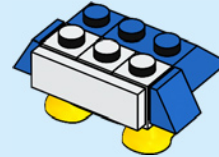

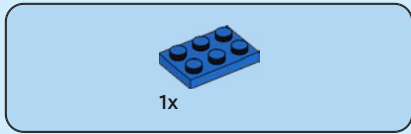

6

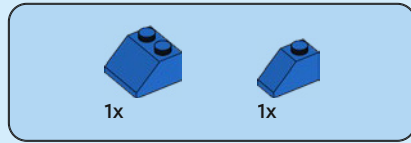
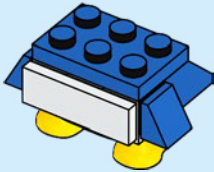

7

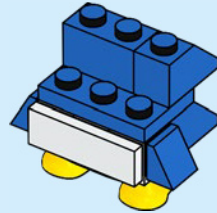



1x



2x

8

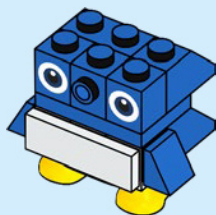

1x



1x

9



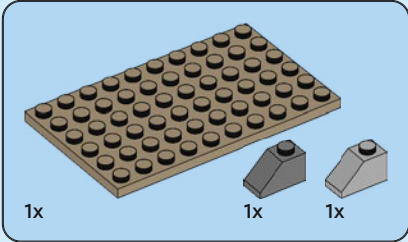
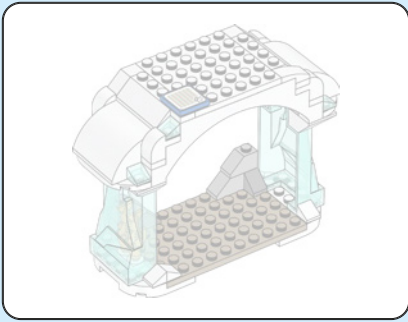

1

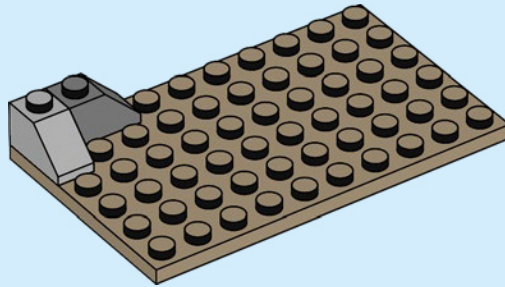

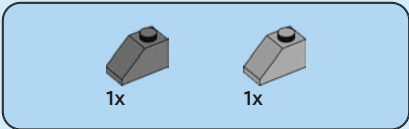

2

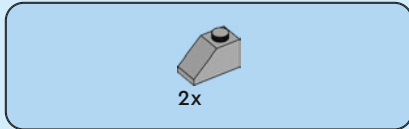
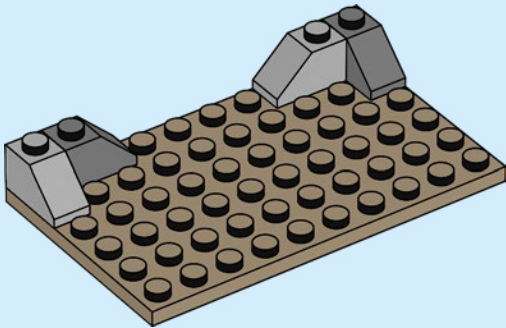

3

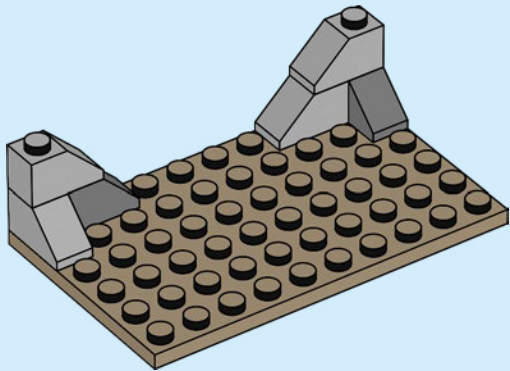

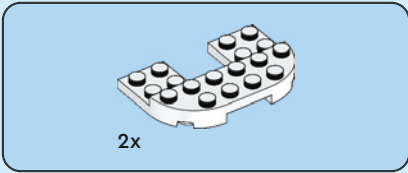

4

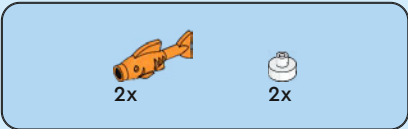
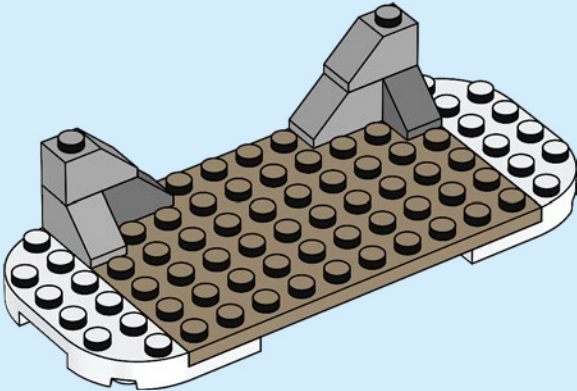

5

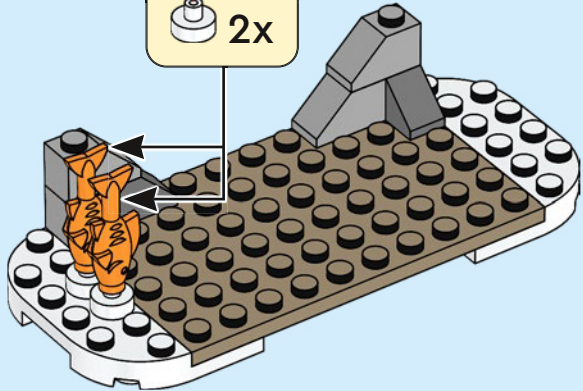
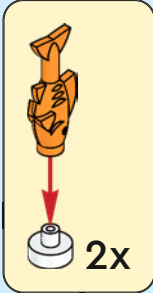



3x

6

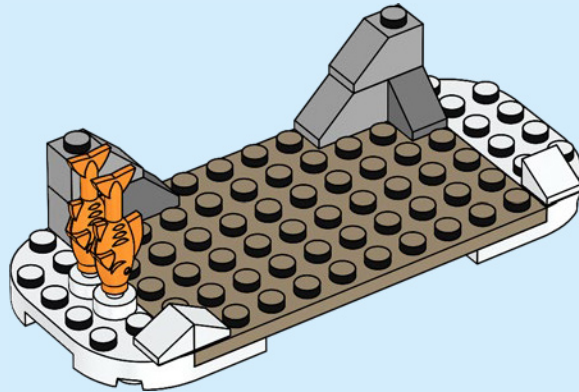

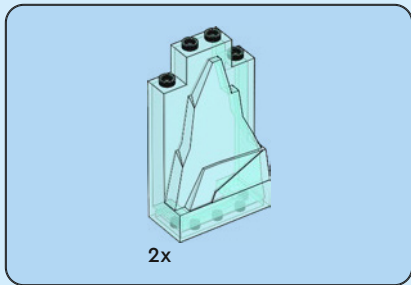

7

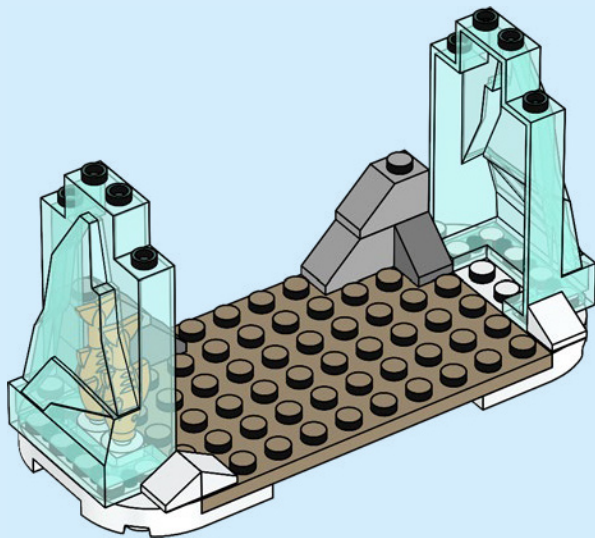



4x

8

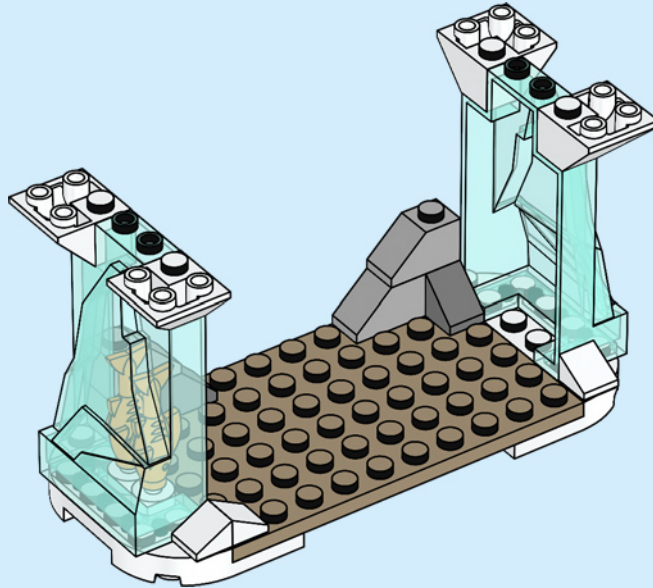



2x

9

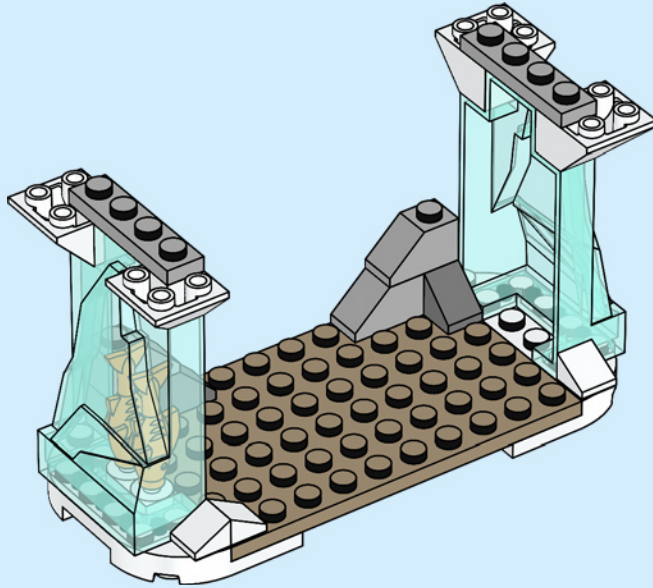



2x

10

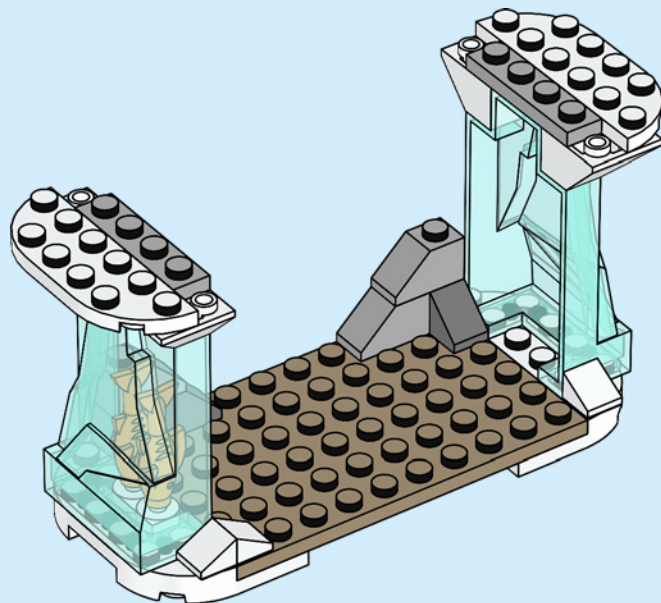

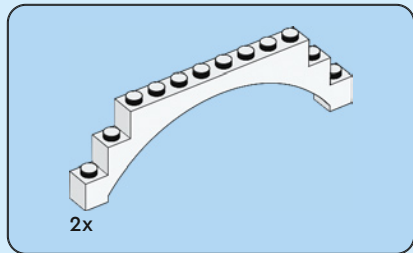

11

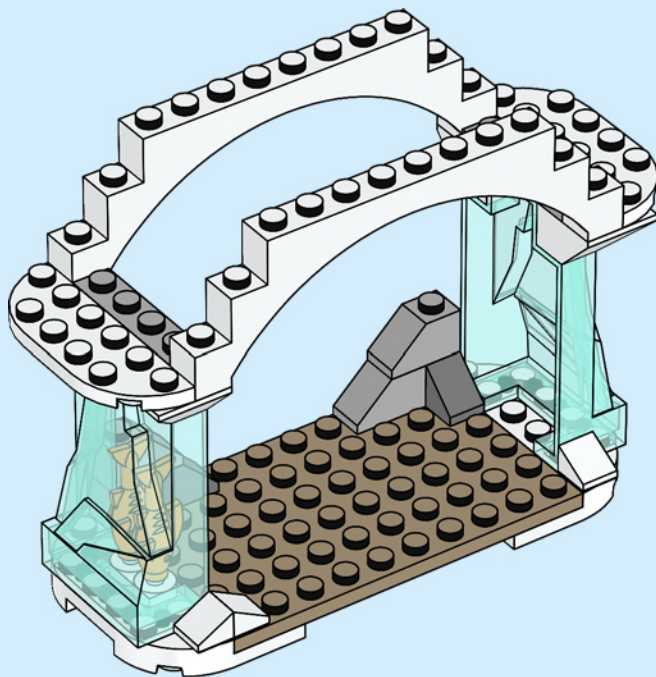

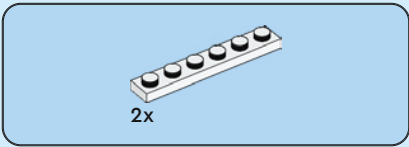

12

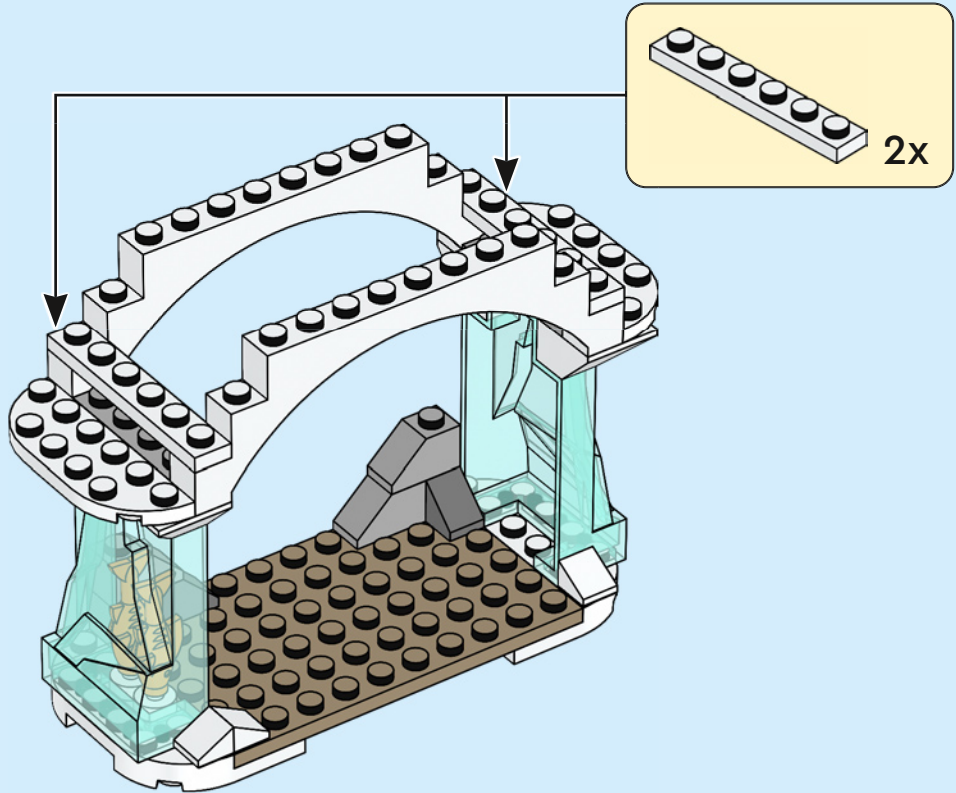



2x

13

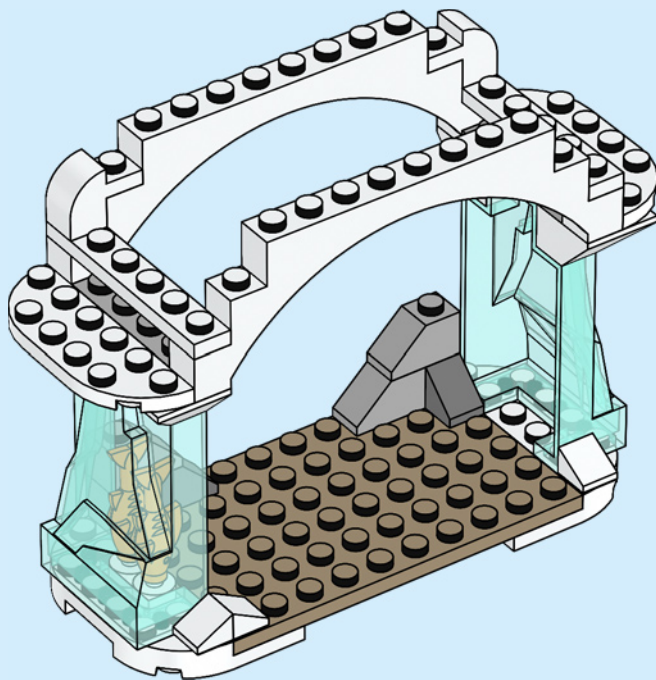



2x

14

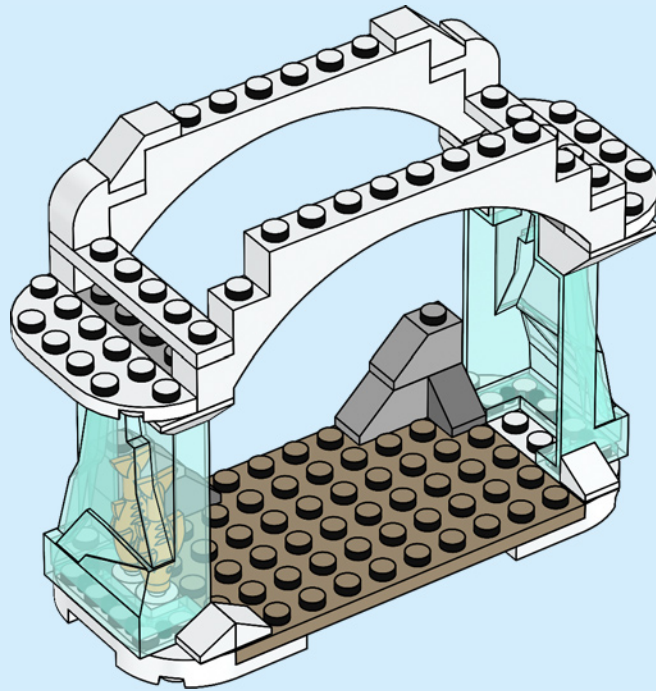

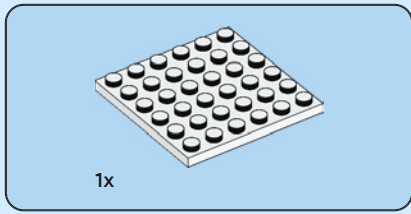

15

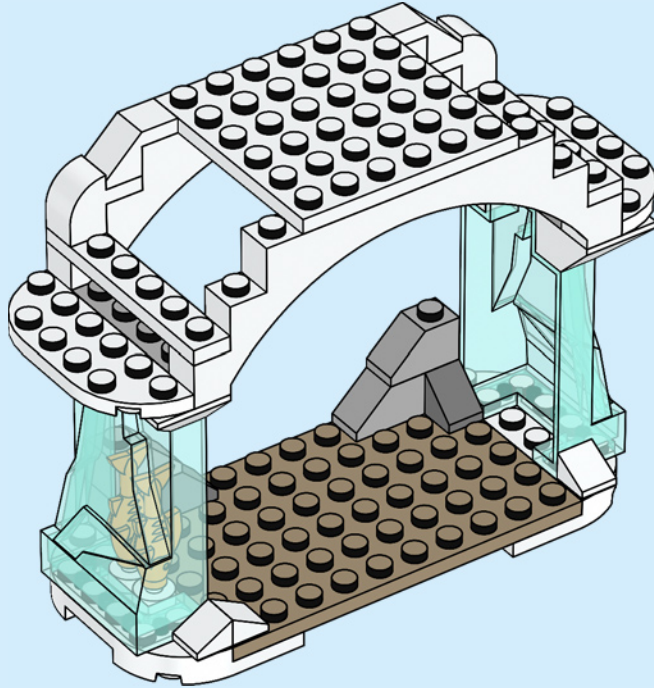

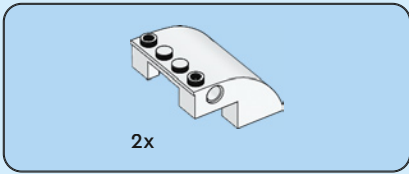

16

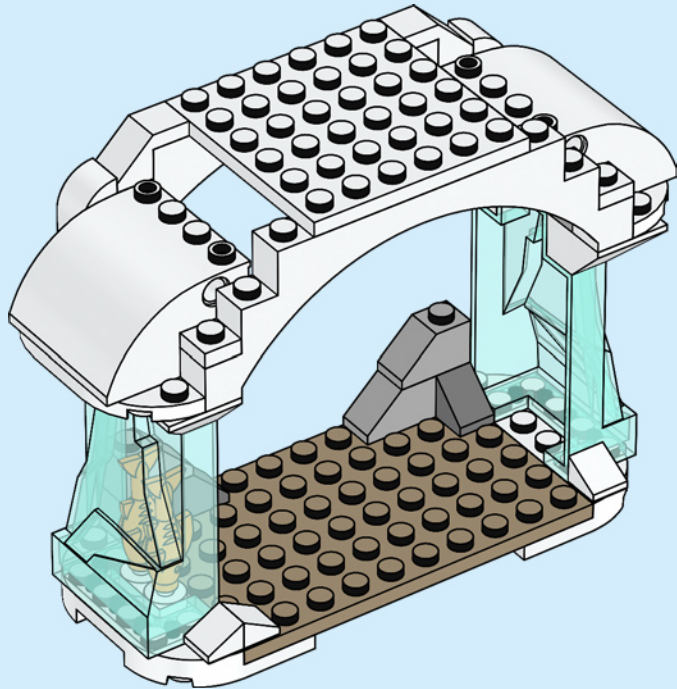

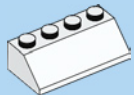

2x

17

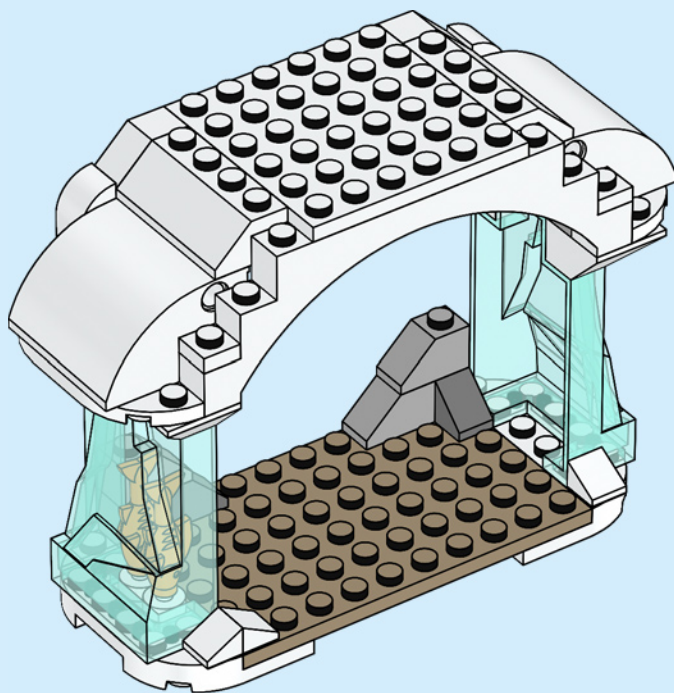



1x



2x

18

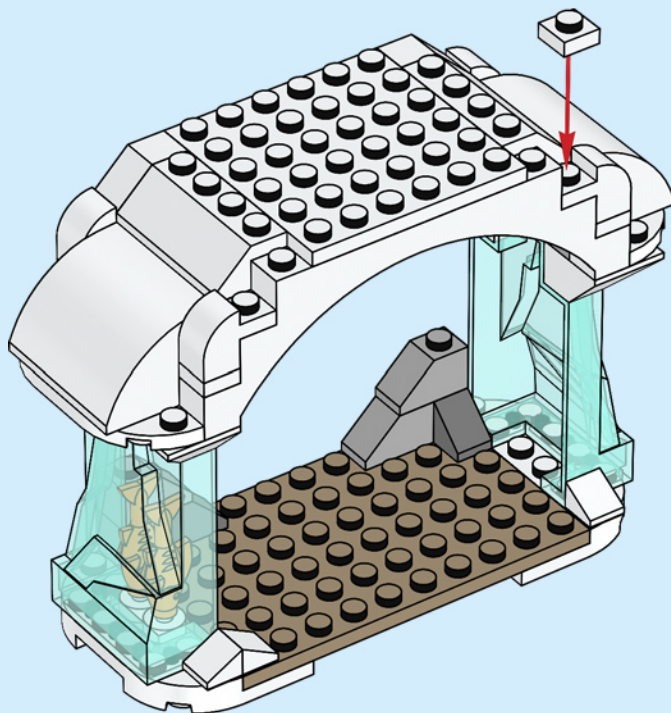



3x

19



3x

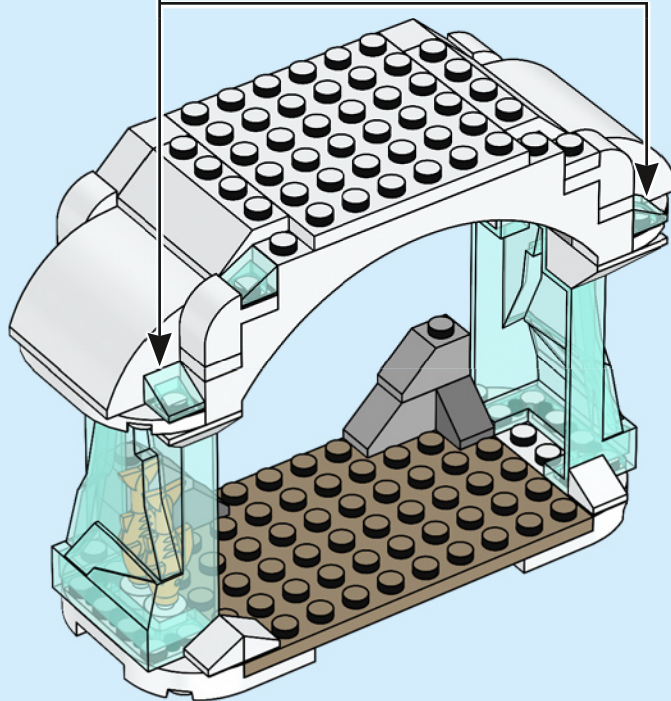



1x



1x

20

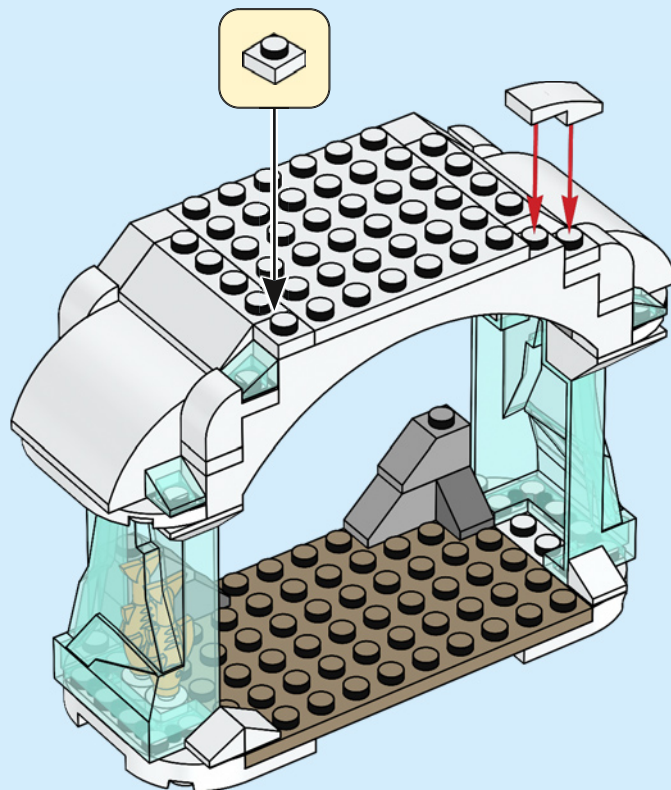



1x

21

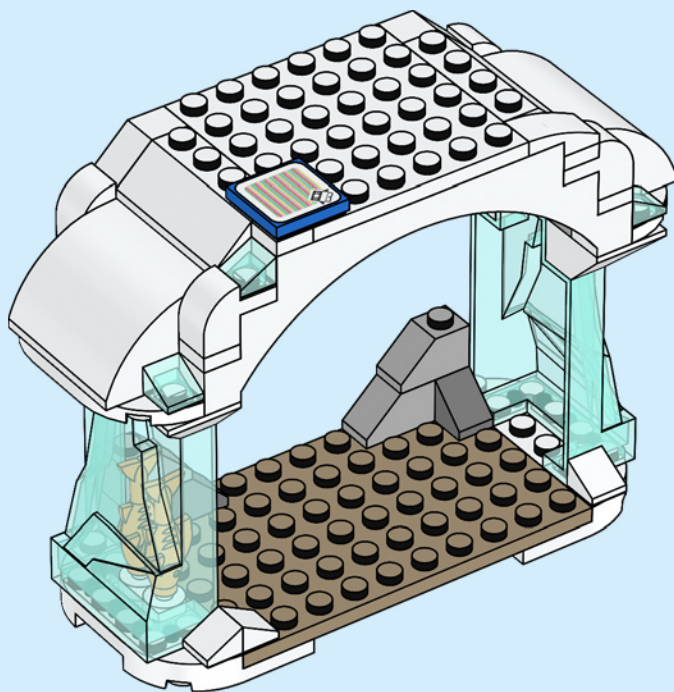



1





2x

2



1x

3



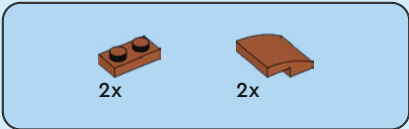

4

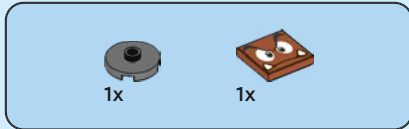
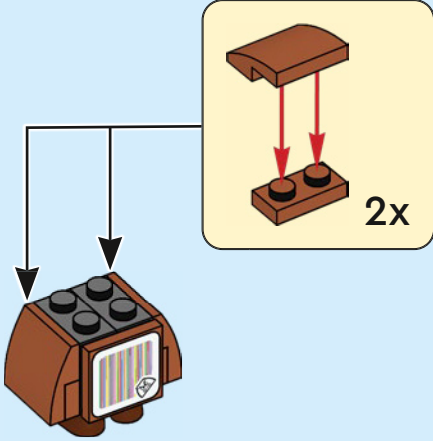

5

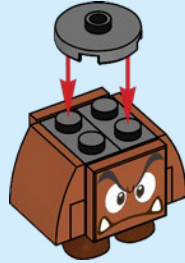

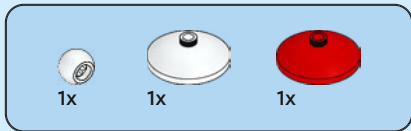

6

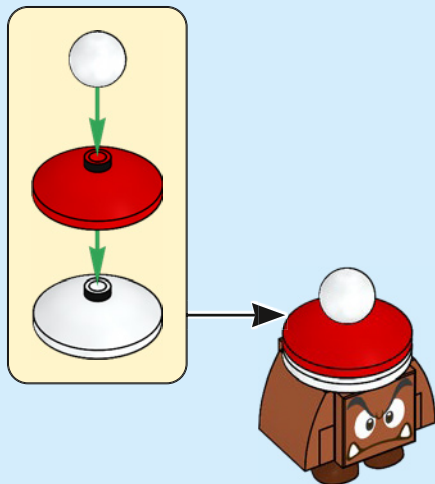

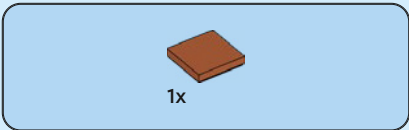

7

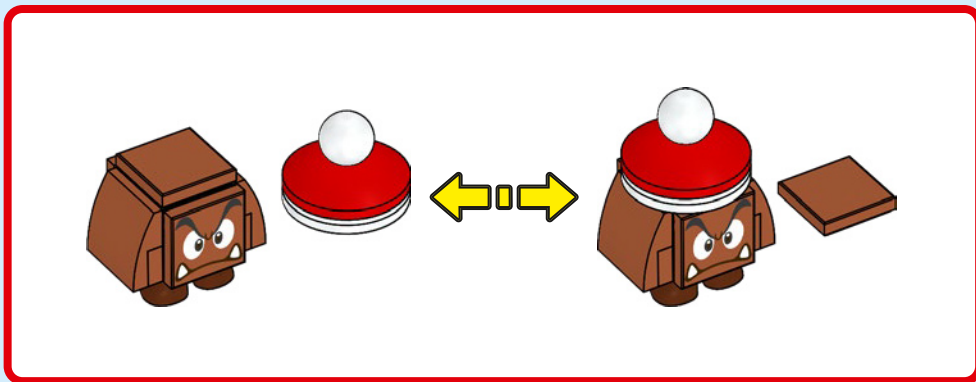

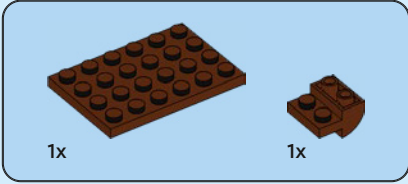
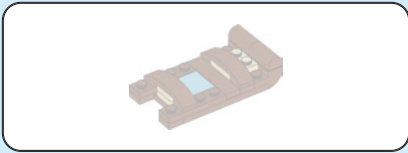

1

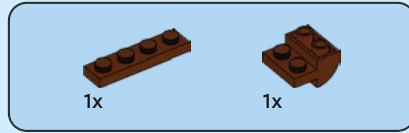
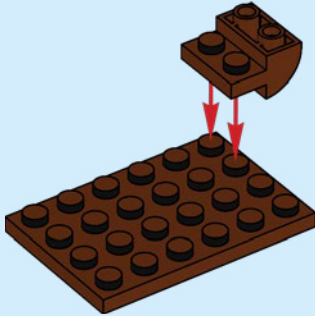

2

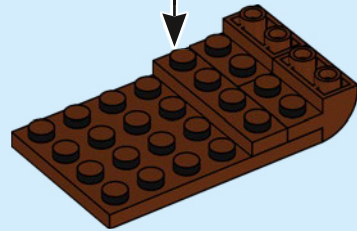
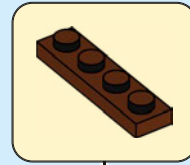

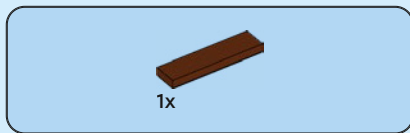

3

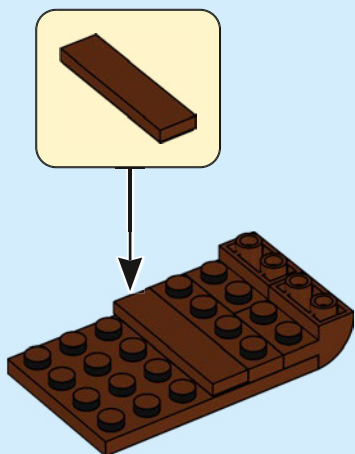

4

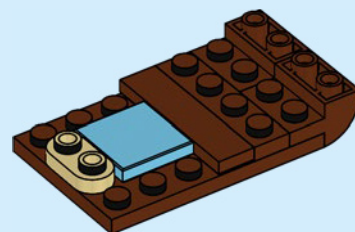



5

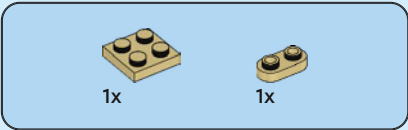
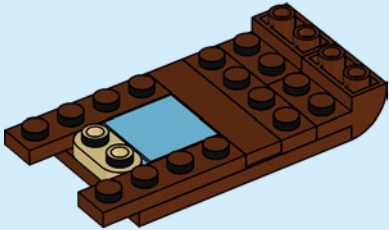

6

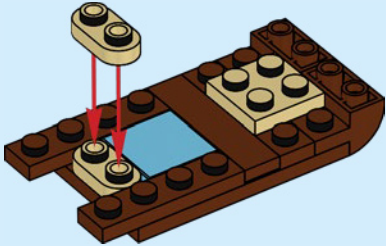



7

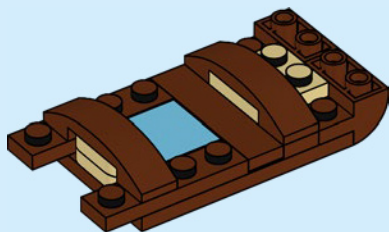

8

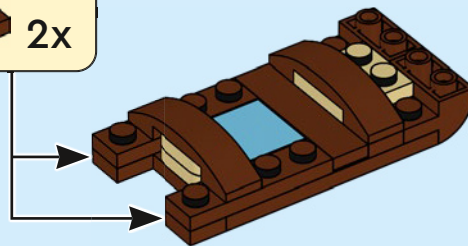

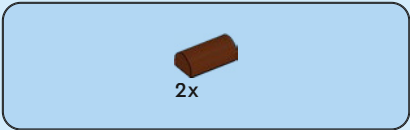

9

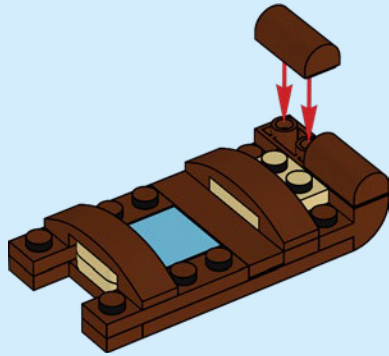

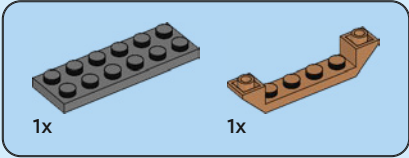
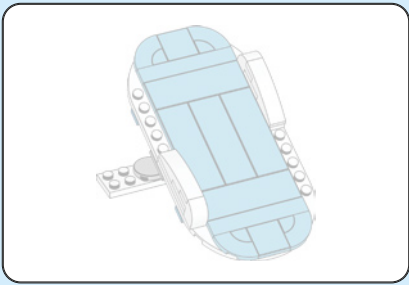

1

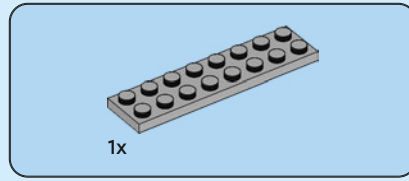
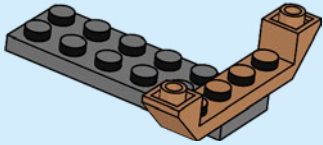

2

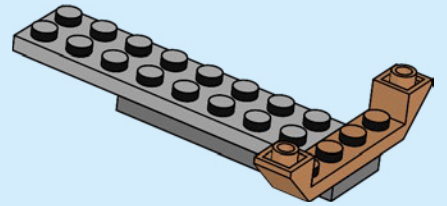

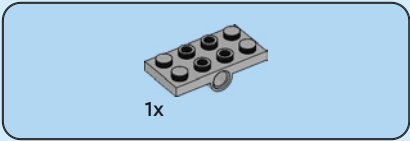

3

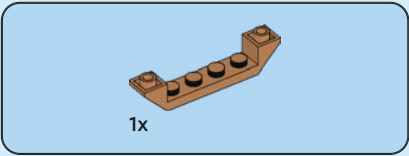
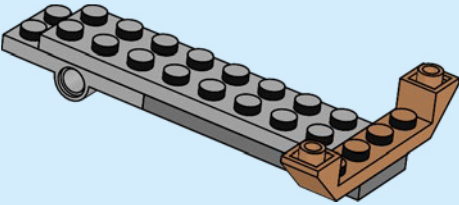

4

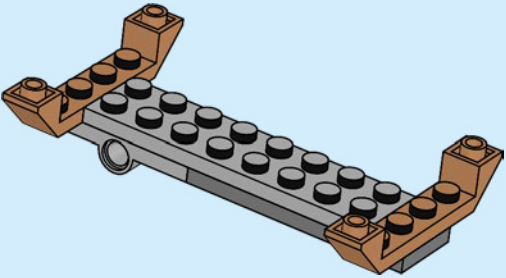

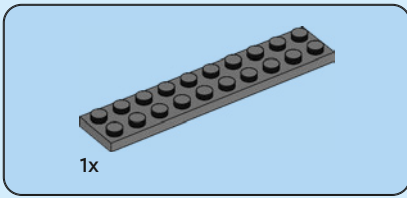

5

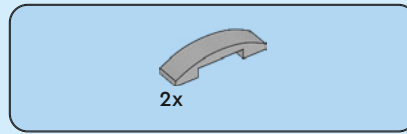
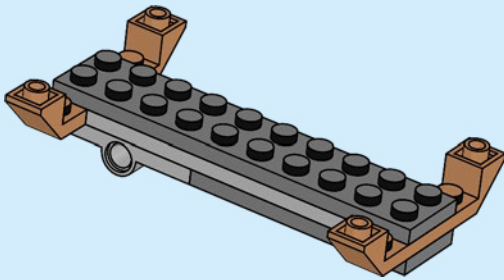

6

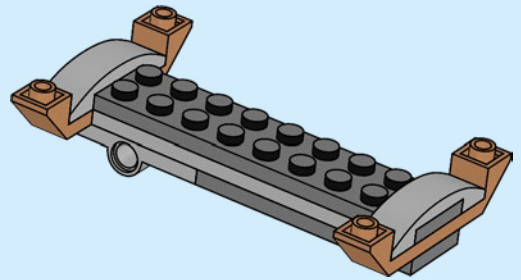

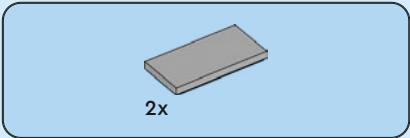

7

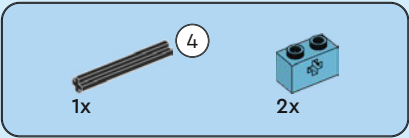
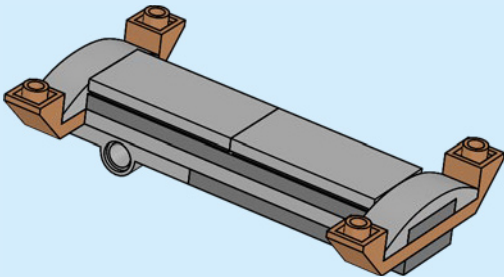

8

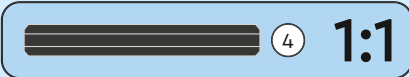
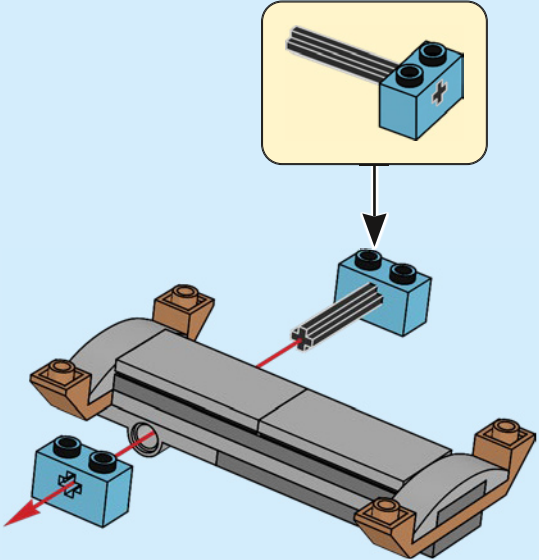

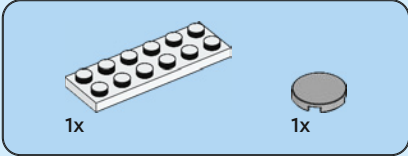
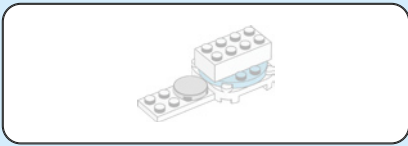

9

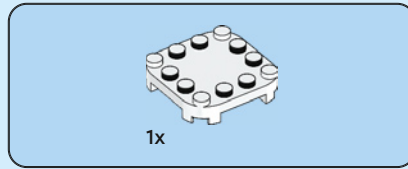
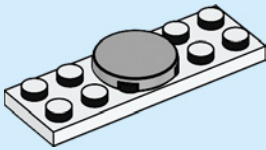

10

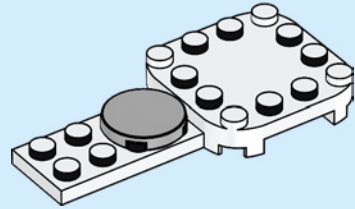

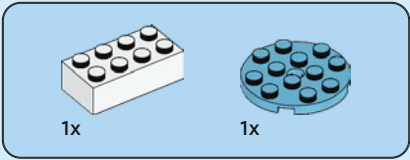

11

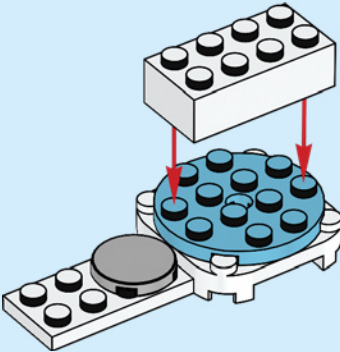

12

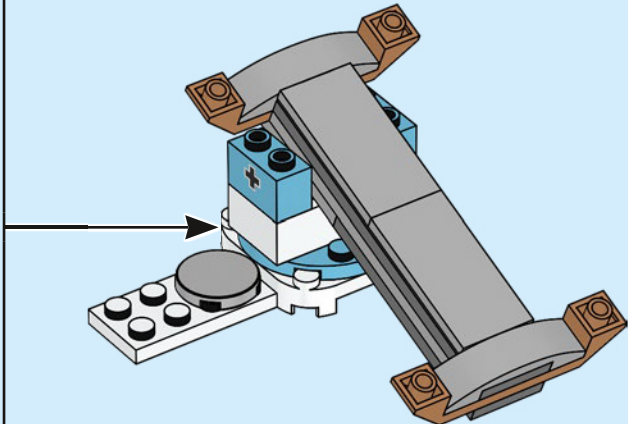

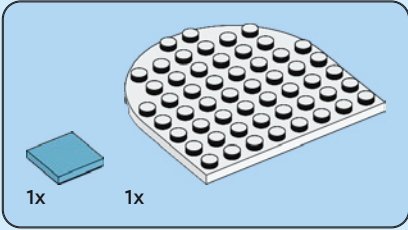
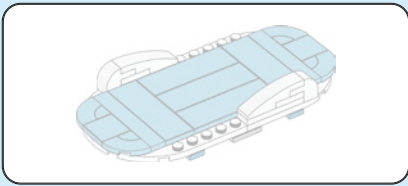

1

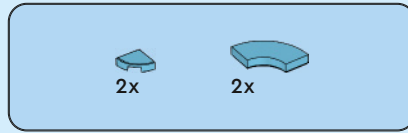
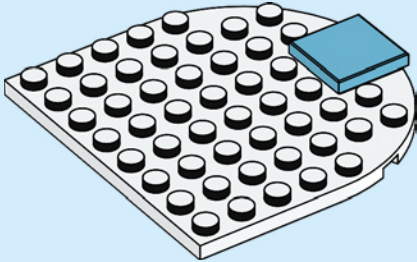

2

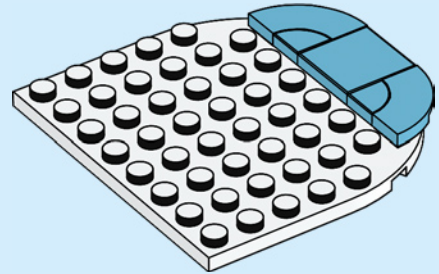

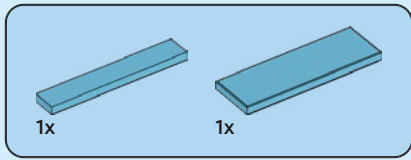

3

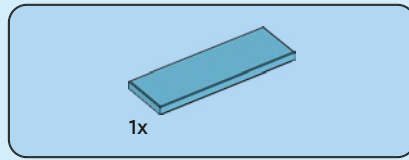
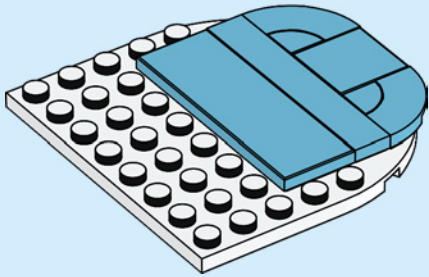

4

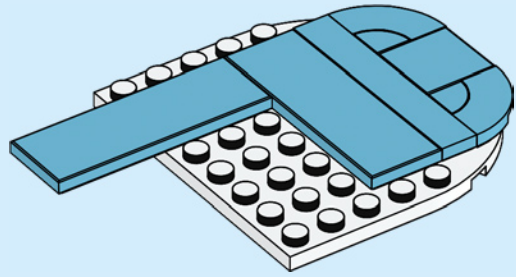

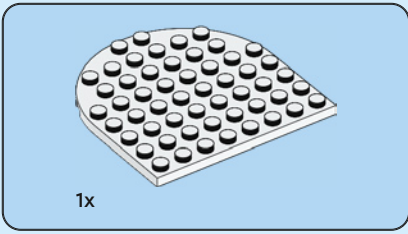

5

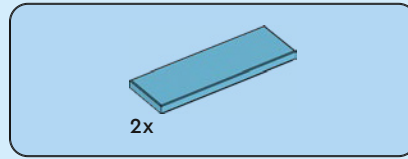
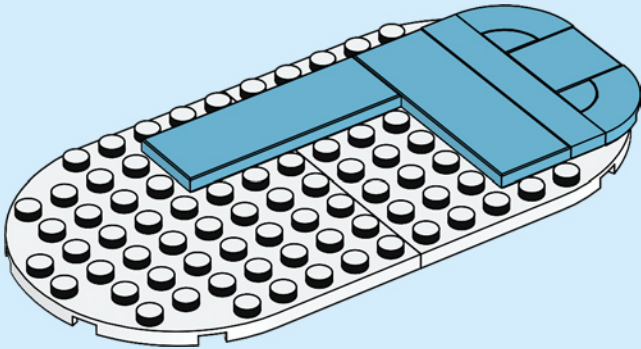

6

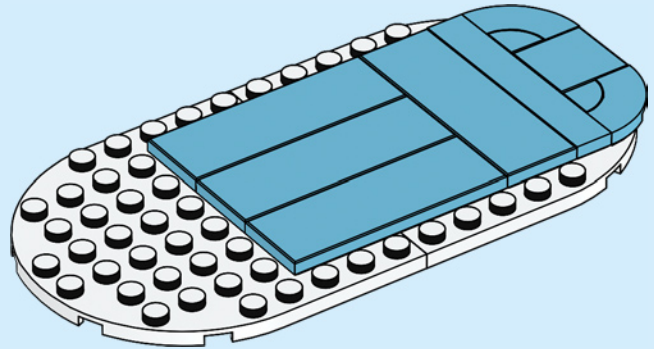

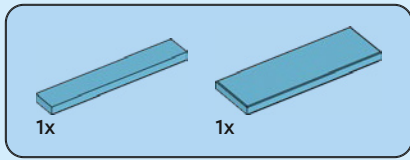

7

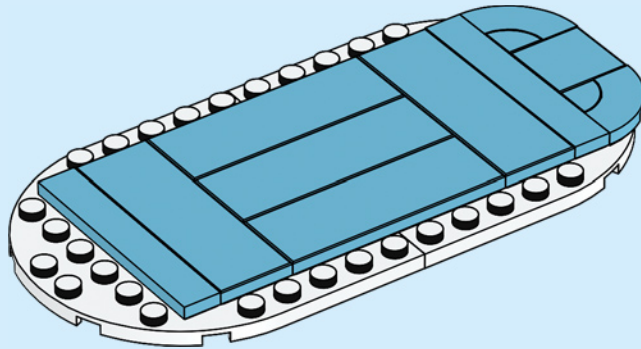

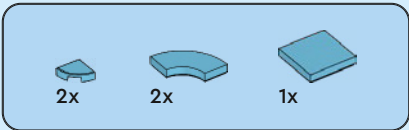

8

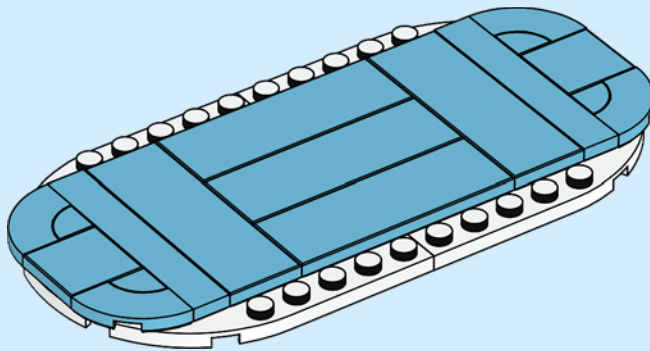



2x

9

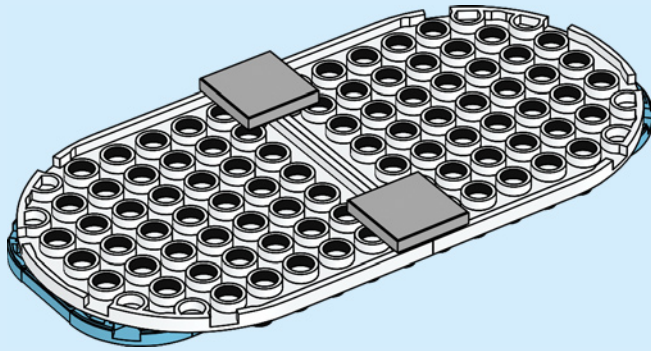



4x



4x

10

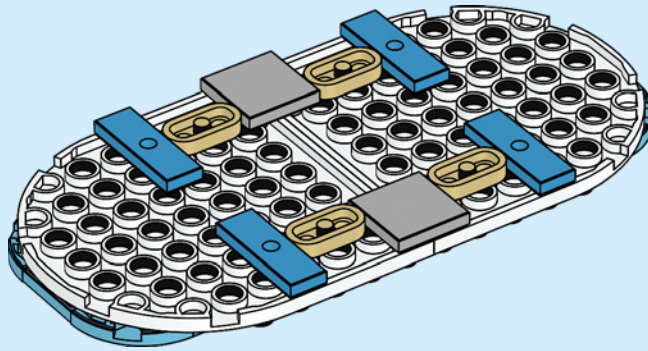

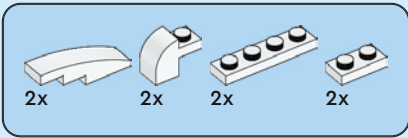

11

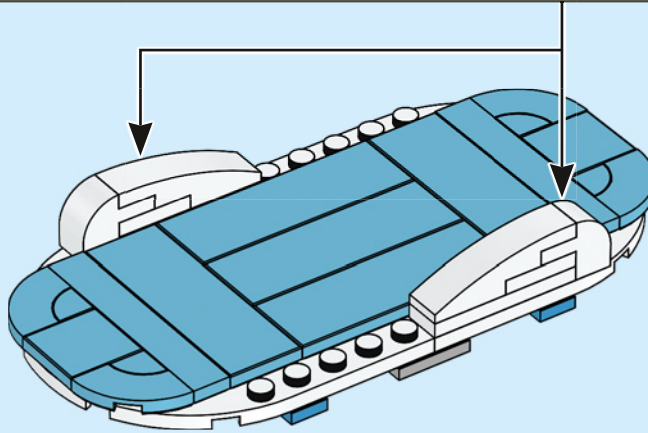
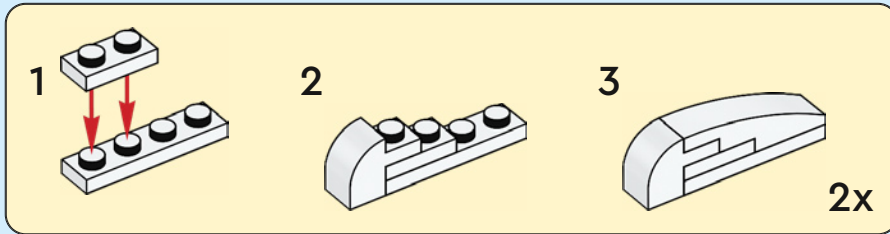

12

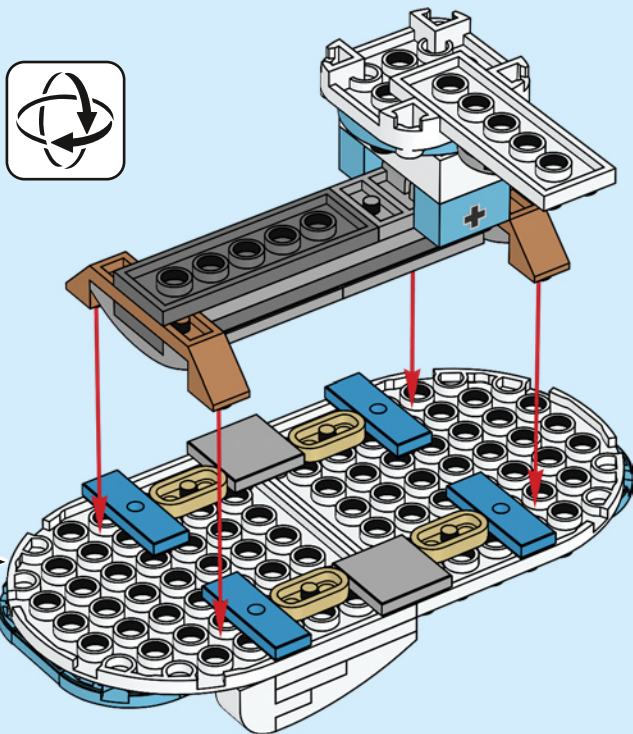

13

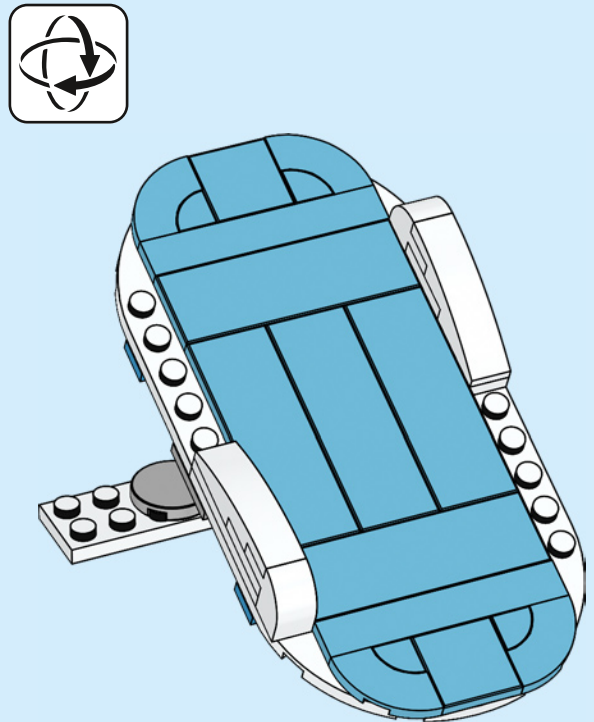

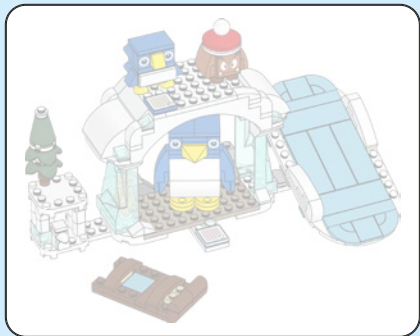

1

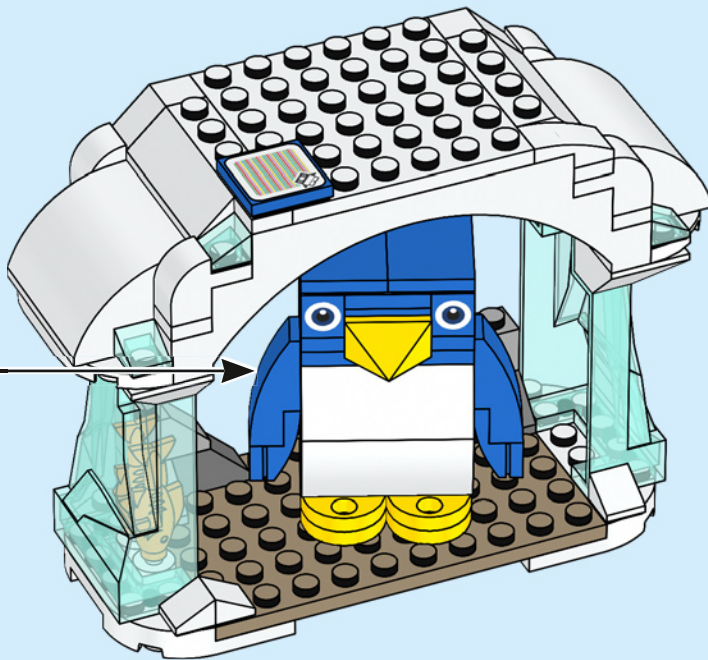
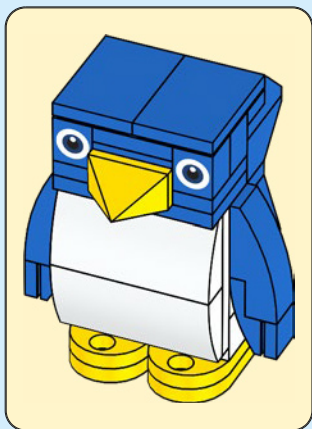

2

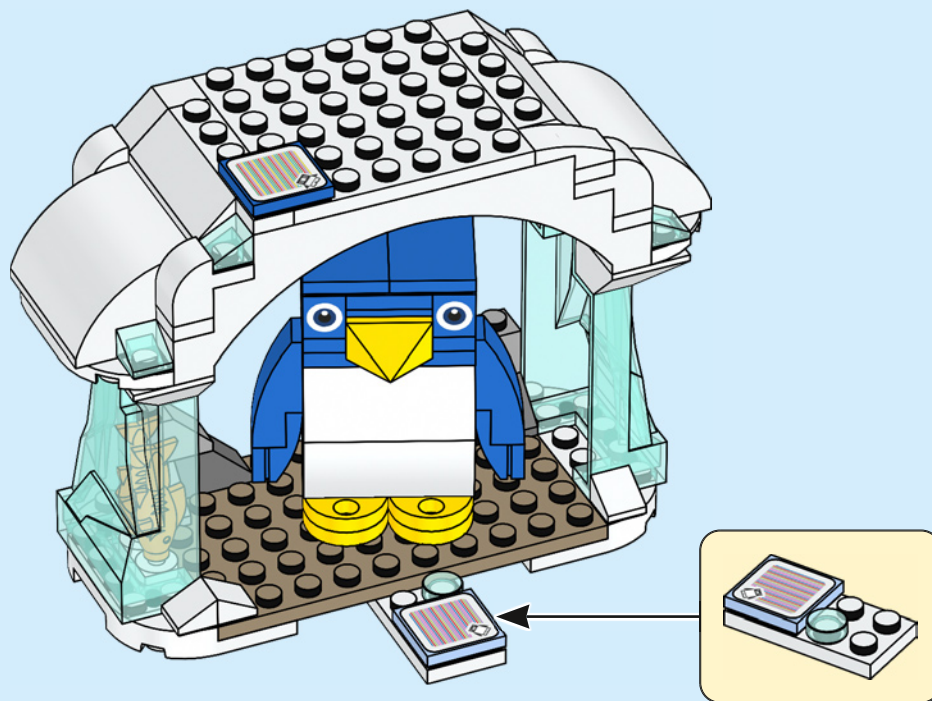

3

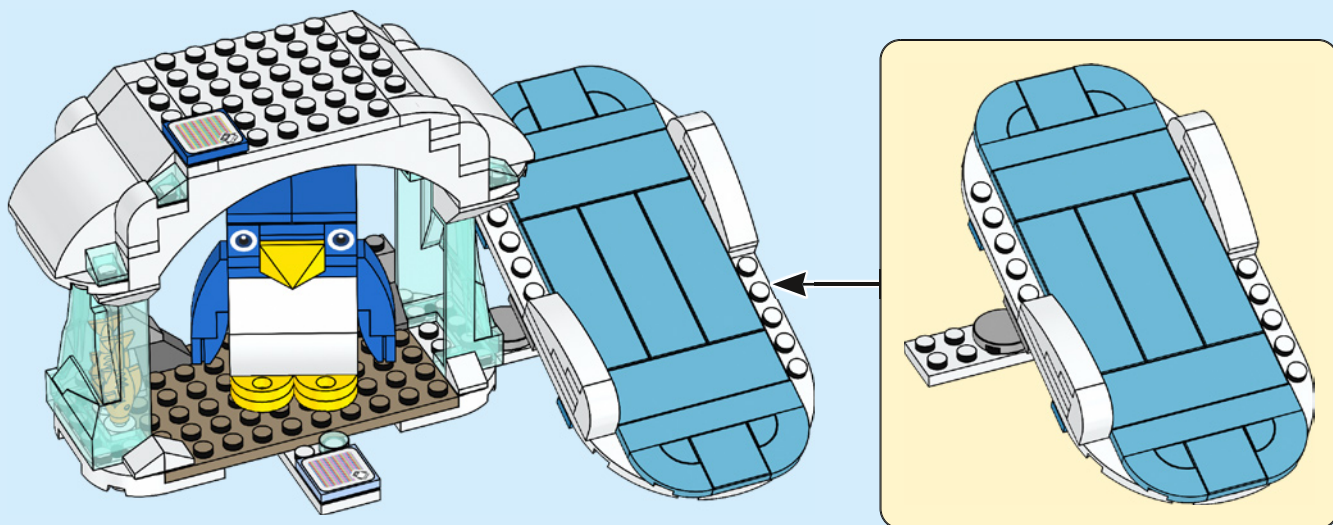

4

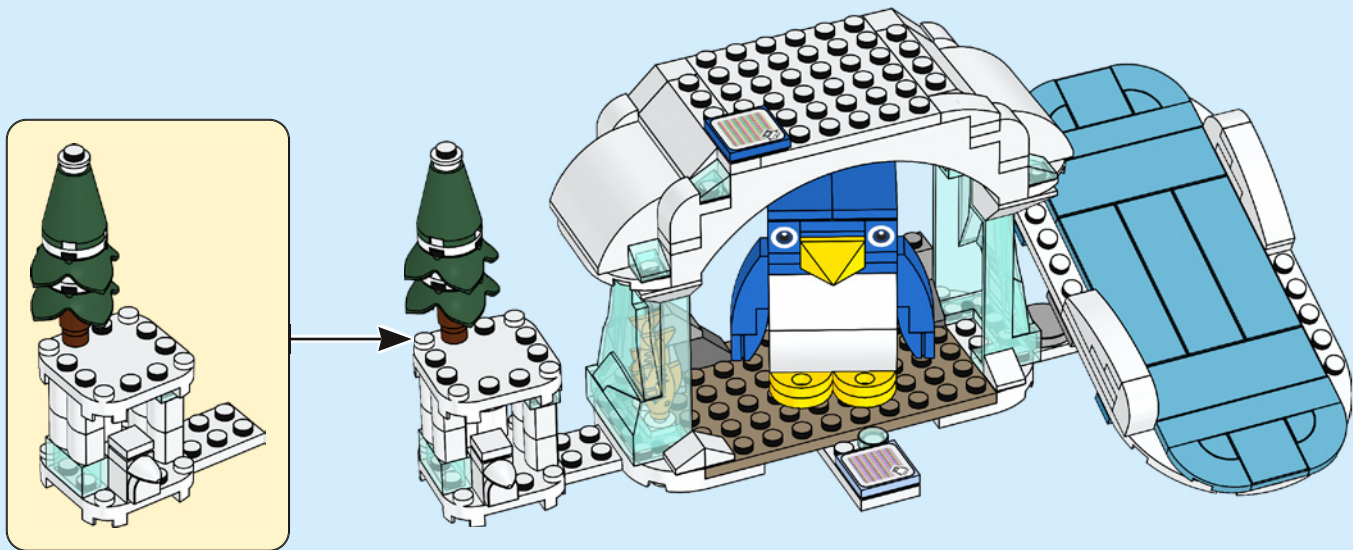

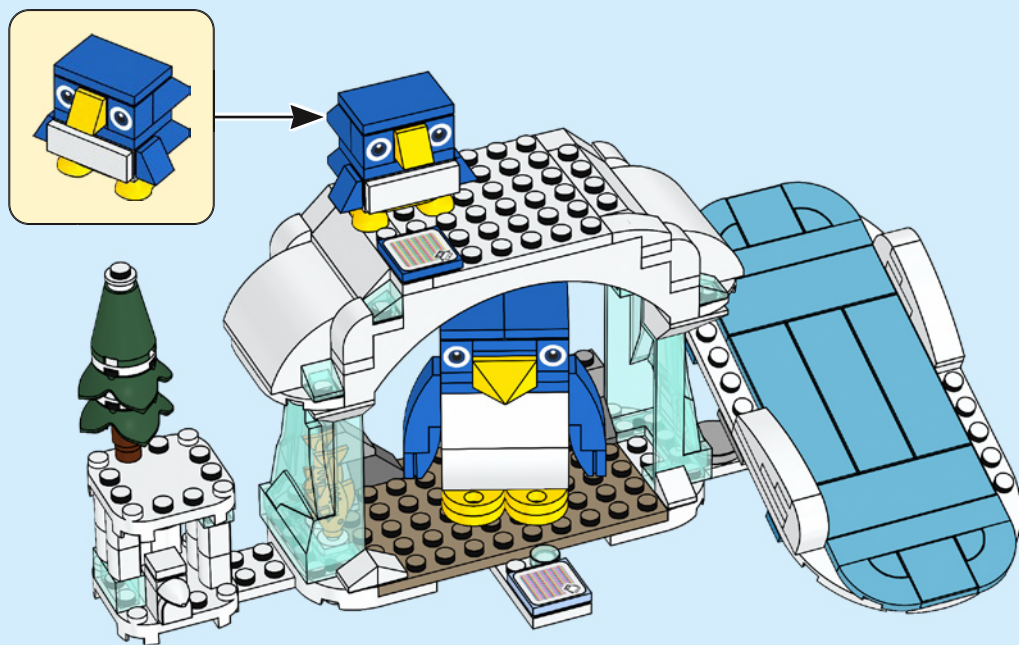

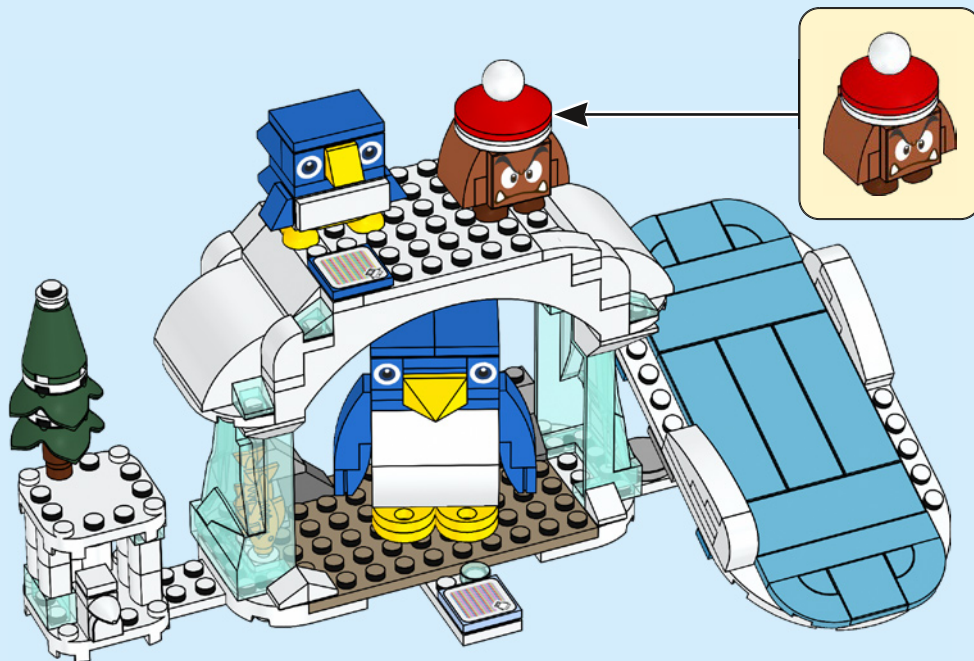

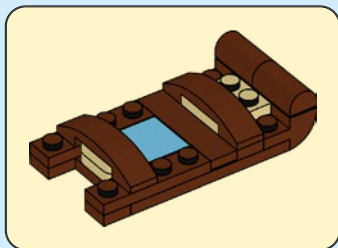
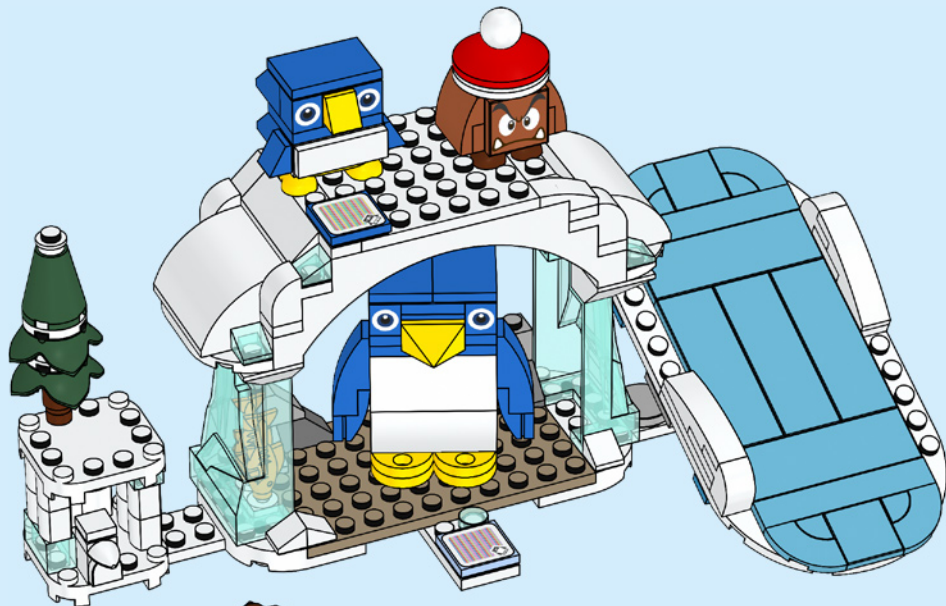

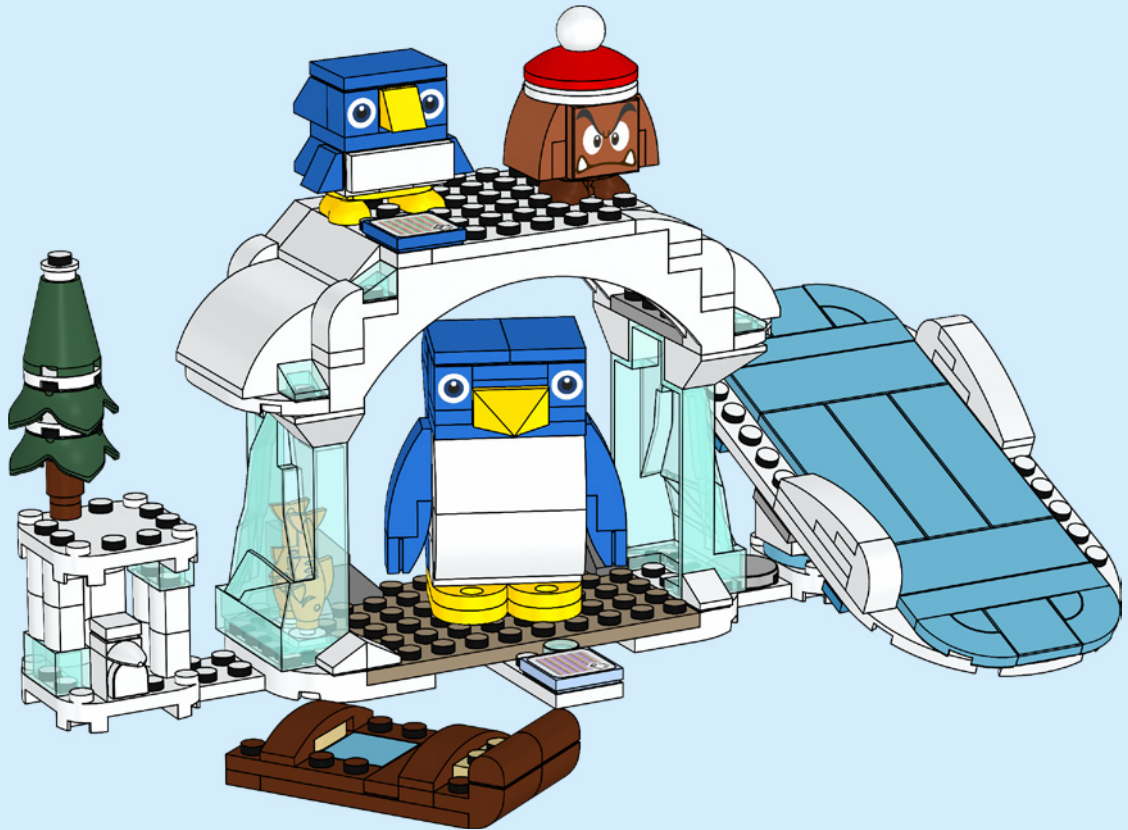

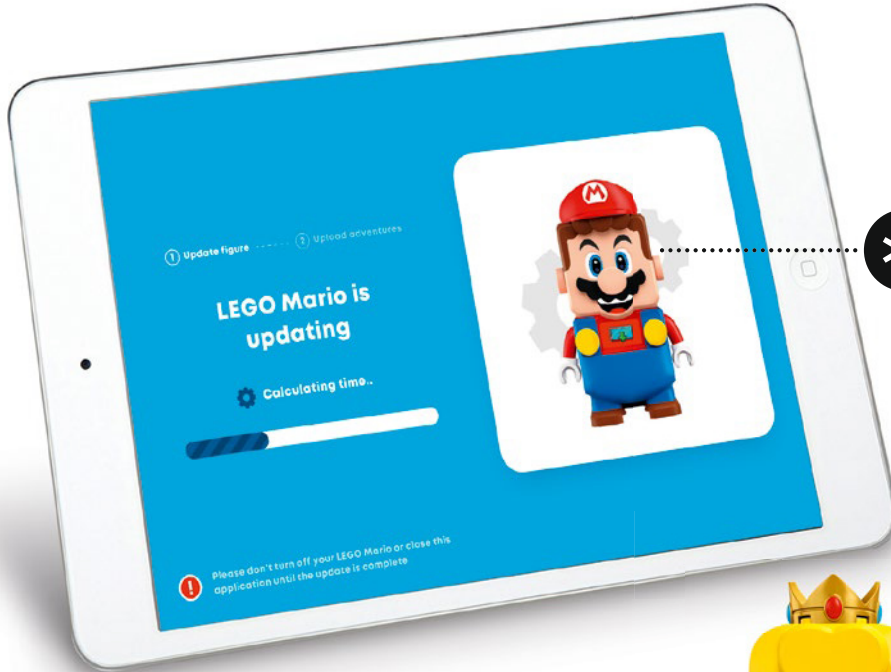

**UPDATE YOUR
INTERACTIVE FIGURE
IN THE LEGO®
SUPER MARIO™ APP TO
BE READY TO PLAY**

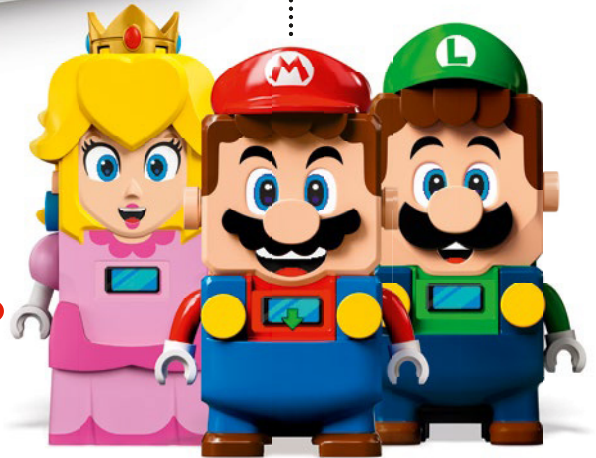

Update your interactive figure in the LEGO® Super Mario™ app to be ready to play

Aktualisiere deine interaktive Figur in der LEGO® Super Mario™ App und das Spiel kann beginnen

Mets à jour ta figurine interactive dans l'appli LEGO® Super Mario™ avant de jouer

Aggiorna il tuo personaggio interattivo nell'app LEGO® Super Mario™ perché sia pronto per giocare

Actualiza tu figura interactiva en la app LEGO® Super Mario™ y prepárate para jugar

Atualiza a tua figura interativa na aplicação LEGO® Super Mario™ para começar a jogar

在乐高®超级马力欧应用程序中更新你的交互式人偶，为玩乐做好准备

Zaktualizuj swoją interaktywną figurkę w aplikacji LEGO® Super Mario™, aby przygotować ją do zabawy

Aktualizujte interaktivní figurku v aplikaci LEGO® Super Mario™, abyste se mohli pustit do hraní

Aktualizujte interaktivnú figúrku v aplikácii LEGO® Super Mario™, aby ste mohli pustiť do hrania

Frissítsd interaktív figurád a LEGO® Super Mario™ alkalmazásban és készülj fel a játékra!

Actualizează-ți figurina interactivă în aplicația LEGO® Super Mario™ pentru a fi gata de joacă

Актуализирайте интерактивната фигура в приложението LEGO® Super Mario™, за да сте готови за игра

Atjaunini savu interaktīvo figūru LEGO® Super Mario™ lietotnē, lai būtu gatavs rotaļāties

Värskenda oma interaktiivset figuuri rakenduses LEGO® Super Mario™, et olla mängimiseks valmis

Atnaujinkite interaktyvią figūrėlę programėlėje „LEGO® Super Mario™“ ir pasiruoškite žaisti



LEGO® Super Mario™ app

LEGO® Super Mario™ App
Appli LEGO® Super Mario™
App LEGO® Super Mario™
App LEGO® Super Mario™
Aplicação LEGO® Super Mario™
乐高®超级马力欧™应用程序
Aplikacija LEGO® Super Mario™
Aplikace LEGO® Super Mario™
Aplikácia LEGO® Super Mario™
LEGO® Super Mario™ alkalmazás
Aplicația LEGO® Super Mario™
Приложение LEGO® Super Mario™
LEGO® Super Mario™ lietotne
LEGO® Super Mario™ rakendus
Programélé „LEGO® Super Mario™“



[LEGO.com/super-mario-trouble-shooting-guide](https://www.lego.com/super-mario-trouble-shooting-guide)



71430



71360

OR



71387

OR



71403

OR / ODER / OU / OPPURE / O / 或 / LUB / NEBO / ALEBO / VAGY / SAU / ИЛИ / ВАИ / VÕI / ARBA

**DISCOVER MORE
ABOUT YOUR
SET IN THE APP**



Discover more about your set in the app
Entdecke in der App noch mehr über dein Set
Découvre plus de détails sur ton set dans l'appli
Scopri di più sul tuo set nell'app
Descubre más acerca de tu set en la app
Conhece melhor o teu set na aplicação
可通过应用程序了解更多关于此套装的信息
Dowiedz się więcej sprawdzając w aplikacji
Zjistěte více o své stavebnici v aplikaci
Zisti viac o svojej stavebnici v aplikácii
Tudj meg többet a készletről az alkalmazásban!
Descoperă mai multe despre setul tău în aplicație
Откройте повече за комплекта в приложението
Atklāj vairāk par komplektu lietotnē
Avasta oma komplekti kohta lisateavet rakendusest
Sužinokite daugiau apie rinkinį programėlėje



71429

71360

71428

71432



71430



71431



71360

Starter Course 71360 and/or 71387 and/or 71403 needed

Starterset 71360 und/oder 71387 und/oder 71403 wird benötigt

Pack(s) de démarrage 71360 et/ou 71387 et/ou 71403 nécessaire(s)

Starter Pack 71360 e/o 71387 e/o 71403 necessari

Se necesita el Pack Inicial 71360 y/o 71387 y/o 71403

Necessita do Pack Inicial 71360 e/ou 71387 e/ou 71403

スターターセット (71360/71387/71403 のいずれか)が
必要です

需要入门套组 71360 和/或 71387 和/或 71403

스타터팩 71360, 71387 또는 71403 이 필요합니다

Для игры необходимы Стартовые наборы
(арт. 71360 и/или 71387, и/или 71403)

Potrzebne są zestawy startowe 71360, 71387 i/lub
71403

Je zapotřebí startovací set 71360 nebo 71387
nebo 71403

Je potrebný štartovací set 71360 a/alebo 71387 a/
alebo 71403

A 71360-as és/vagy a 71387-es és/vagy a 71403-as
Kezdőpálya szükséges

Este nevoie de Setul de bază 71360 și/sau 71387 și/
sau 71403

Нужни са начална писта 71360 и/или 71387 и/или
71403

Nepieciešams sākuma maršruta komplekts 71360
un/vai 71387, un/vai 71403

Vaja on alustusrada 71360 ja/või 71387 ja/või 71403

Reikalingas pradinis rinkinys 71360 ir (arba) 71387 ir
(arba) 71403



Rebuild
the
world™







Rebuild
the
world™





2x
6186681



1x
614101



1x
6250591



1x
6052864



1x
300501



1x
4558952



1x
307001



3x
4504369



2x
302401



2x
6224811

1x
4224792

2x
6093053

7x
6059185

6x
6285777

2x
6166894

1x
6034044

2x
302301

4x
6138740

1x
4179580

1x
4558168

2x
371001

2x
6045936

1x
301001



1x
4143254



2x
303701



2x
302001



1x
300101



2x
4583297



3x
6315195



2x
6147792



2x
366601



2x
6296243



1x
4243812

1x
379501

2x
6427625

1x
4144012



2x
6249095

2x
6246842



2x
6232135



6x
6212758

1x
4114084



1x
6469454

1x
6365073

2x
4504380



4x
6382171



1x
4583862



2x
4206330



2x
6249783



2x
4121936



7x
302323



2x
6189191



4x
366523



4x
6069163



2x
6308097



2x
303923



1x
6388503



2x
4653712



2x
4543998

1x
302123

3x
6196596

2x
371023

1x
301023

2x
302023

1x
4504381

1x
6381923

4x
4188313

1x
6308887

1x
370526

2x
4570877

1x
6186423

1x
6308927

1x
6315663

2x
6104344

1x
6274739

3x
6245277

2x
6244910

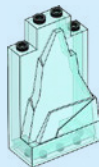

2x
6240045



2x
4623481

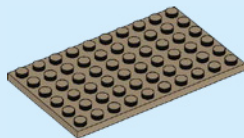

1x
6096215



1x
6426731



2x
6426730



1x
4211183



2x
4221744



2x
6433392



1x
6300006



2x
6409552



2x
4658005

3x
4211190

1x
4211194

1x
4538252



1x
4271874

1x
6052200

4x
4211614

1x
6123809

2x
6132886

2x
4211445

2x
4622803

1x
6176242

2x
4560183

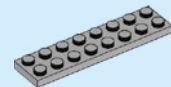

1x
4211406

1x
6115080

2x
4211135

2x
6314192

1x
4211002

1x
4210678

1x
6474683

2x
6466240

4x
6459289

4x
6150307

2x
6322830

3x
6060857

4x
6258069

1x
6102828

2x
6185309

5x
6472014



[LEGO.com/service](https://www.LEGO.com/service)

YOU COULD **WIN**

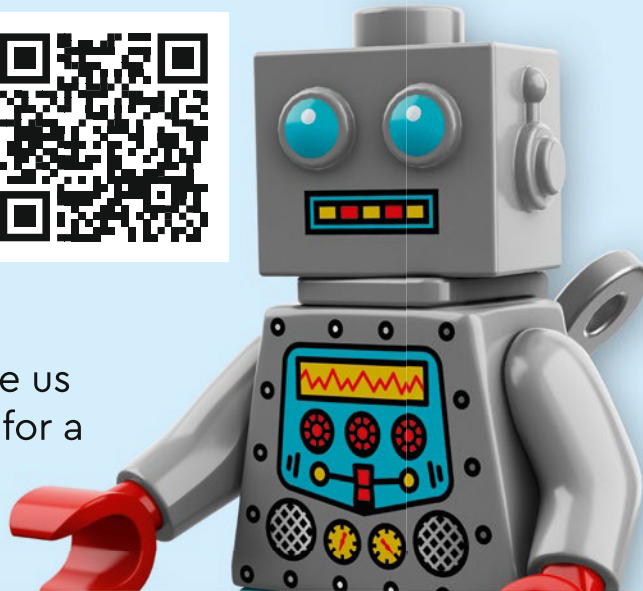

Scan this QR code or go to **LEGO.COM/PRODUCTFEEDBACK** and give us your short feedback about this LEGO® set for a chance to win a cool LEGO prize.

Terms and Conditions apply*

EN: YOU COULD WIN. Terms and Conditions apply* **DE: Du könntest GEWINNEN.** Es gelten die Teilnahmebedingungen* **FR: Tu pourrais GAGNER.** Des conditions s'appliquent* **IT: Potresti VINCERE tu.** Termini e condizioni sono applicabili* **ES: Puedes GANAR.** Aplican términos y condiciones* **PT: Poderá GANHAR.** Aplicam-se termos e condições* **ZH: 轻松获奖. 条款和条件适用*** **PL: Szansa na WYGRANĄ.** Obowiązują warunki korzystania* **CS: Máte šanci VYHRÁT.** Platí všeobecné smluvní podmínky* **SK: Máte šancu VYHRAŤ.** Platia všeobecné zmluvné podmienky* **HU: TE IS NYERHETSZ.** Felhasználási feltételek érvényesek* **RO: Ai putea CÂȘTIGA.** Se aplică termeni și condiții* **BG: Можете да СПЕЧЕЛИТЕ.** Има определени правила и условия* **LV: Tu vari LAIMĒT.** Ir spēkā noteikumi un nosacījumi.* **ET: Sul on võimalus VÕITA.** Kehtivad tingimused* **LT: Jūs galite LAIMĖTI.** Taikomos sąlygos*

*[LEGO.com/productfeedback-terms](https://www.lego.com/productfeedback-terms)

LEGO, the LEGO logo and the Brick and Knob configurations are trademarks and/or copyrights of the LEGO Group. ©2024 The LEGO Group.

TM & © 2024 Nintendo.

6500163