



# CITY

60422



7

8

9

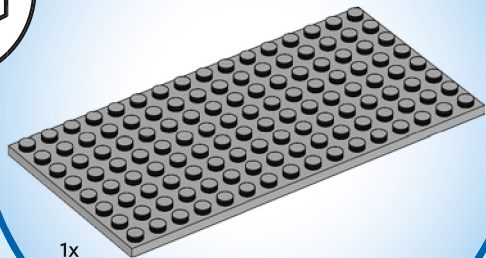
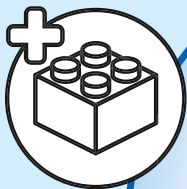

1x

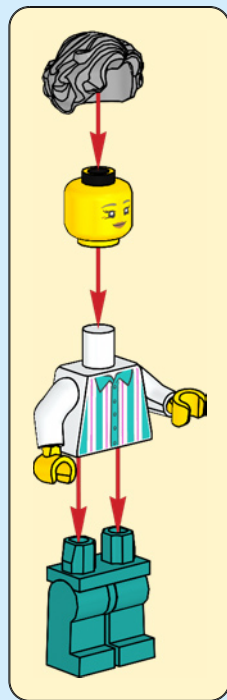



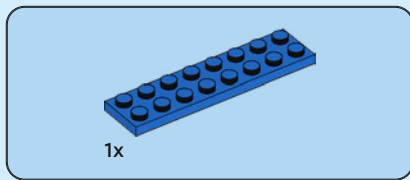

1

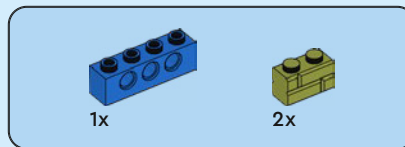
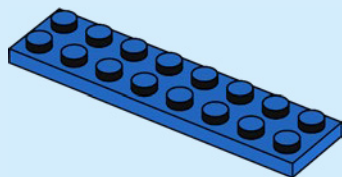

2

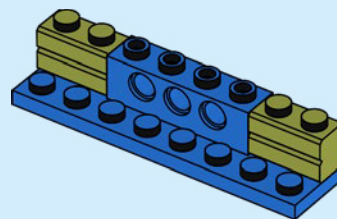

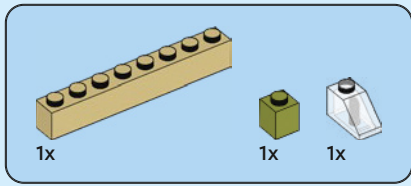

3

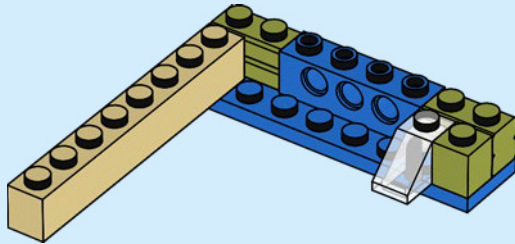

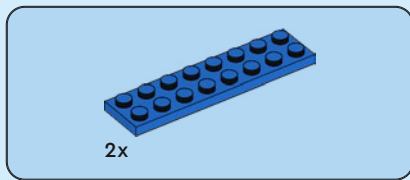

4

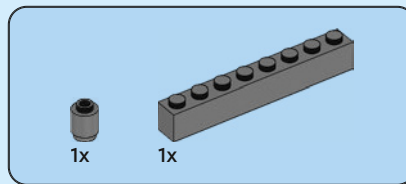
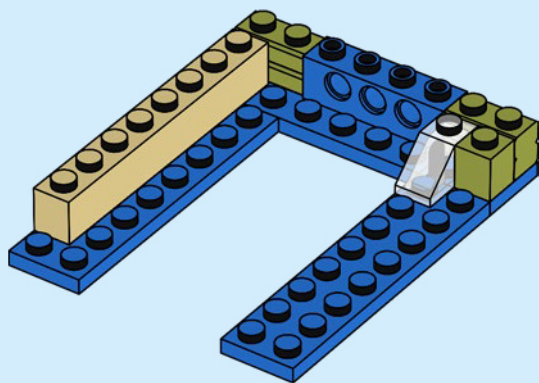

5

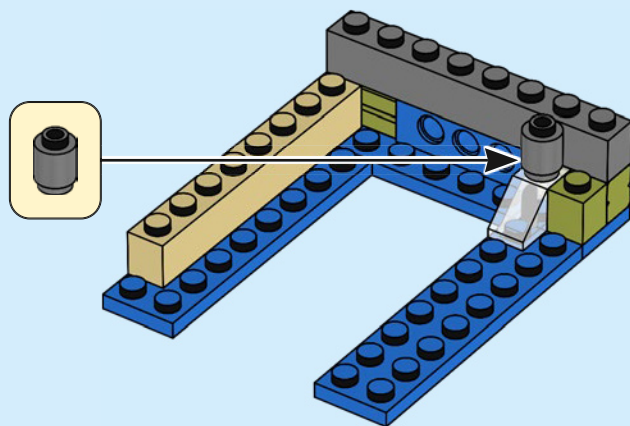

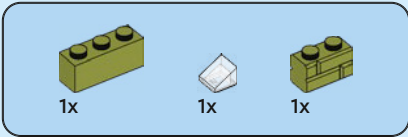

6

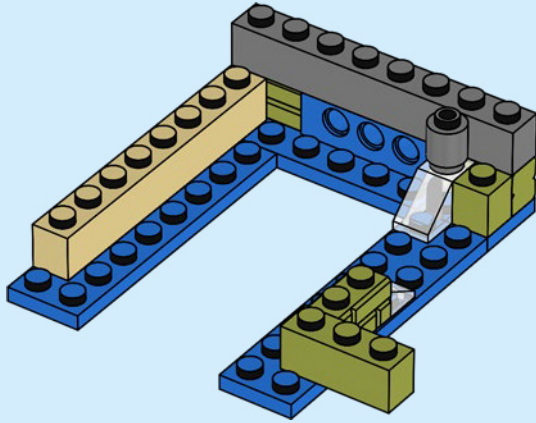



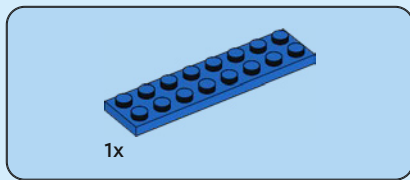

7

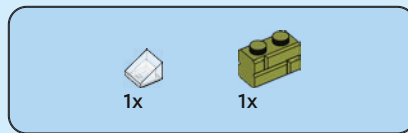
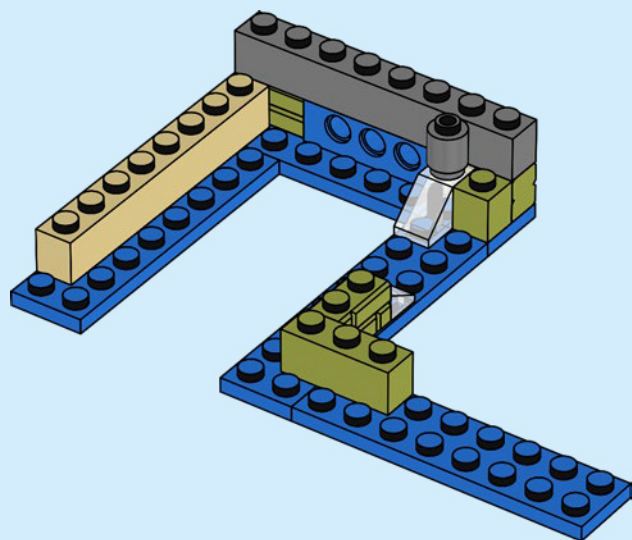

8

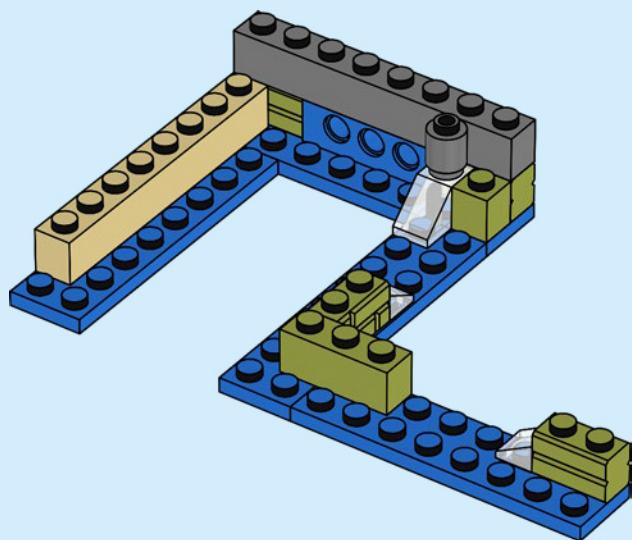

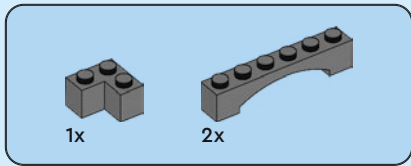

9

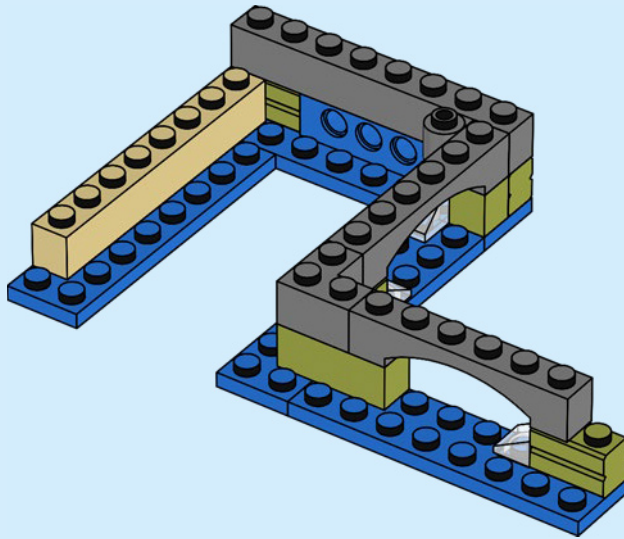

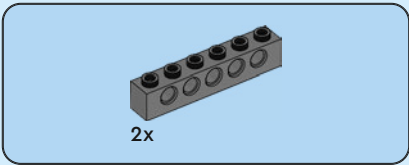

10

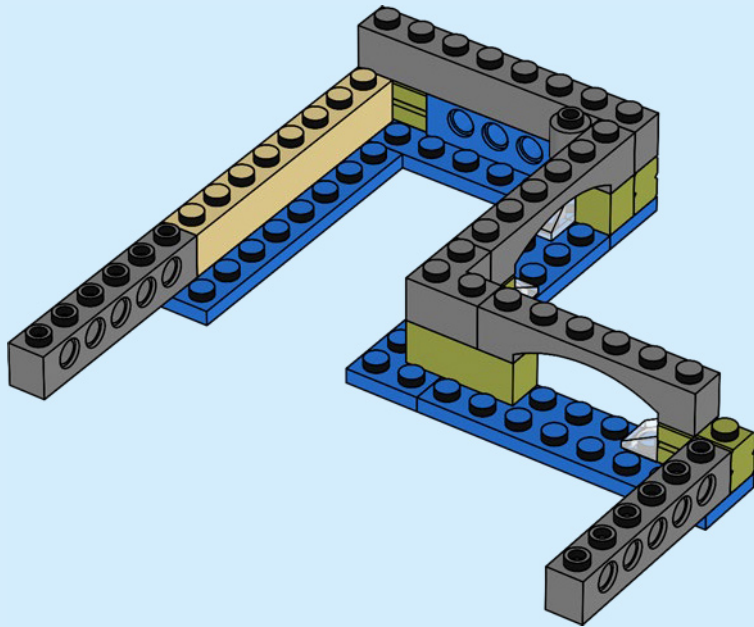

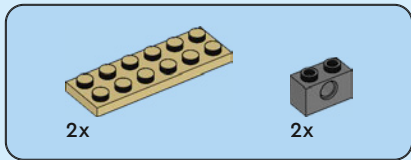

11

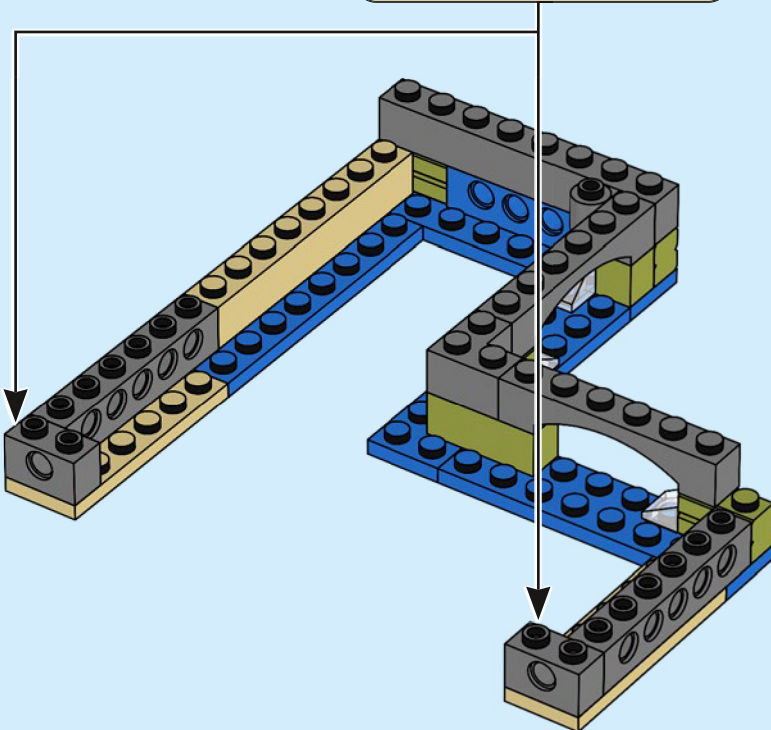
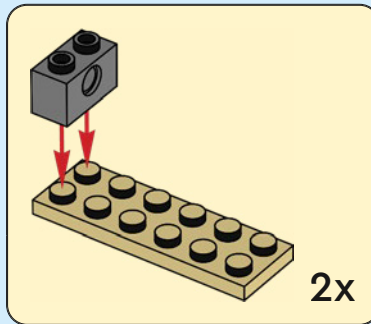



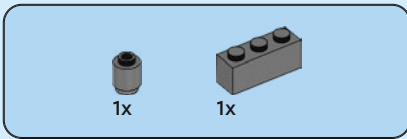

12

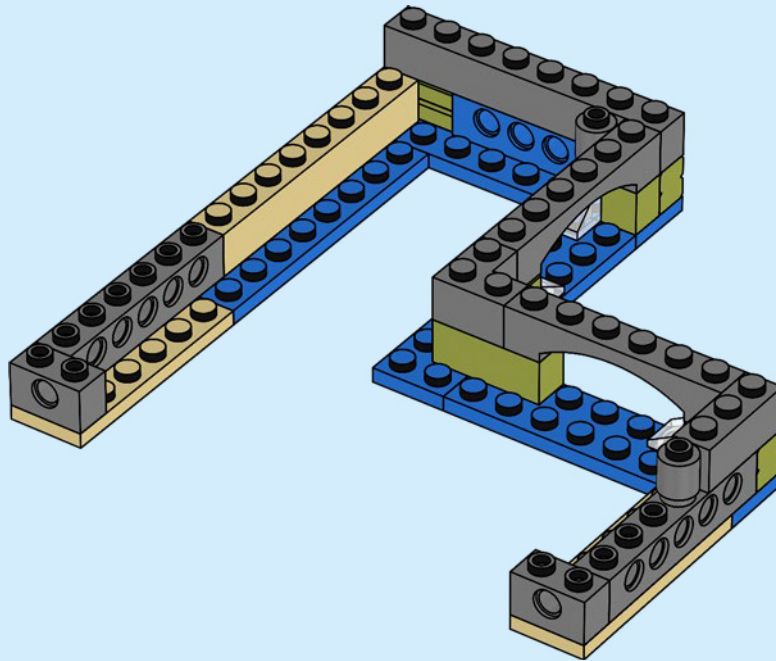

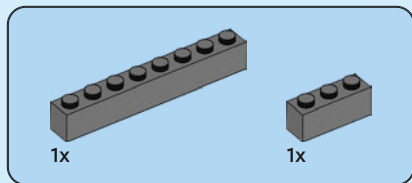

13

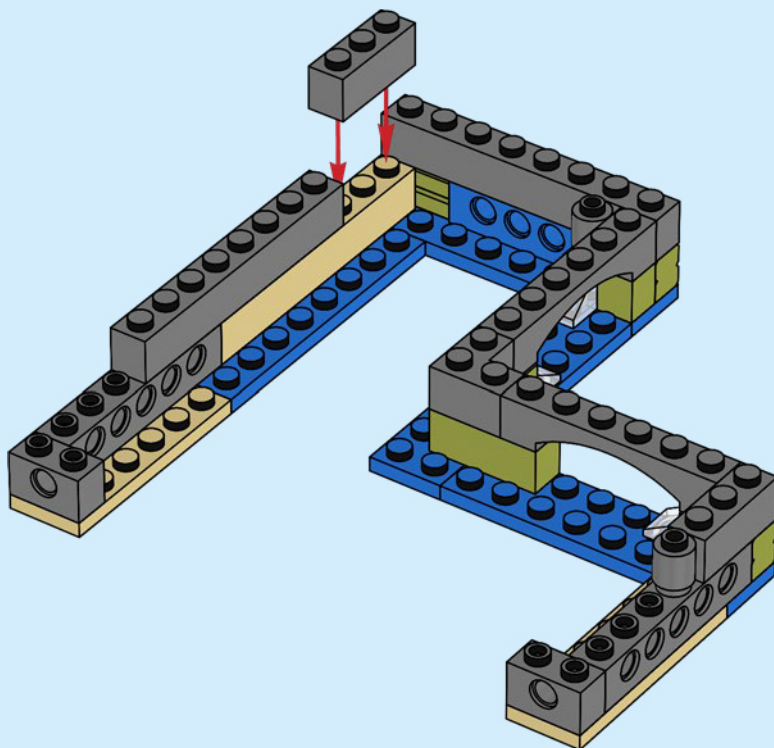

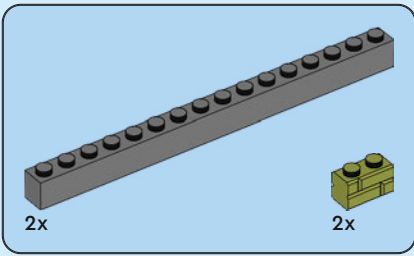

14

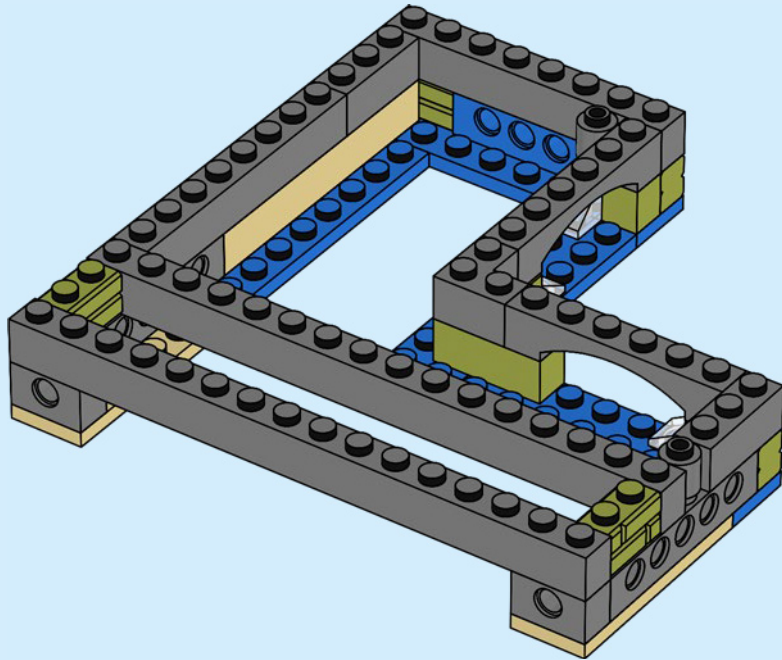

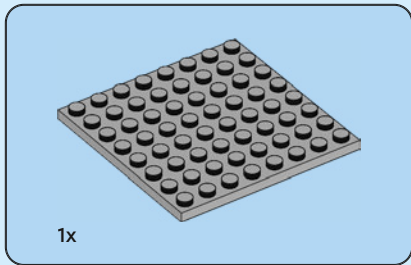

15

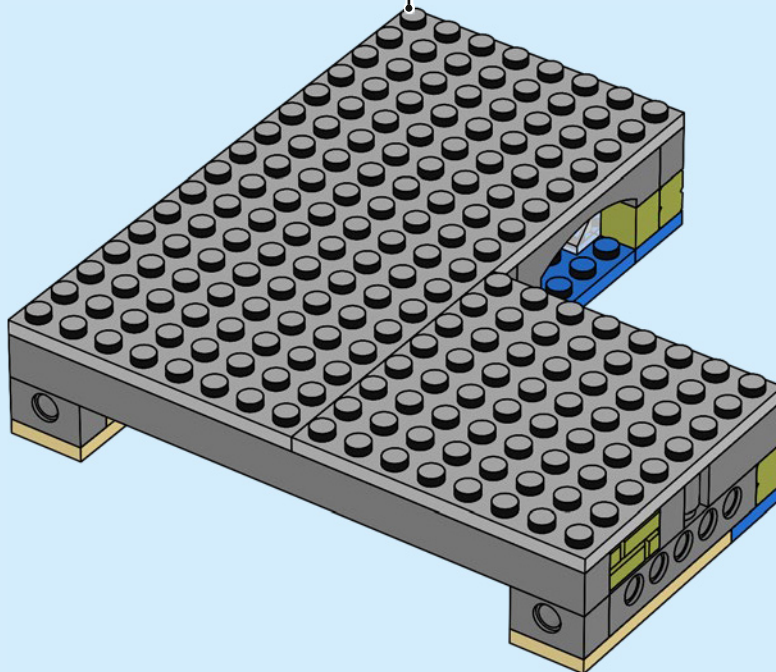
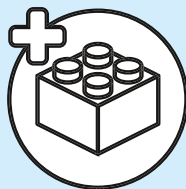





2x

16

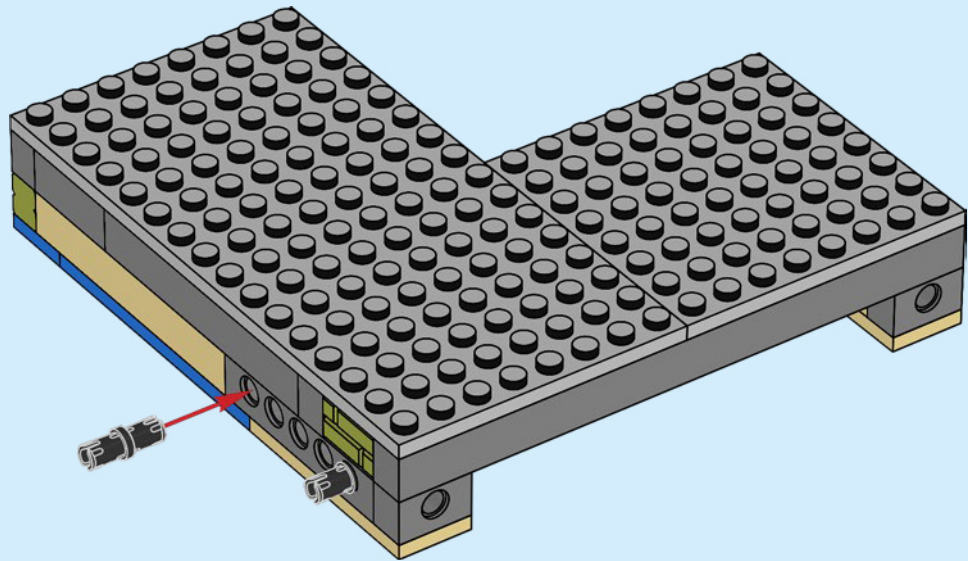

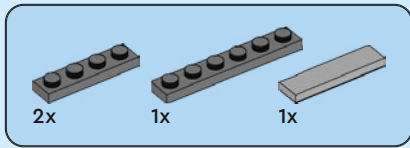

17

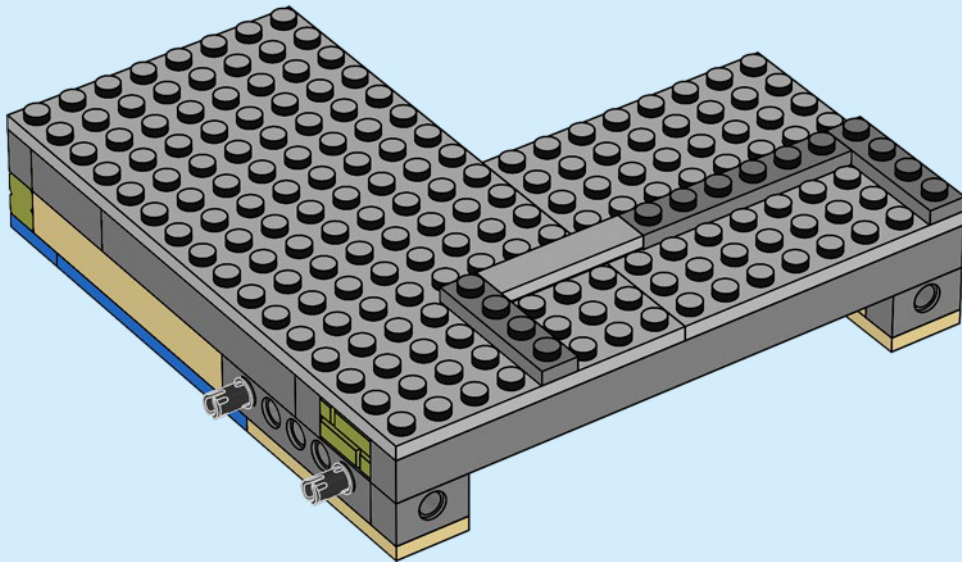

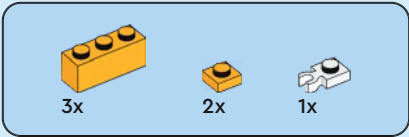

18

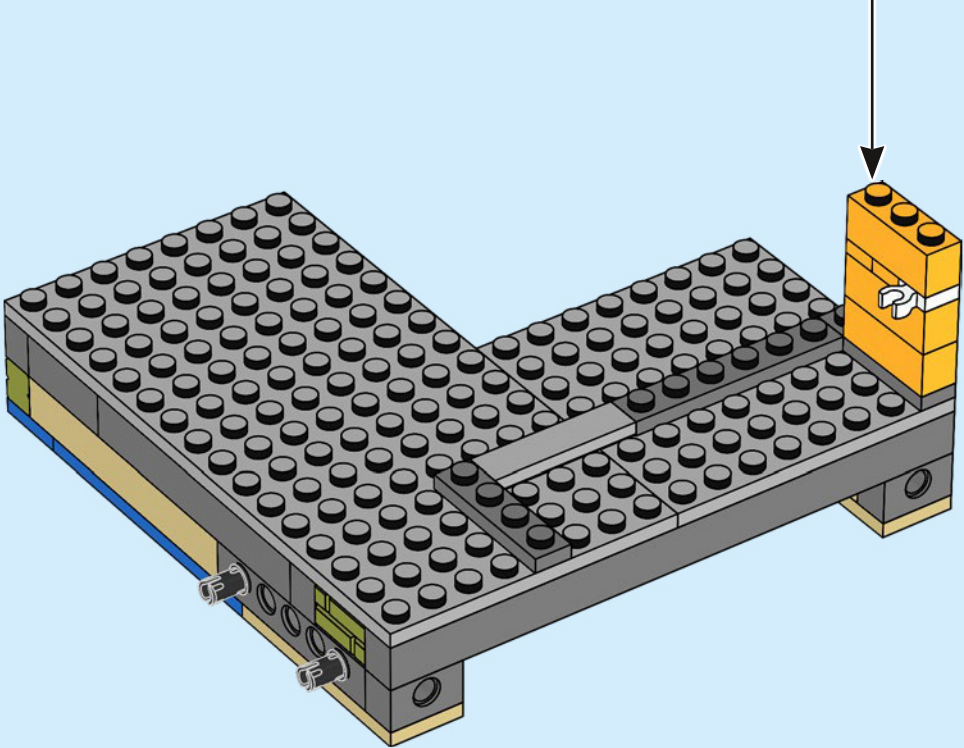
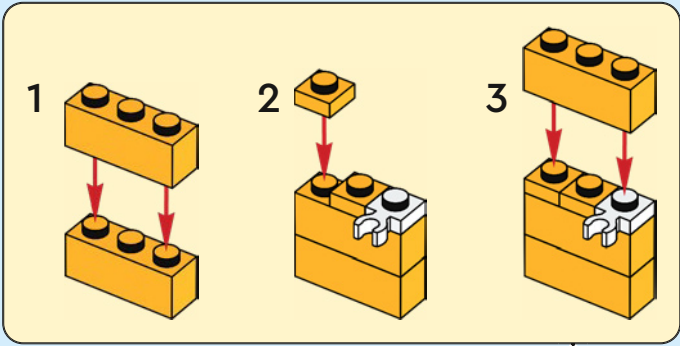

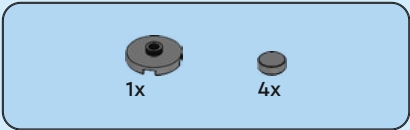

19

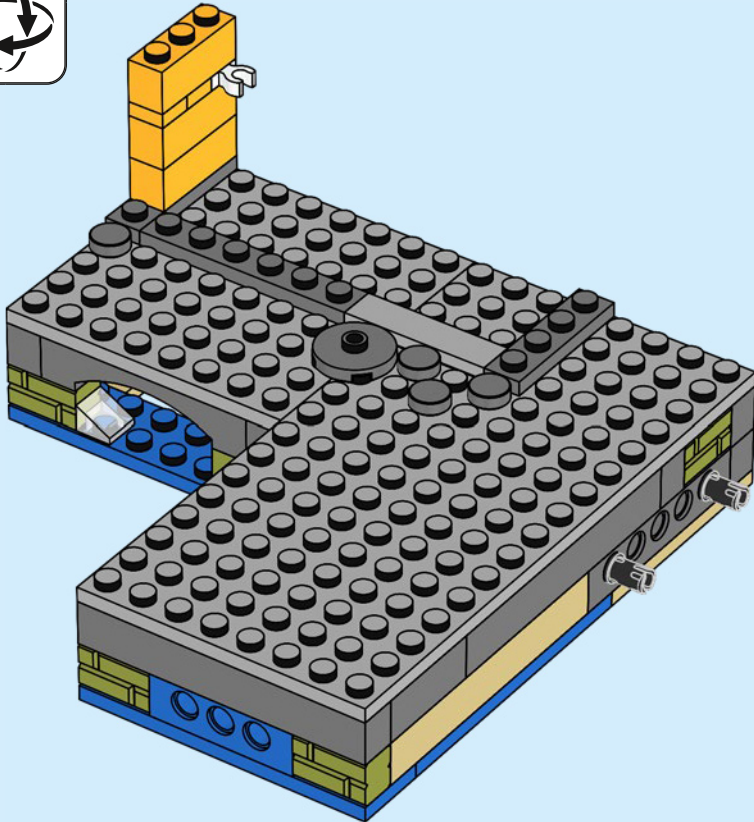





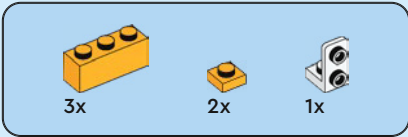

21

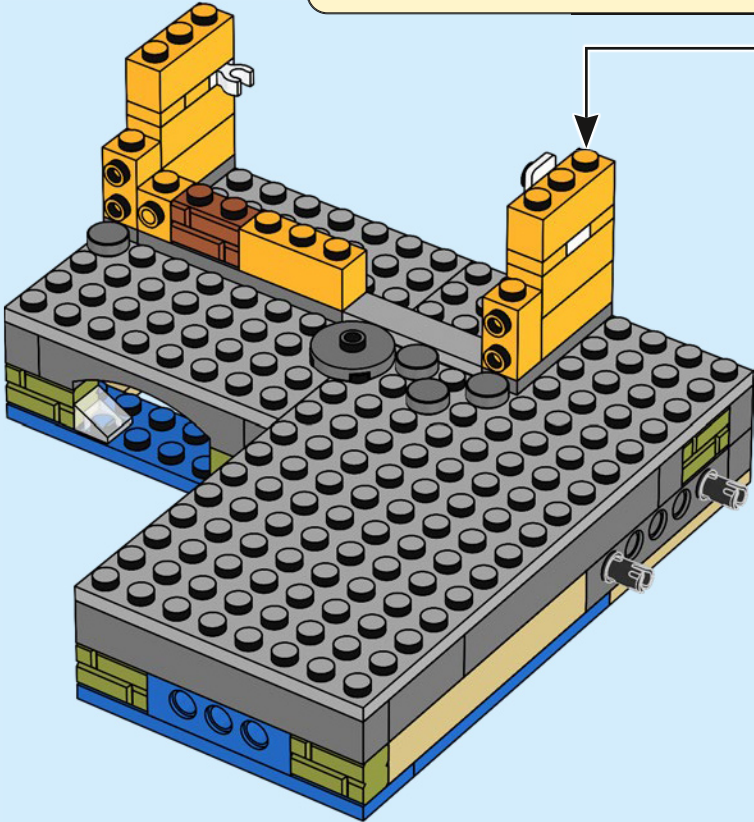
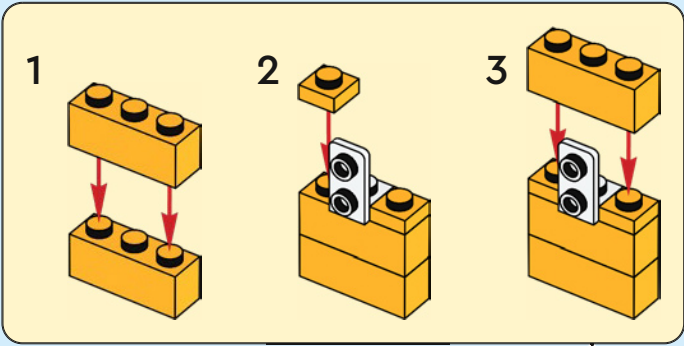

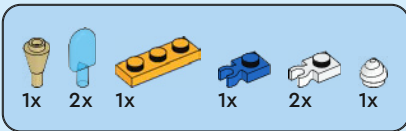

22

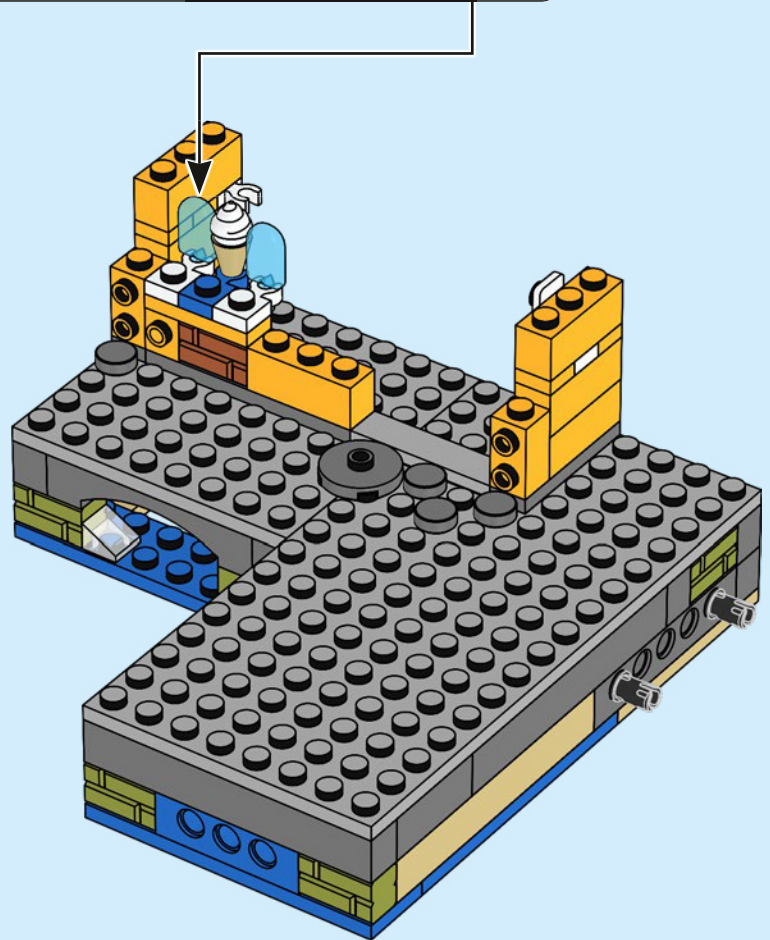

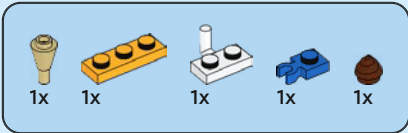

23

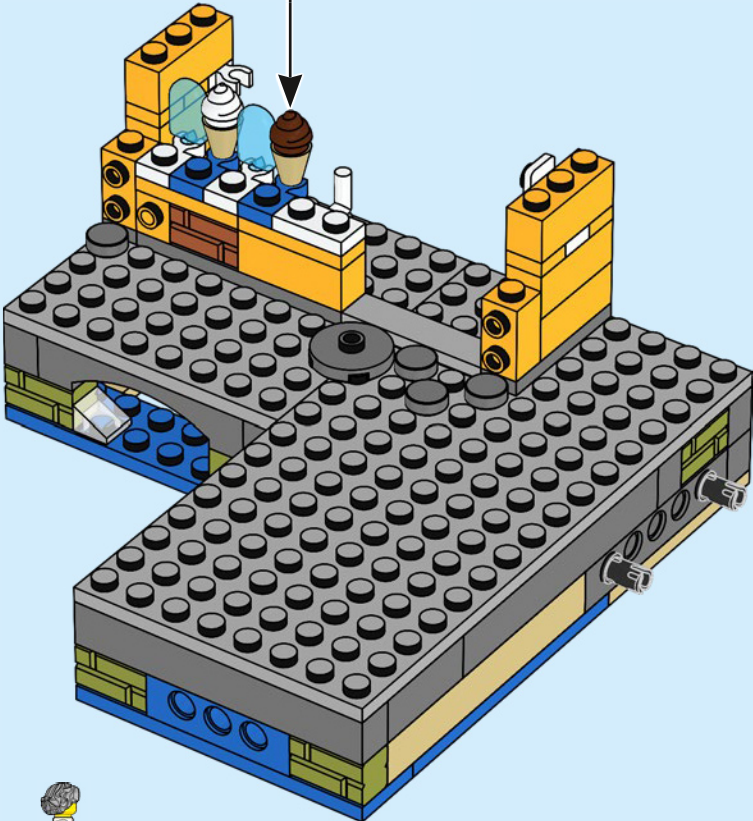
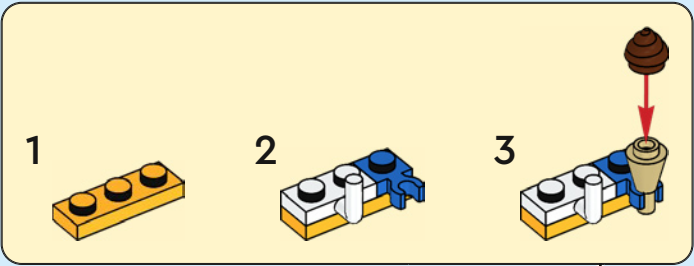



1x



1x

24

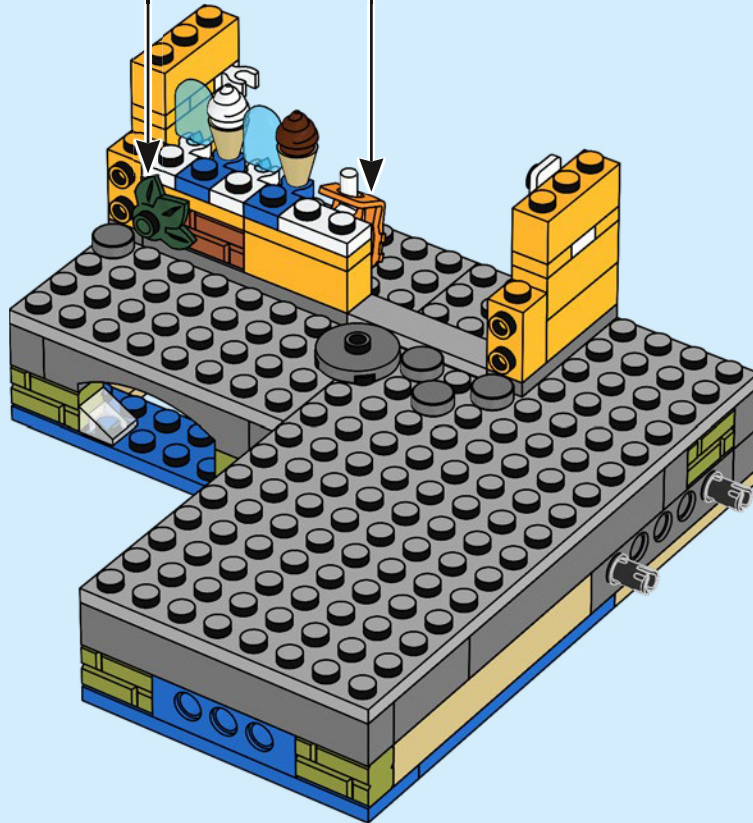





2x



4x

25



4x

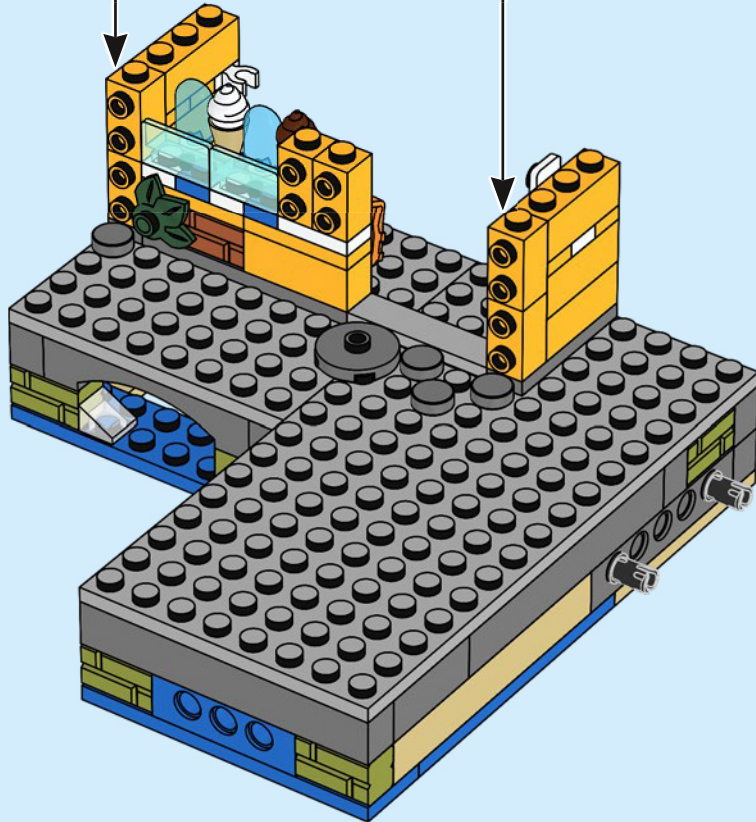

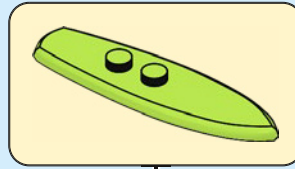
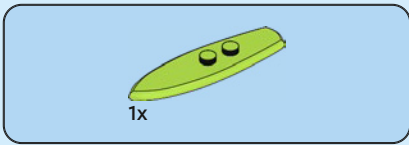

26

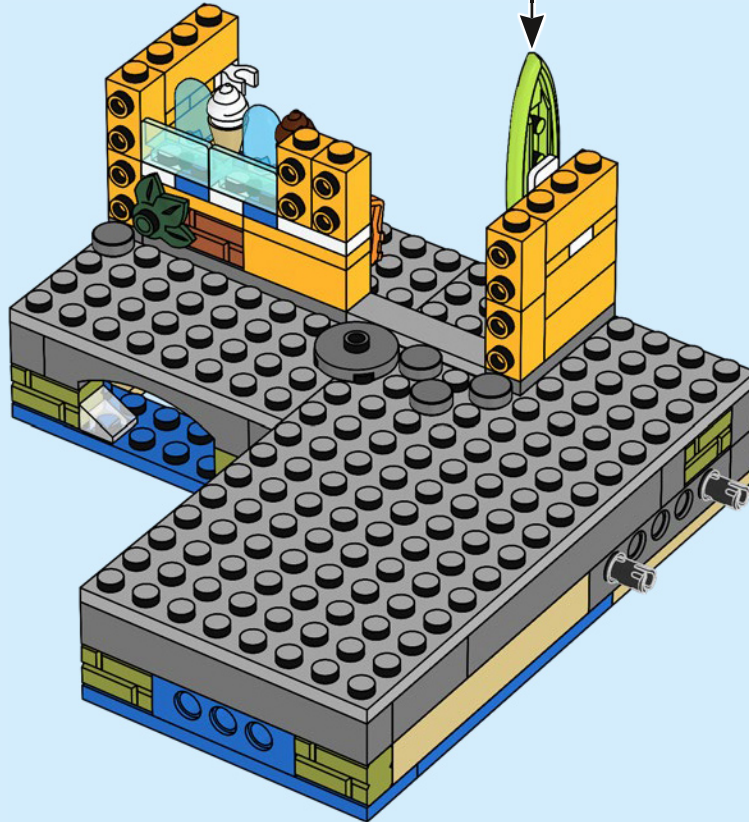

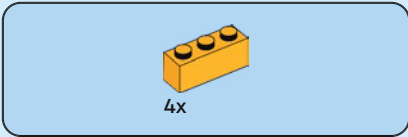

27

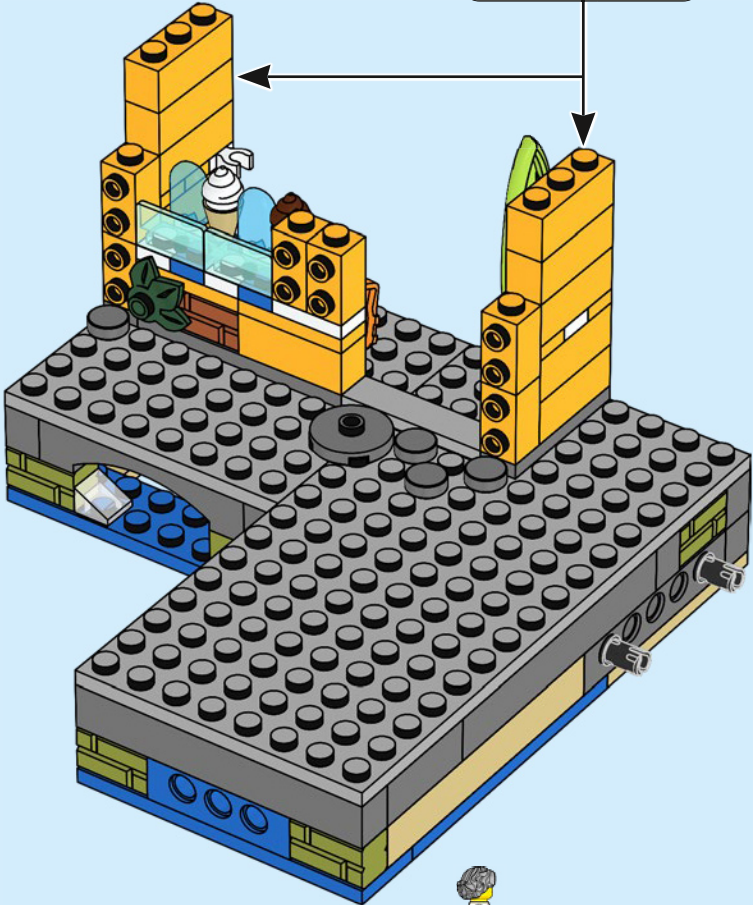
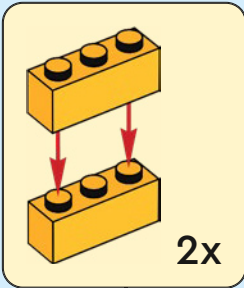



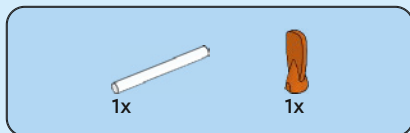

28

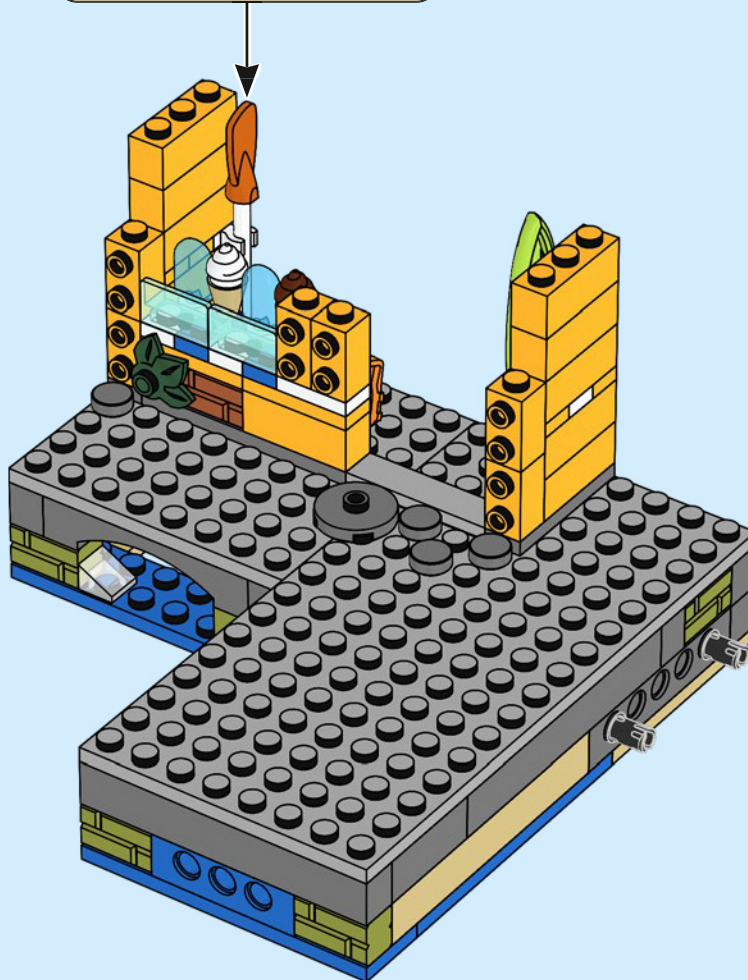
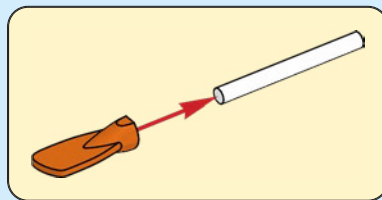

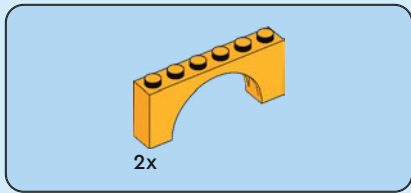

29

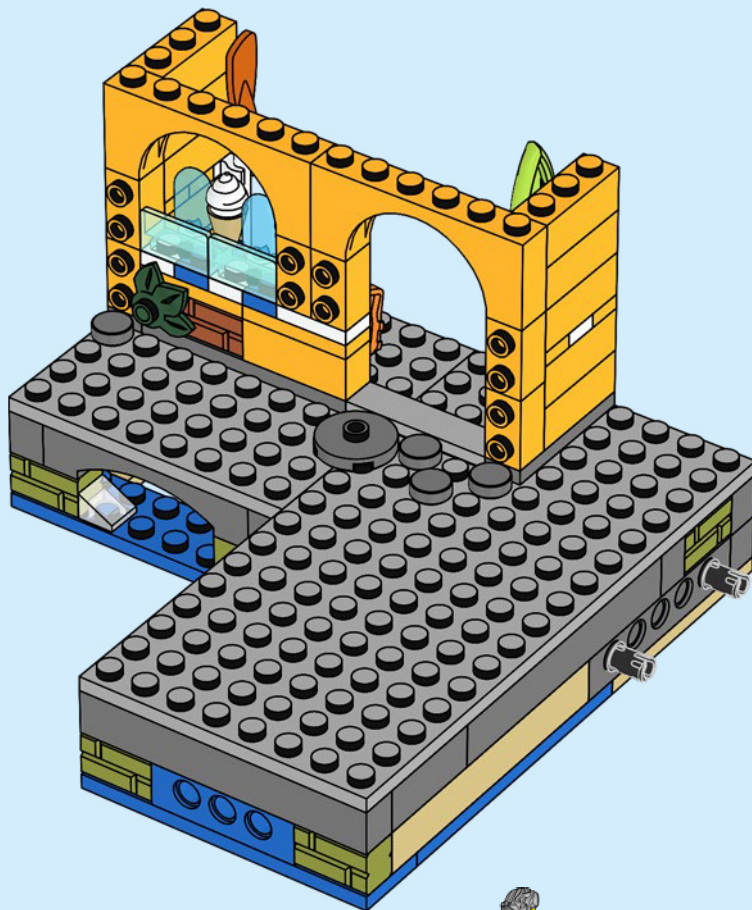

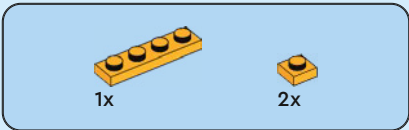

30

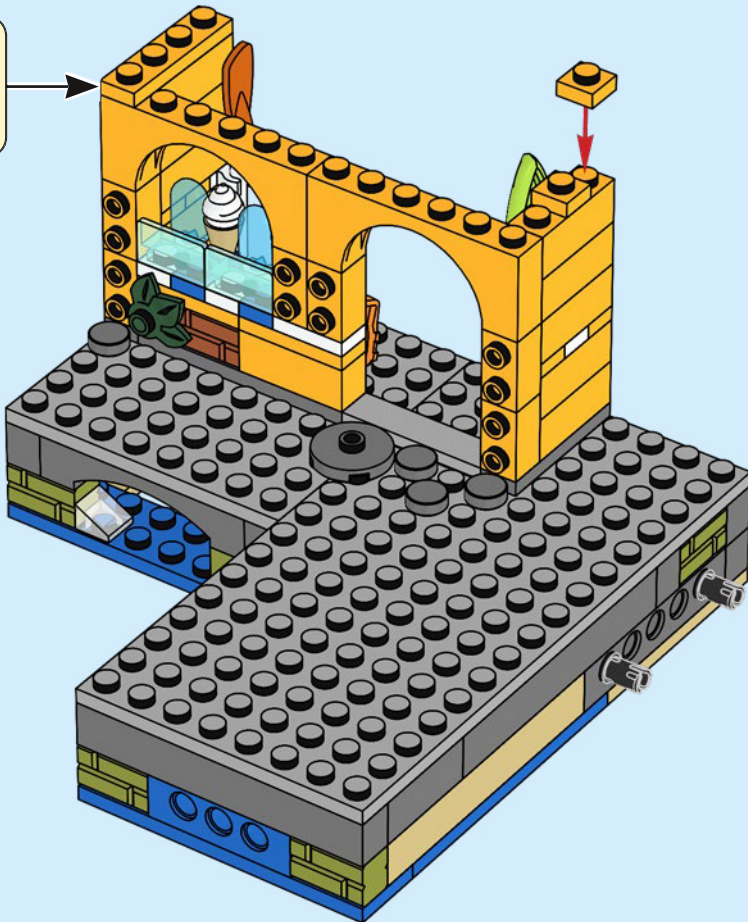
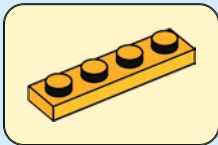

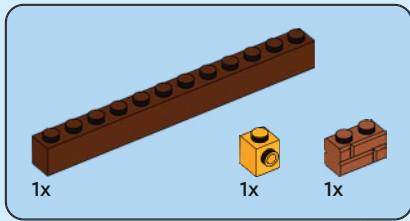

31

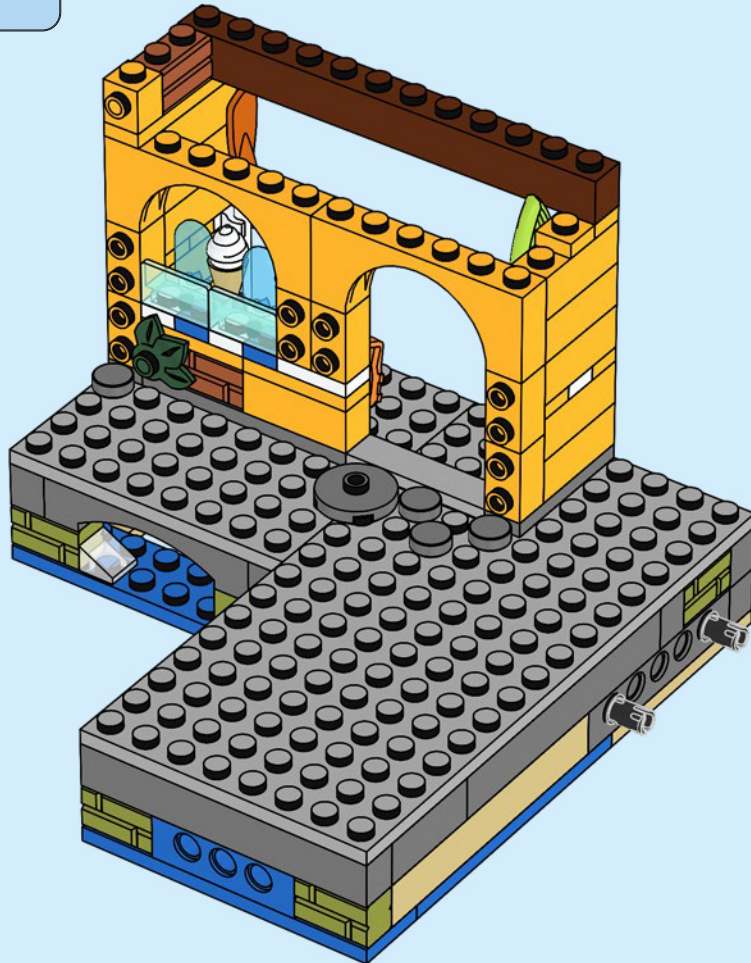

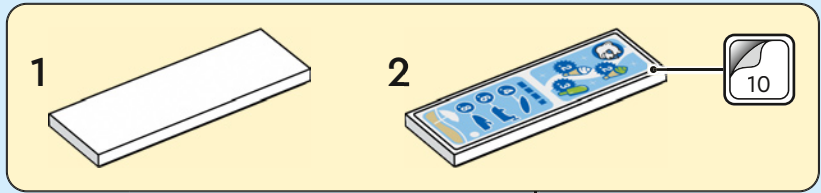
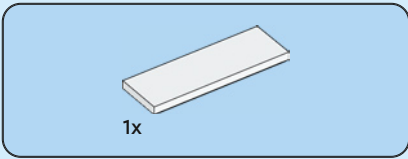

32

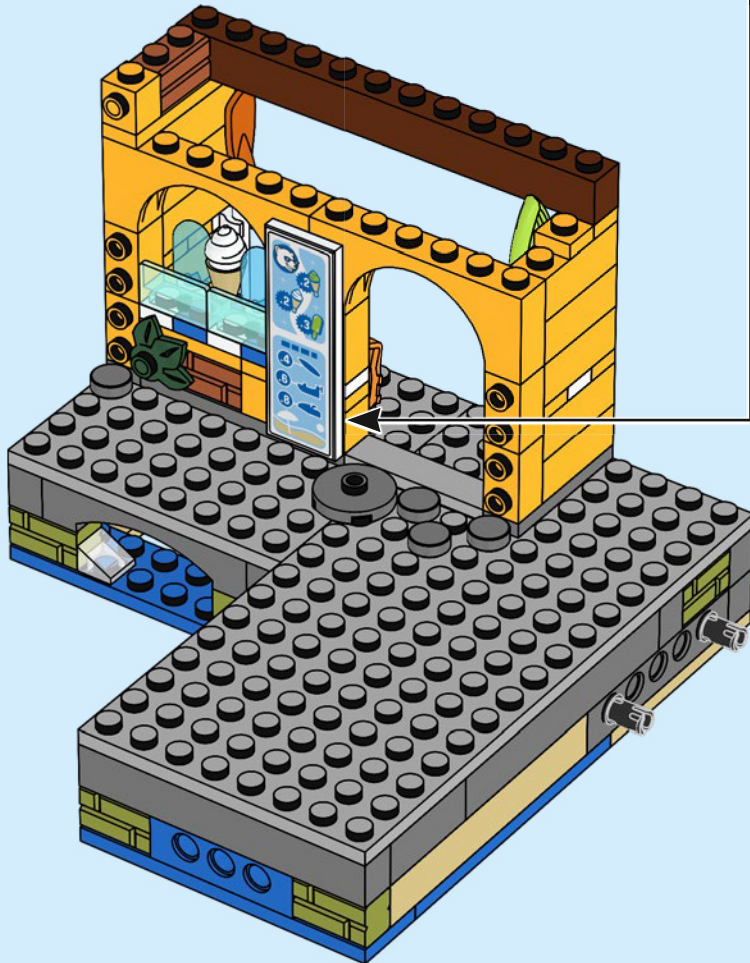



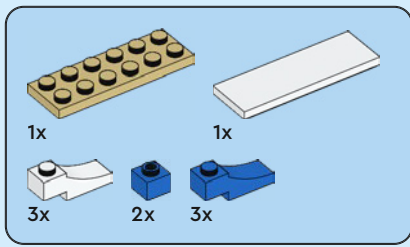

# 33

1

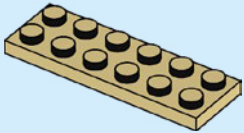

2

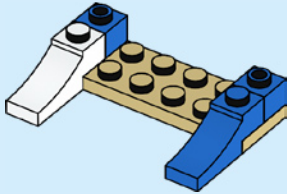

3

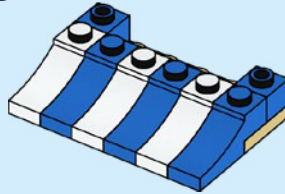

4

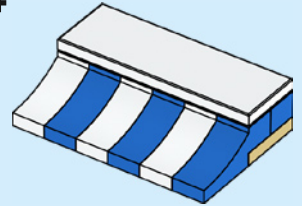



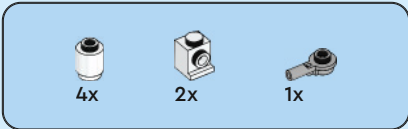

34

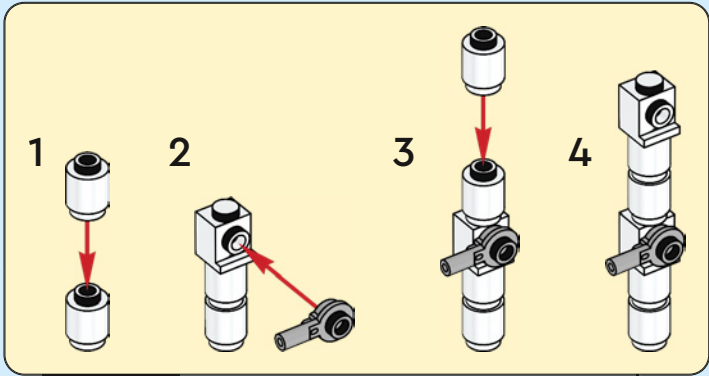



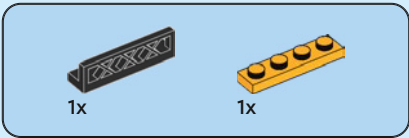

35

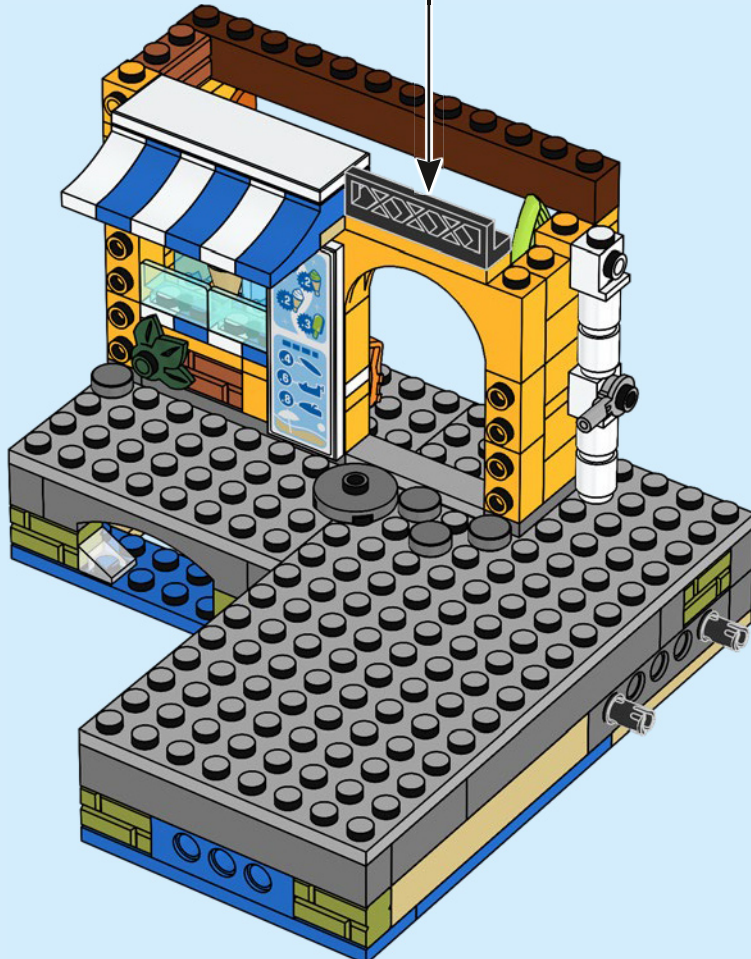
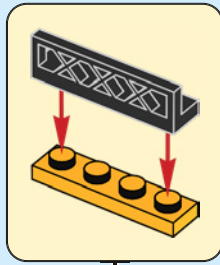

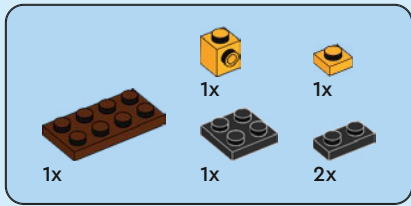

36

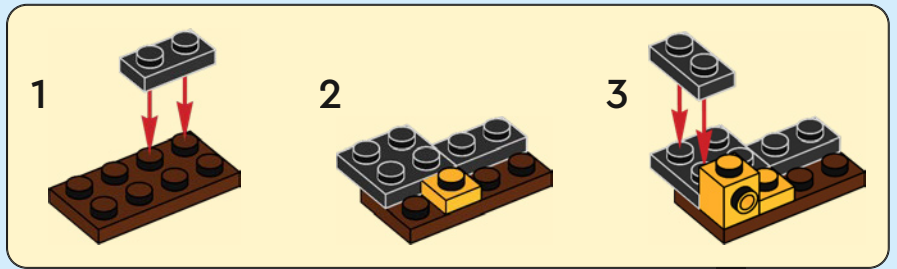



1x



1x



1x

# 37



1



2

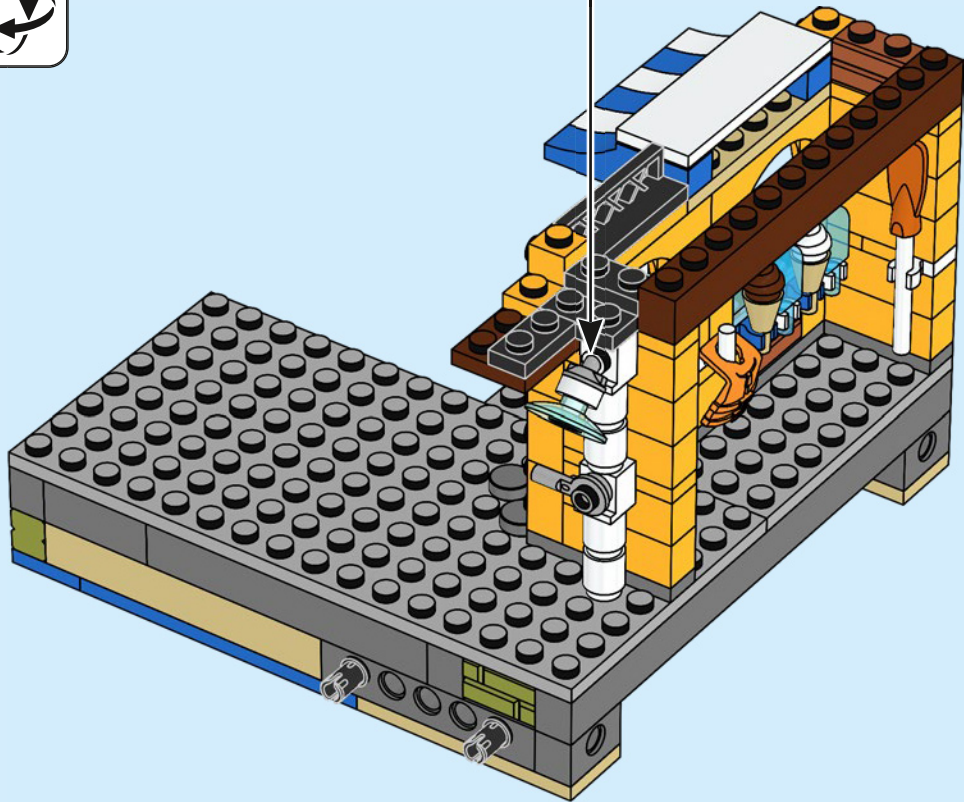



1x

38

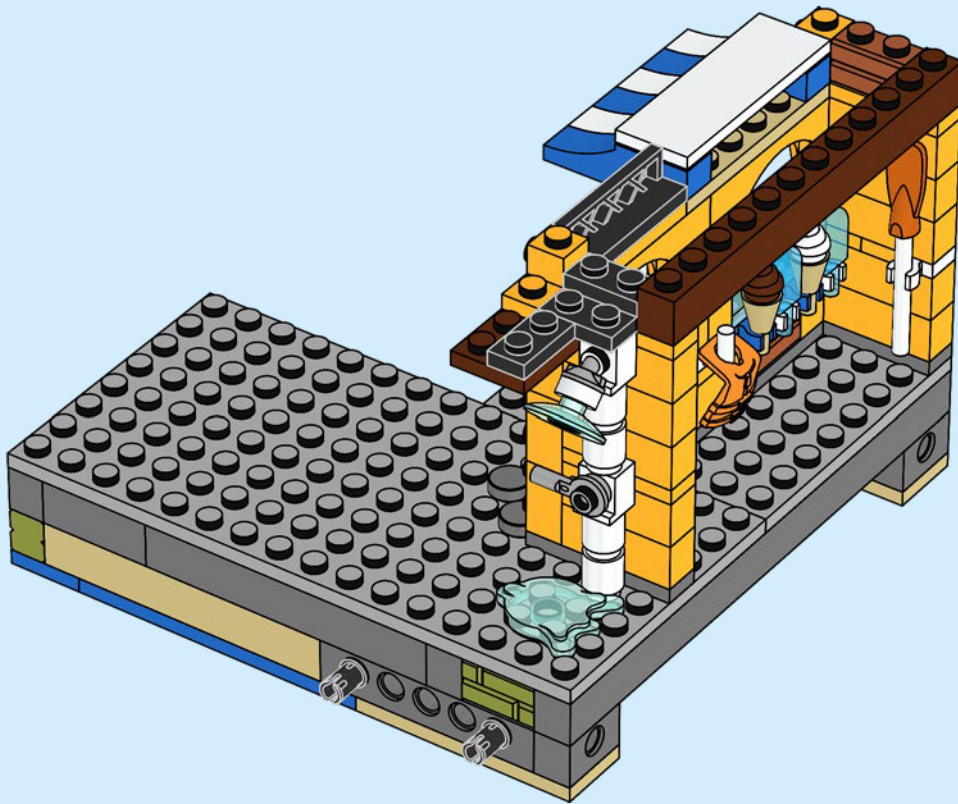



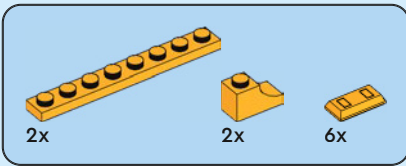

39

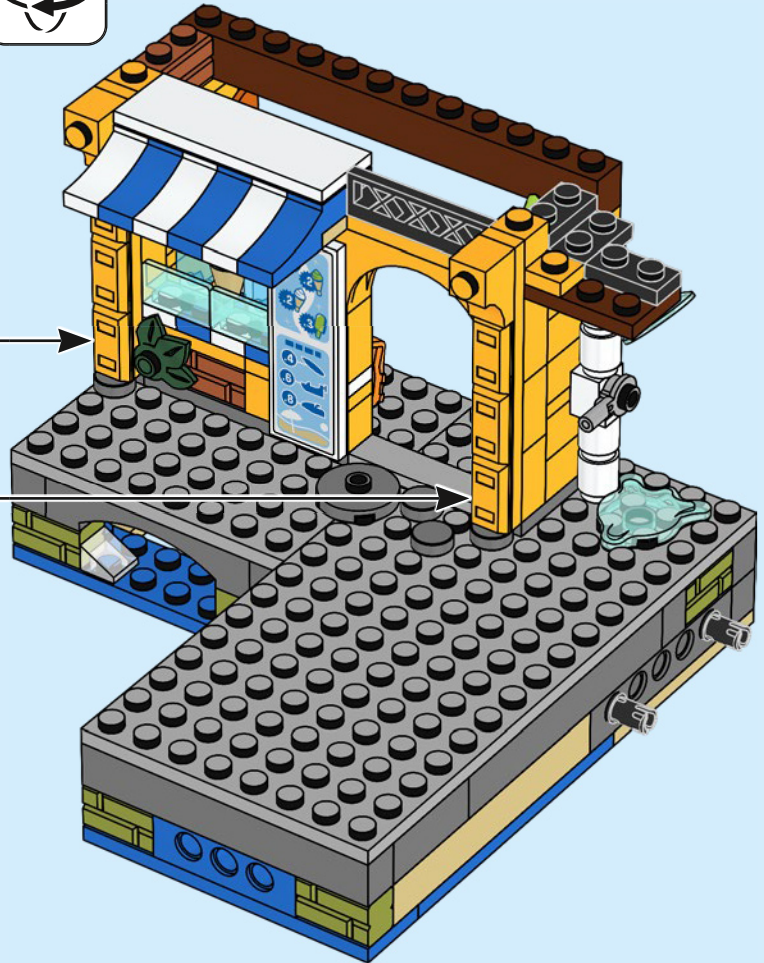
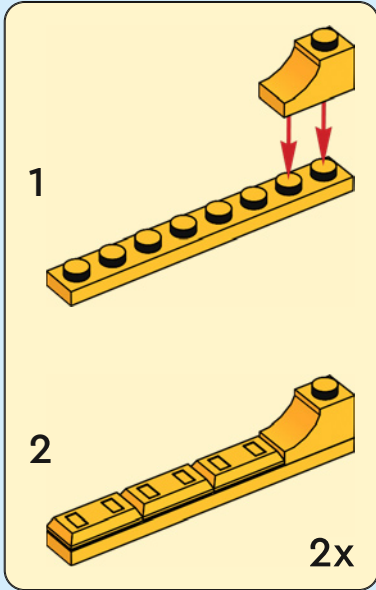

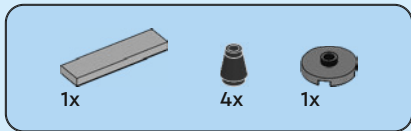

40

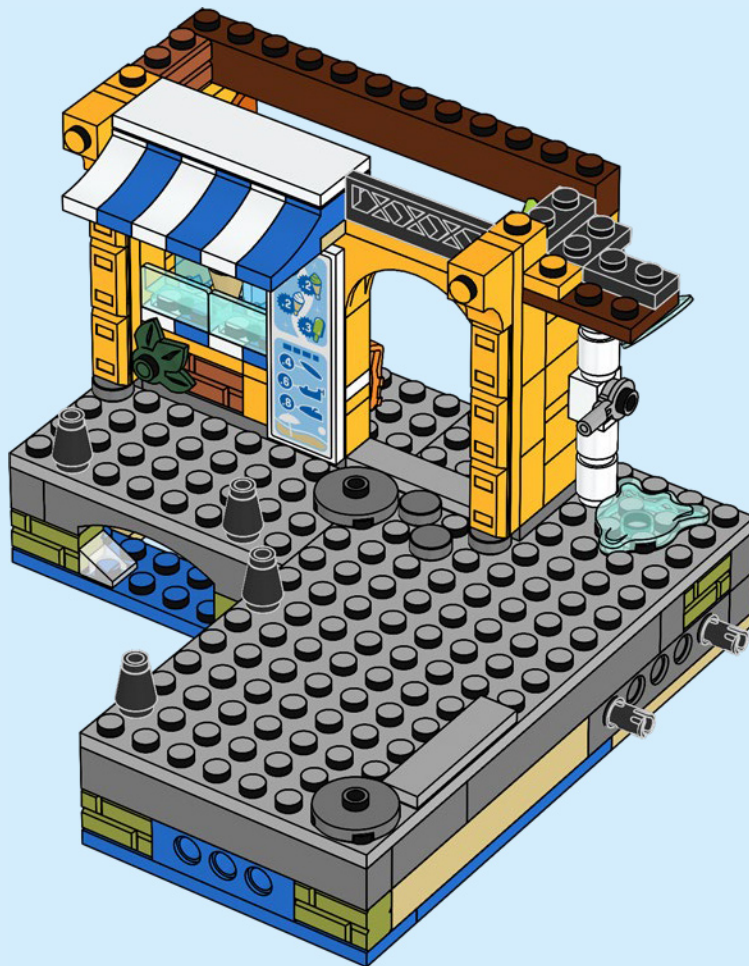

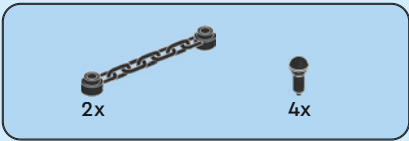

41

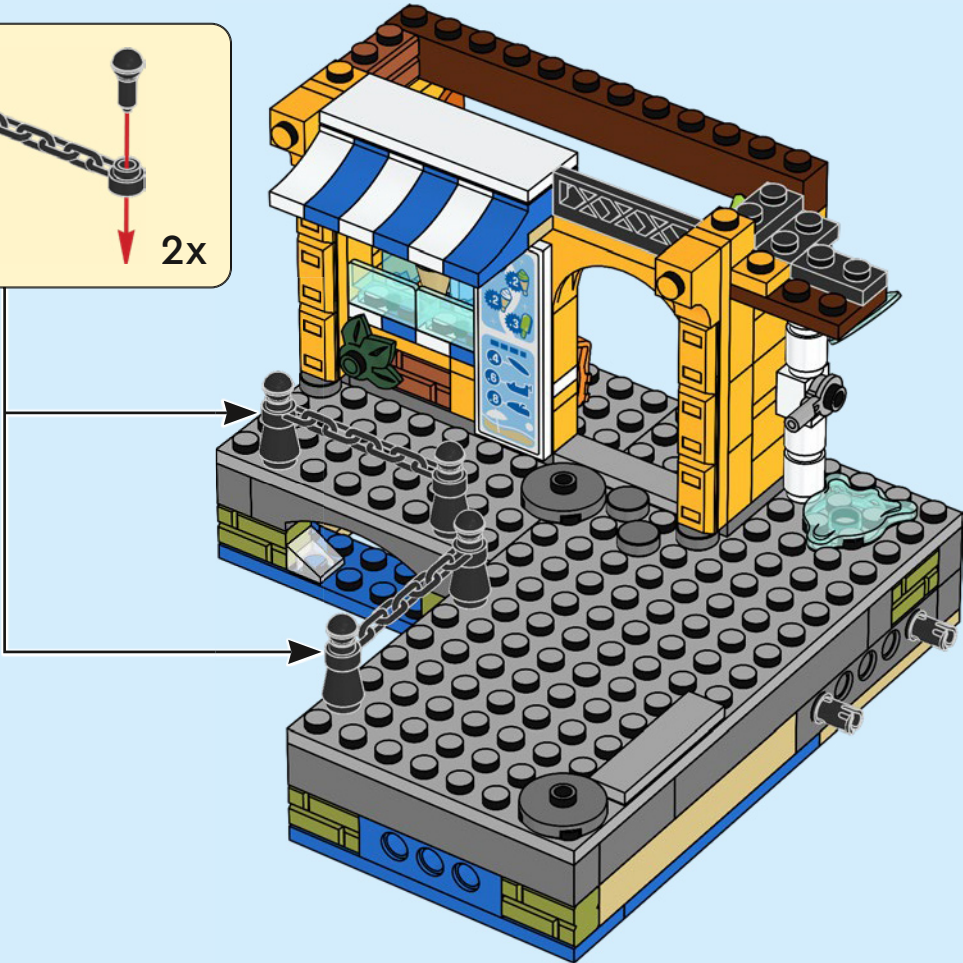
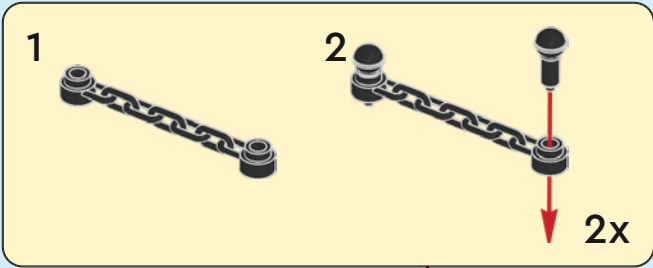



42

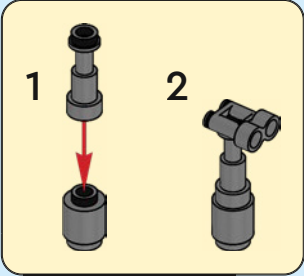
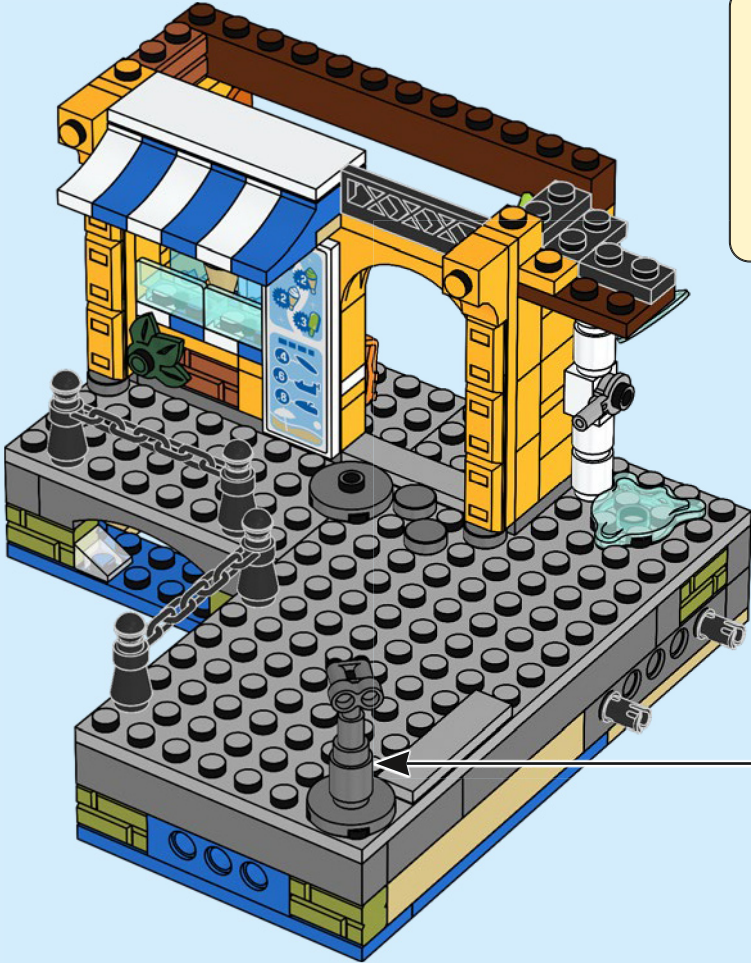



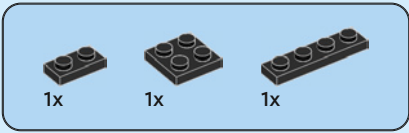

43

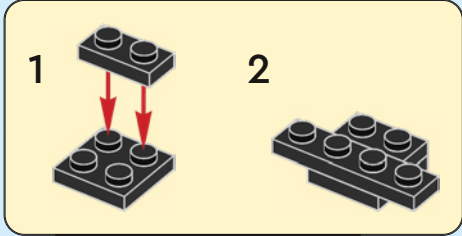
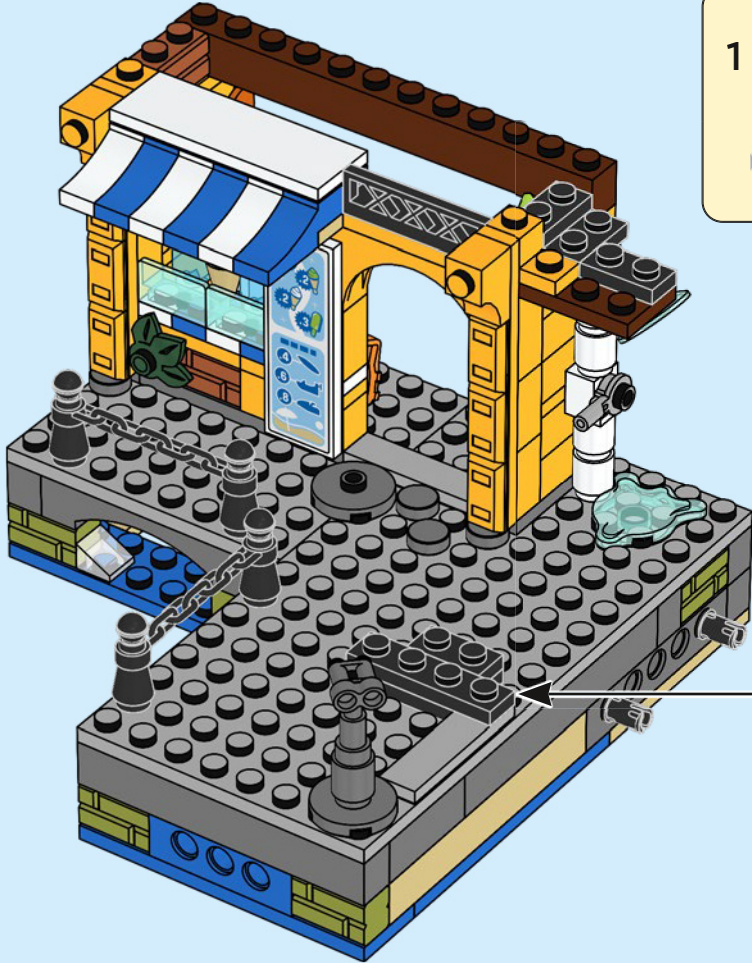





1x

45

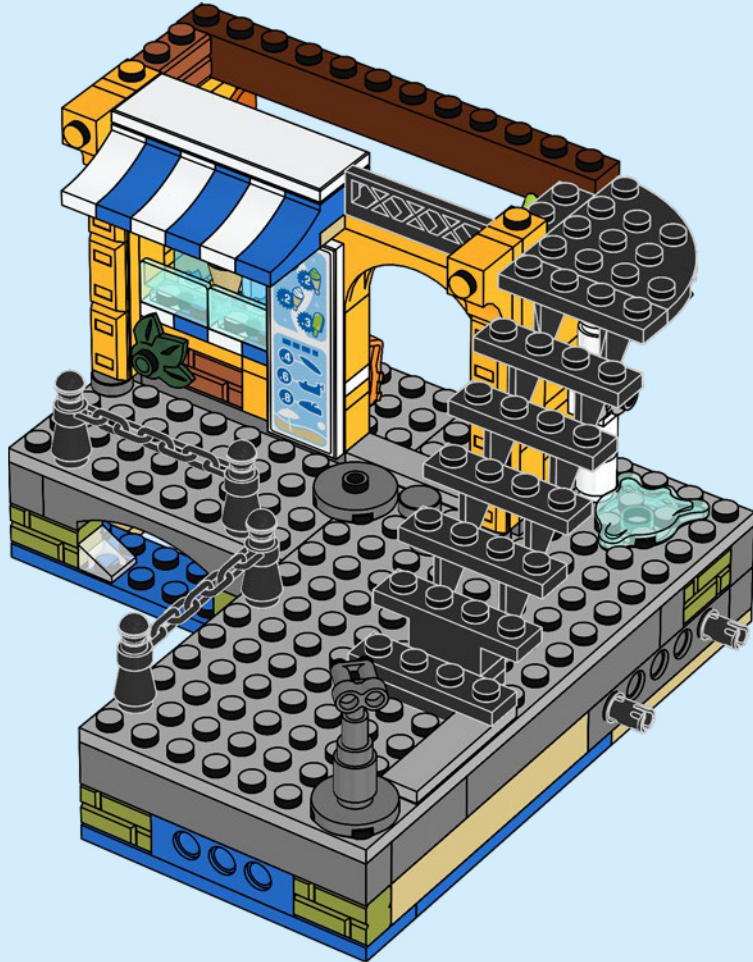



1x



1x

# 46

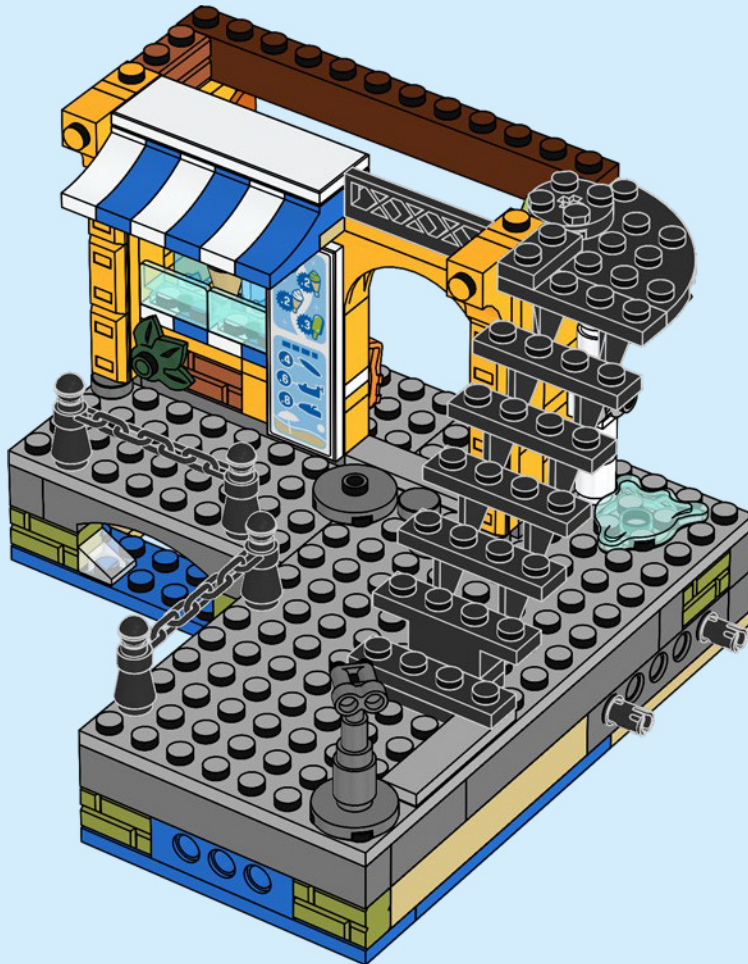



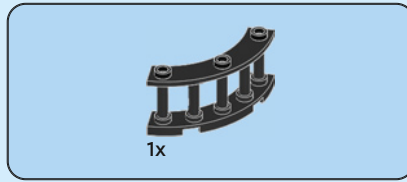

47

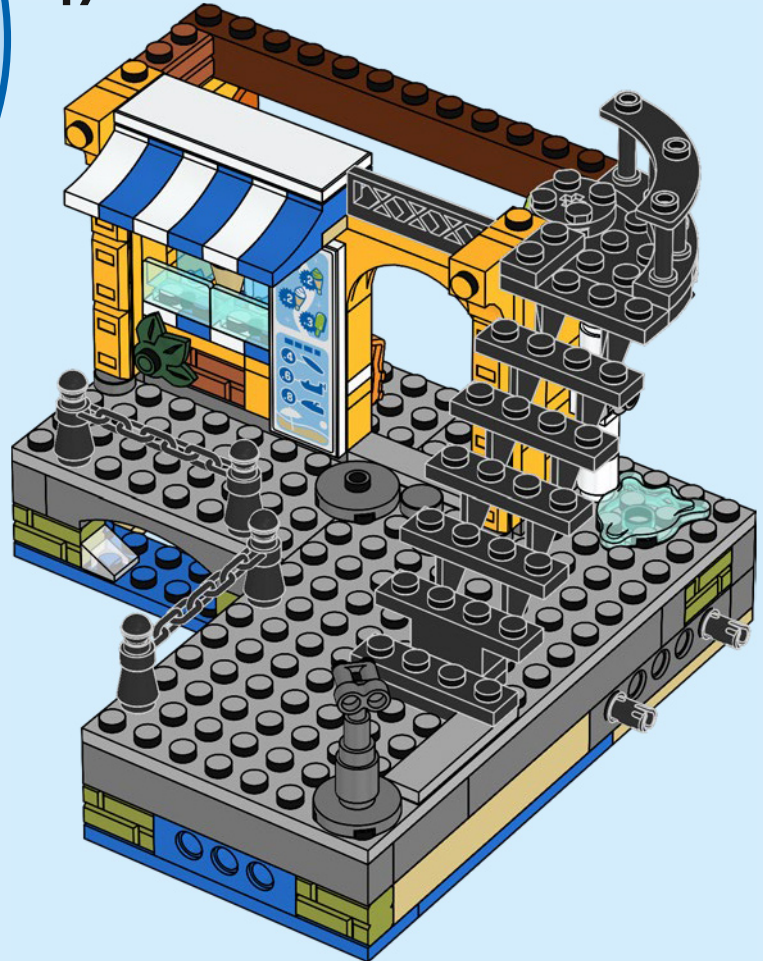



1x

48

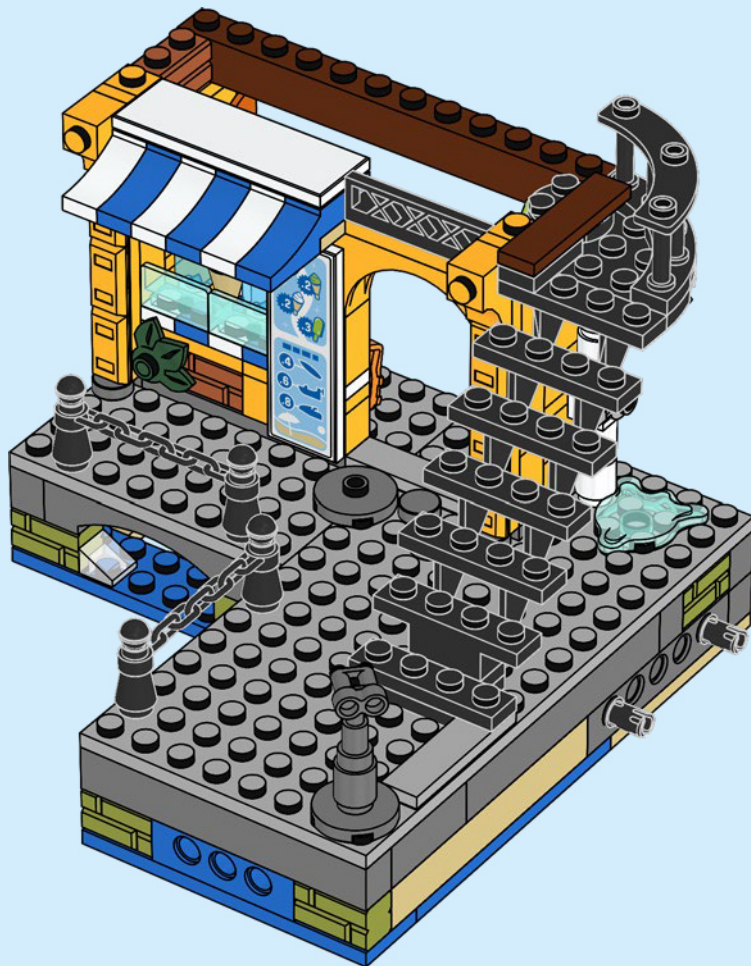

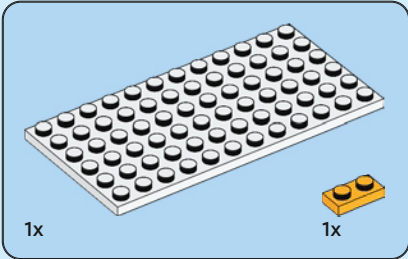
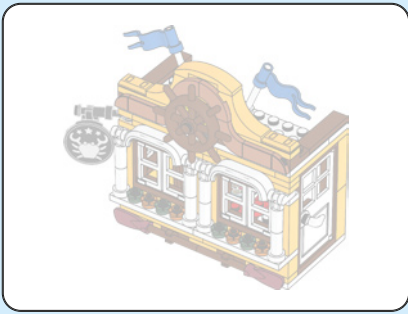

49

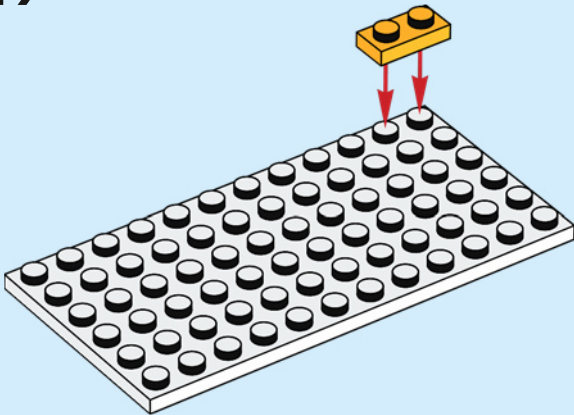

50

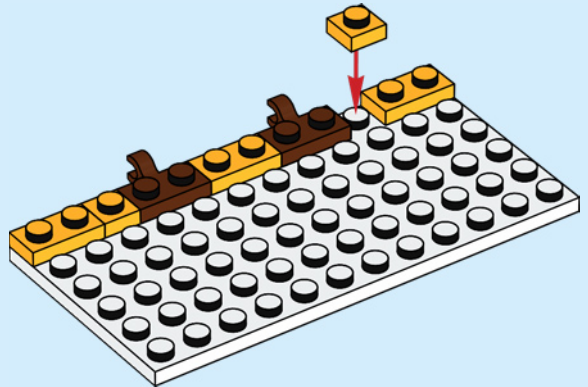

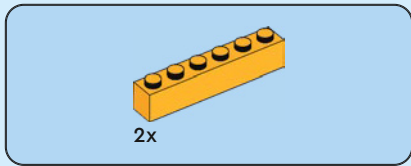

51

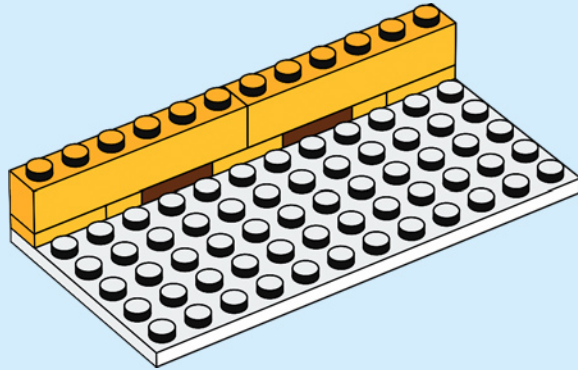



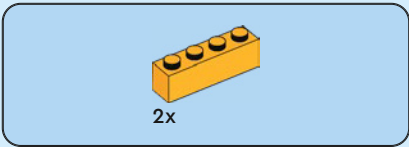

52

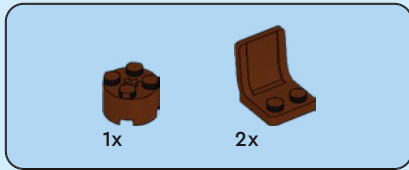
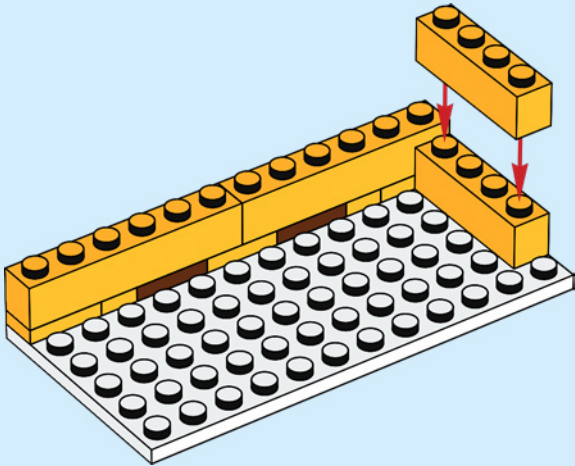

53

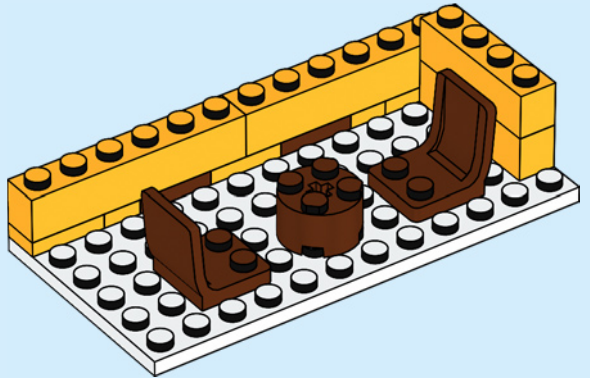

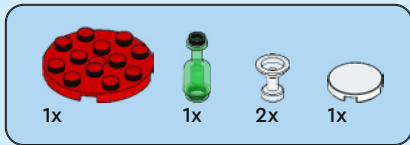

54

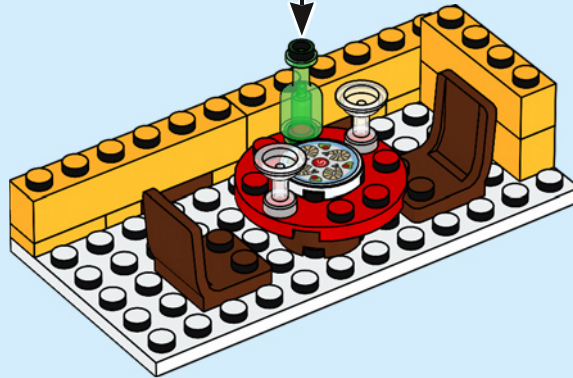
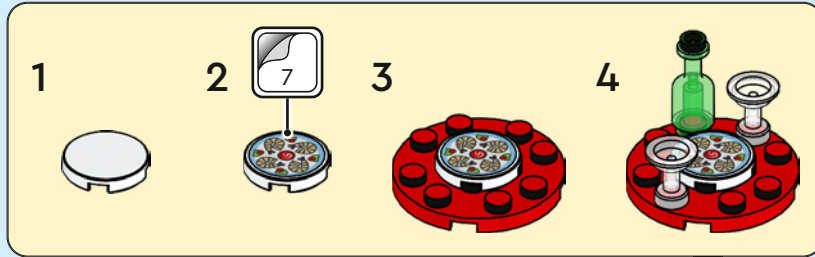

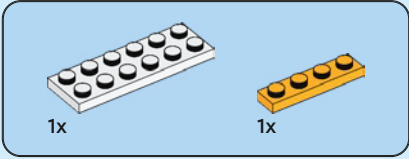

55

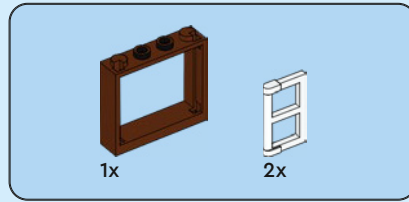
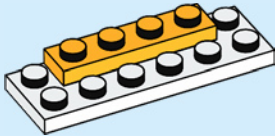

56

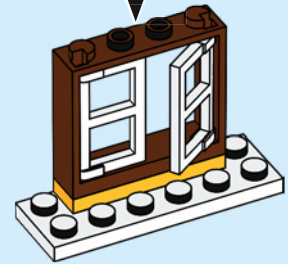
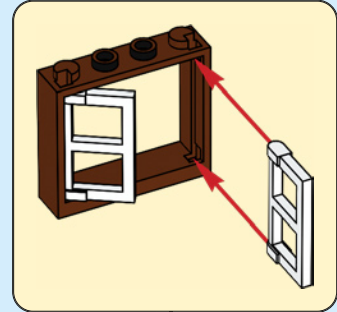



57

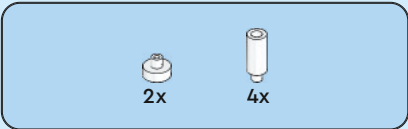
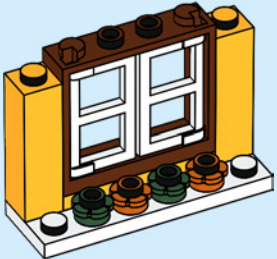

58

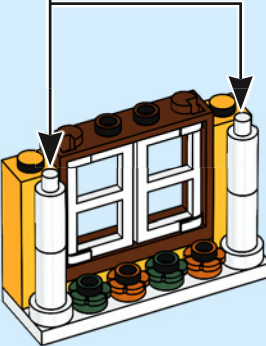
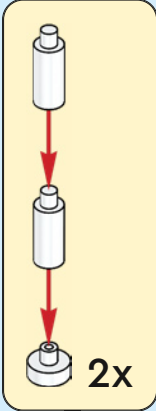



2x

59

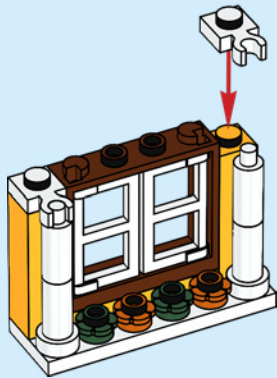

1x



2x

60

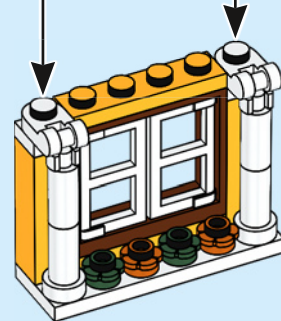



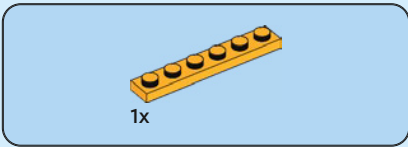

61

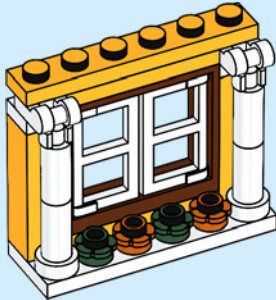

2x

62



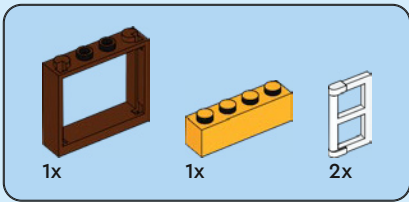

63

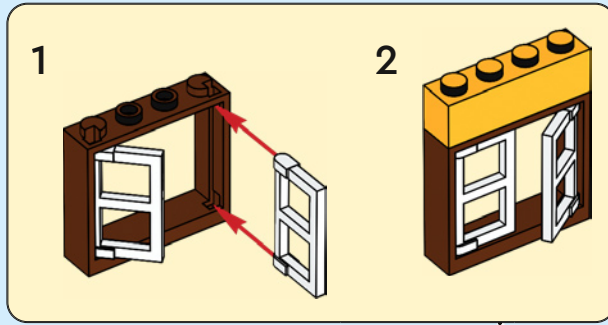

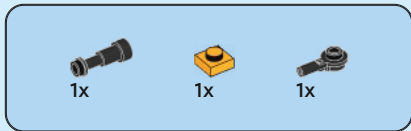

64

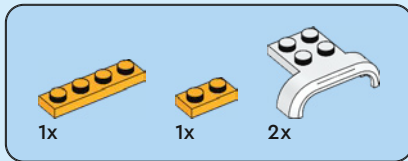
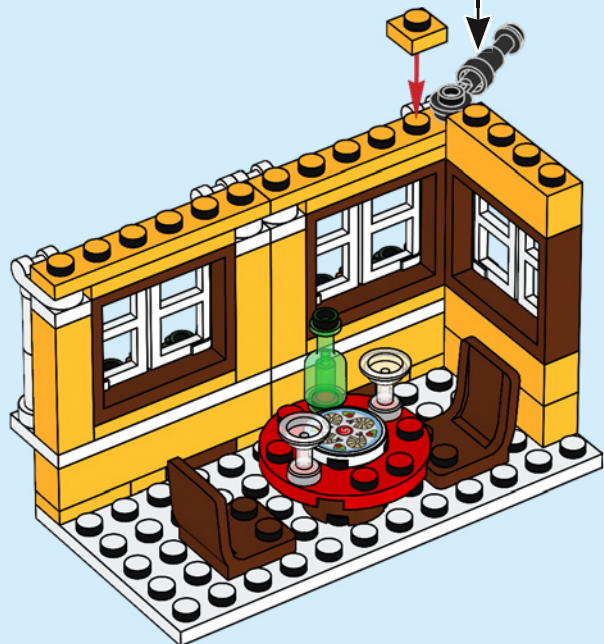
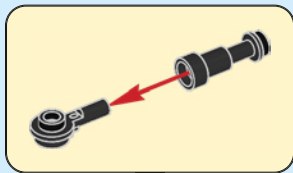

65



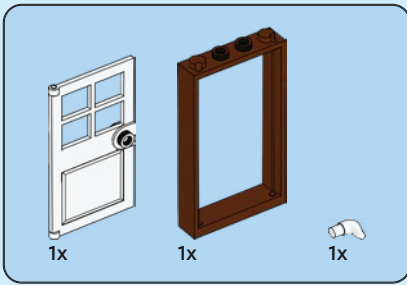

66

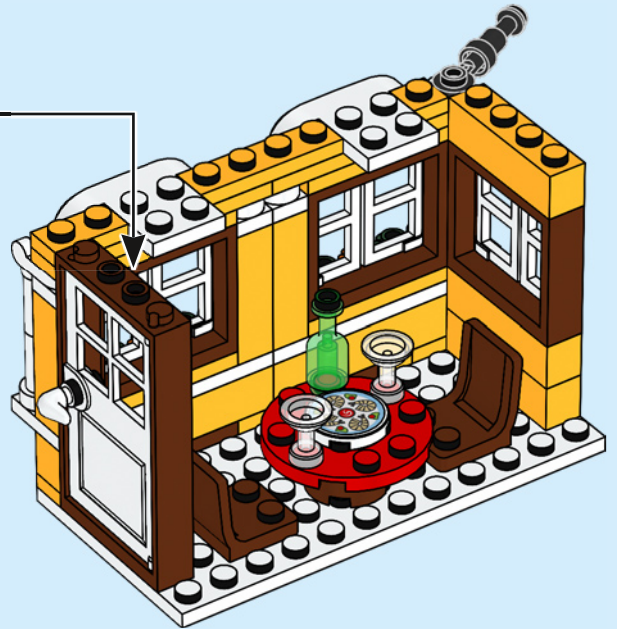
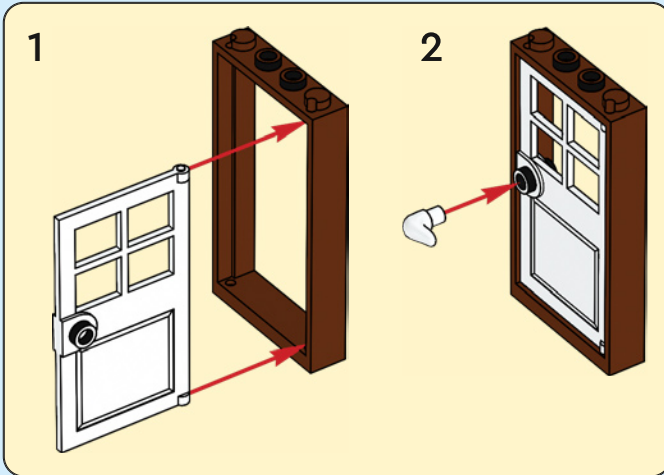

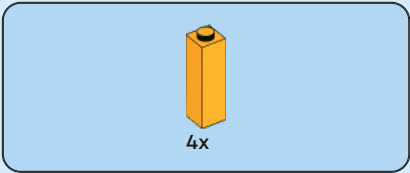

67

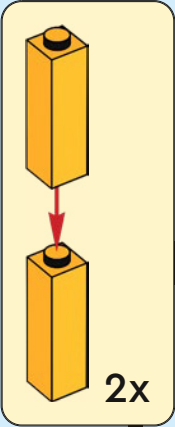



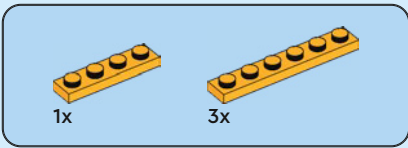

68

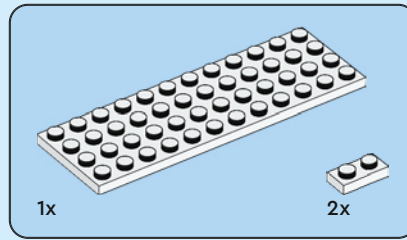

69





2x

70

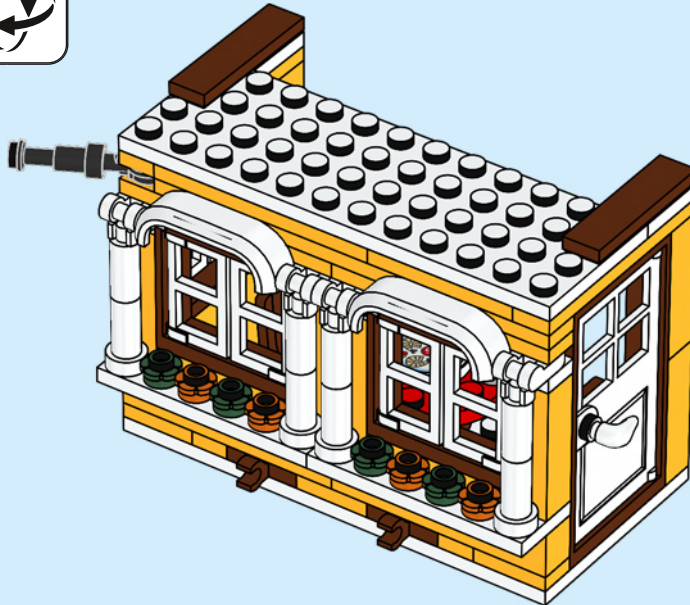



2x



4x

# 71

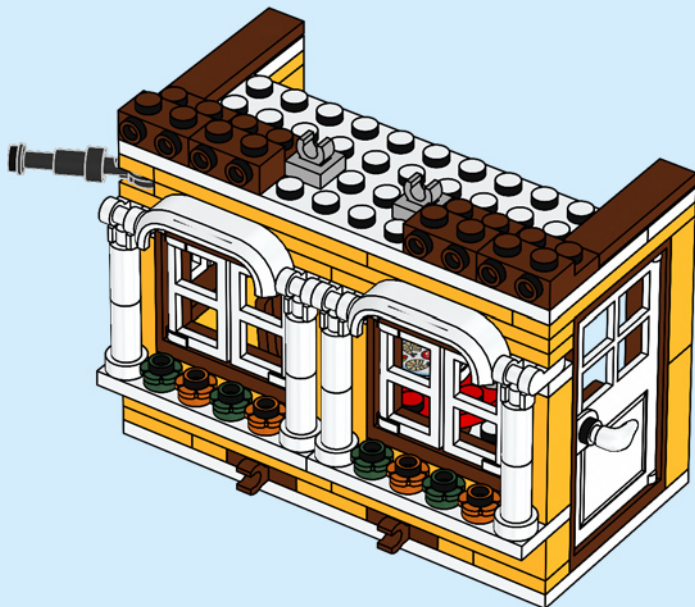



2x



2x

72

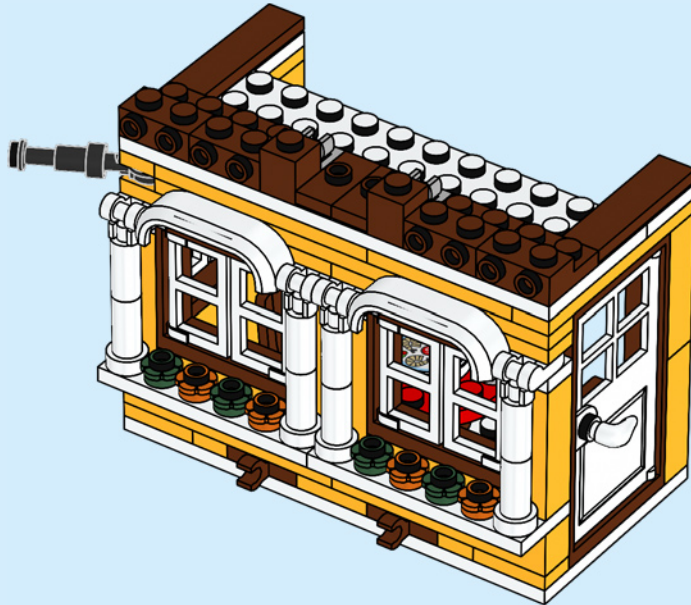

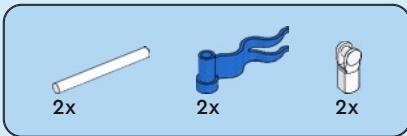

73

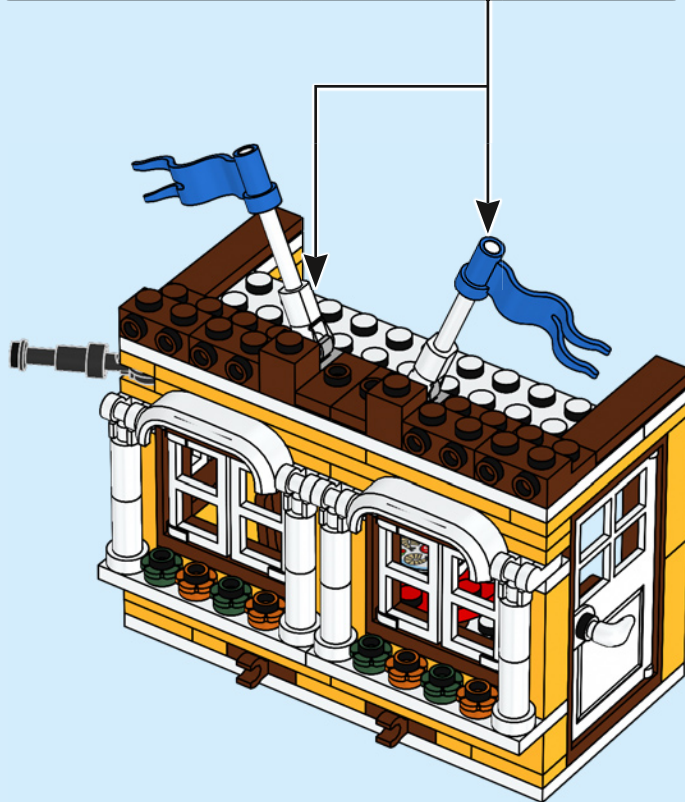
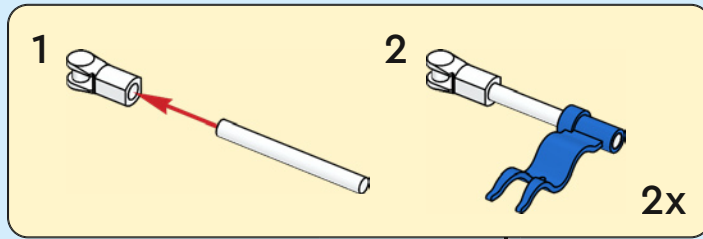





2x

74

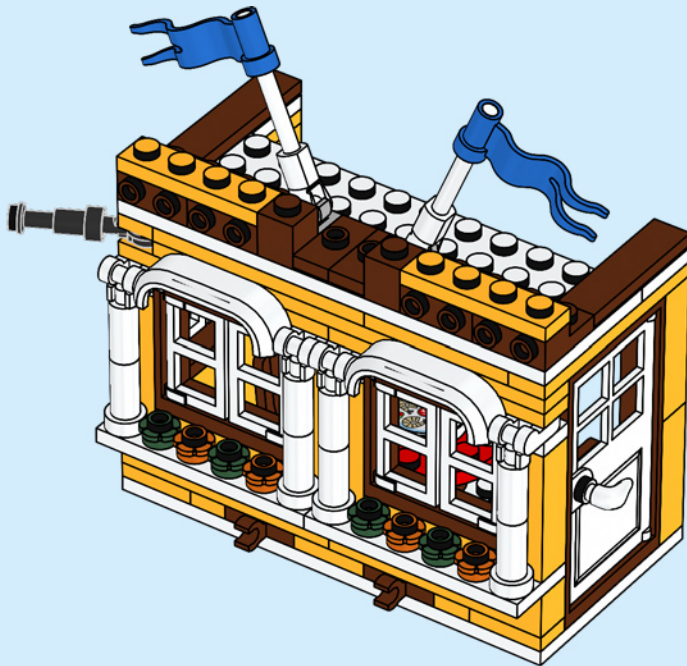

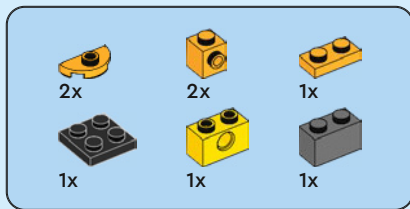

75

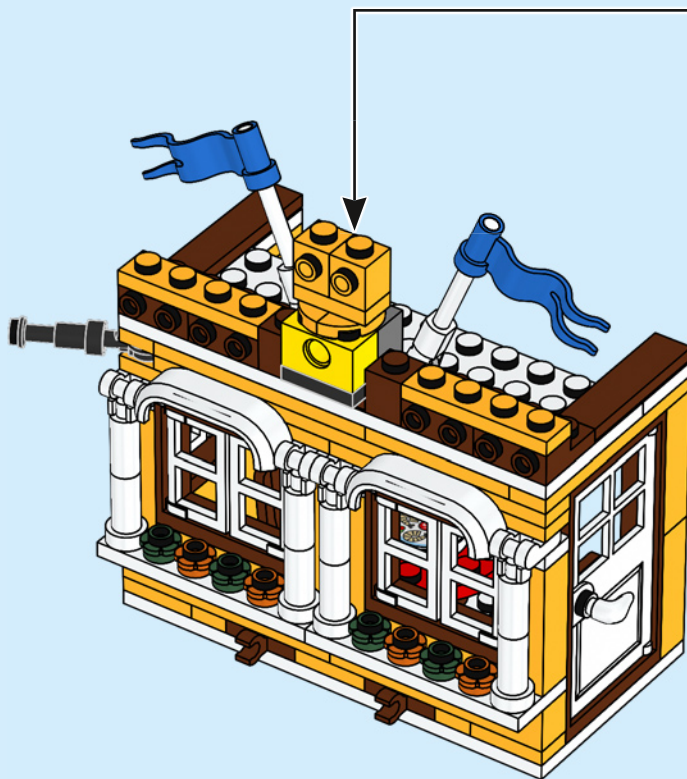
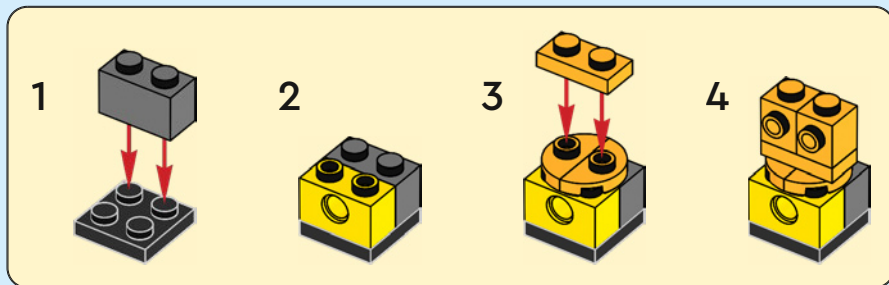

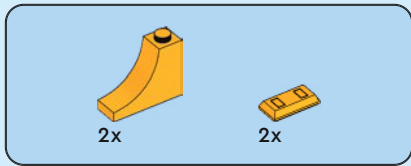

76

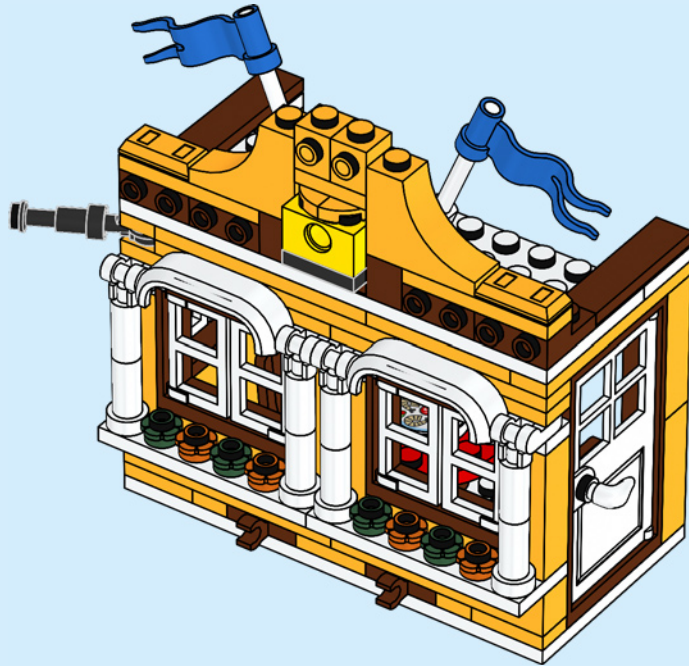



1x

77

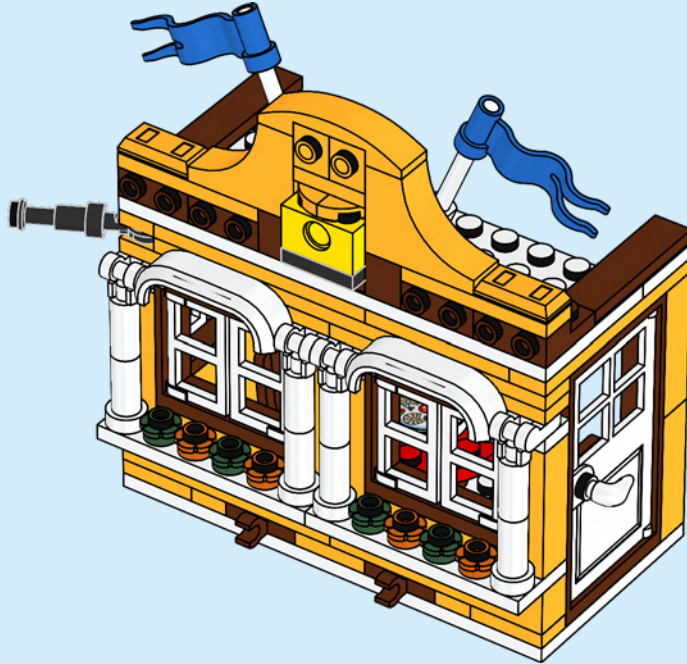



2x



2x



4x

78

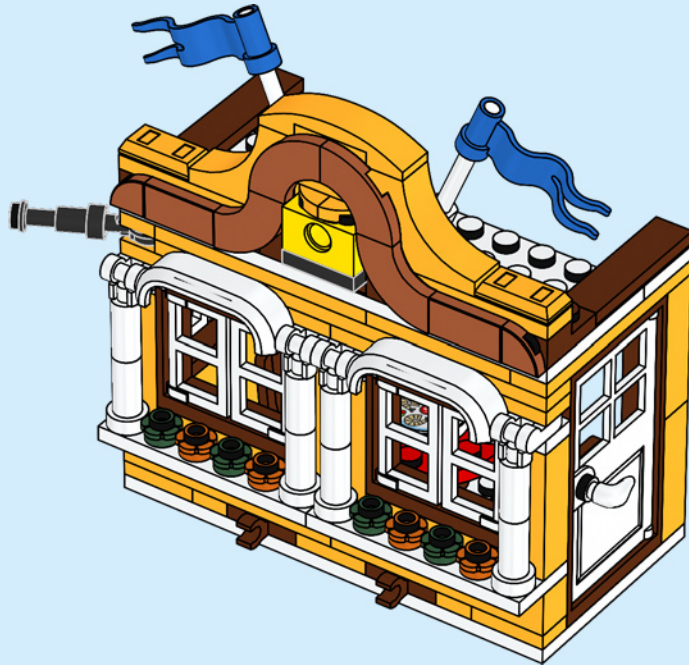





1x

79

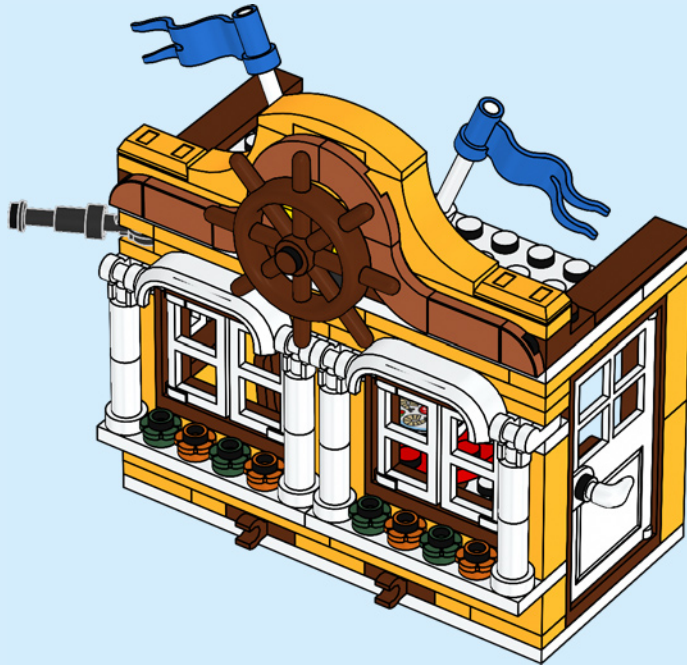

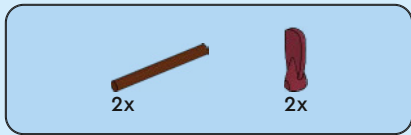

80

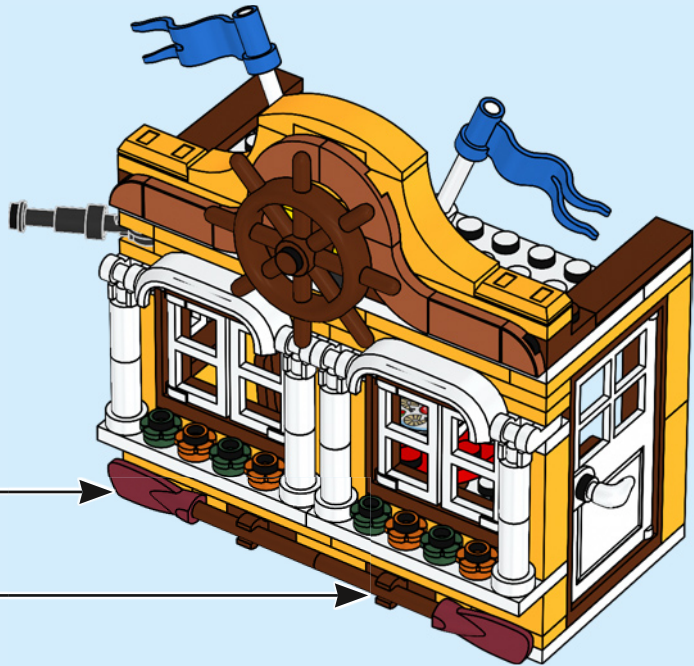
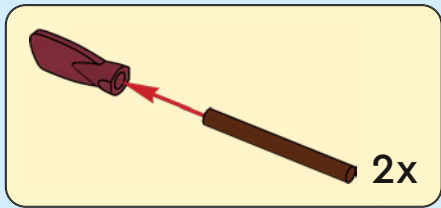

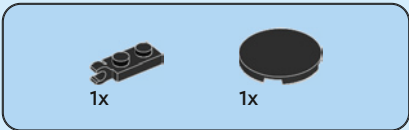

# 81

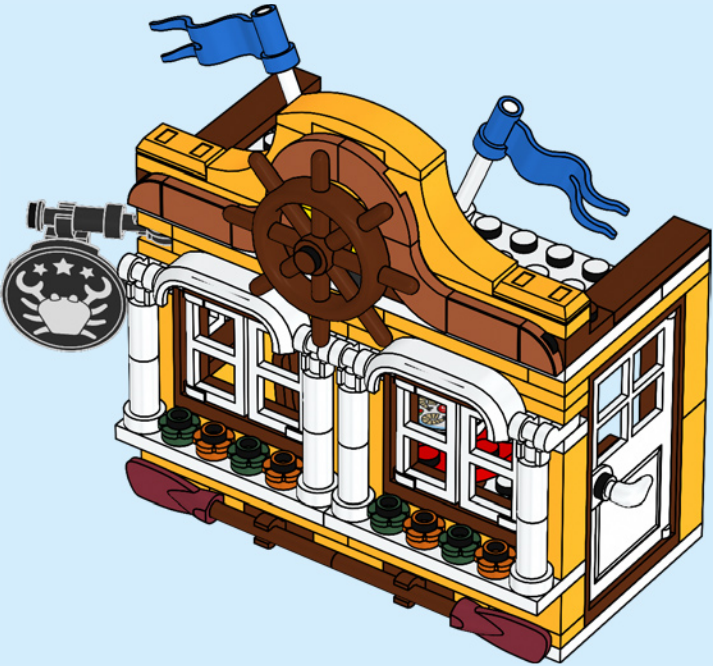
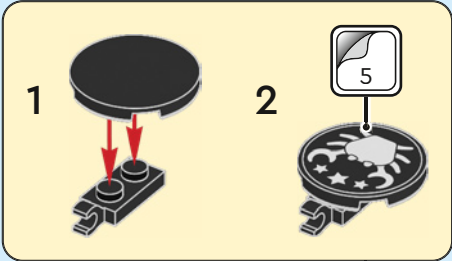

82



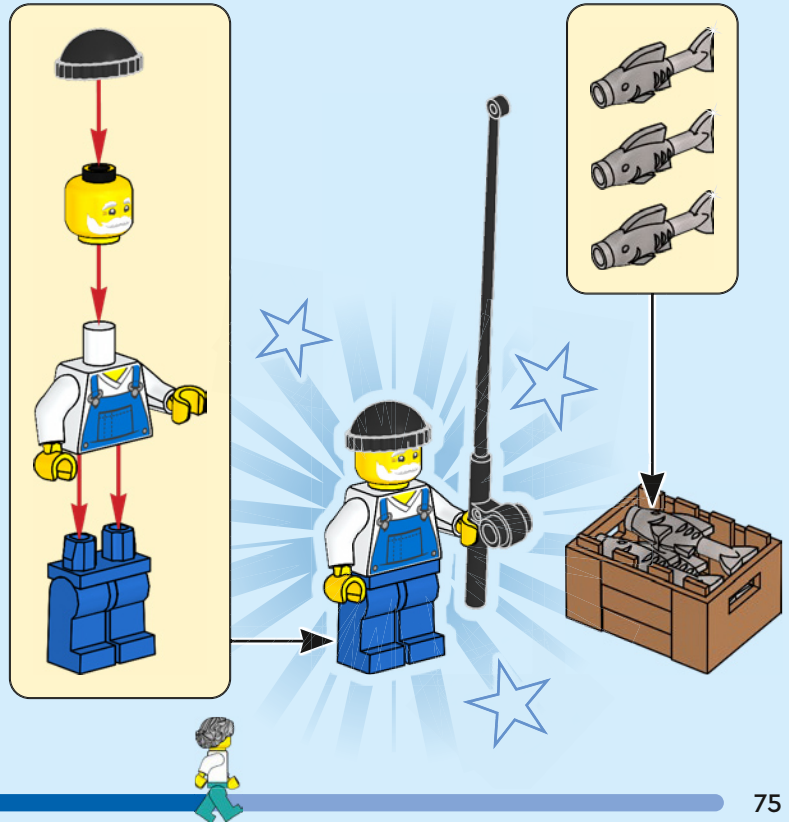
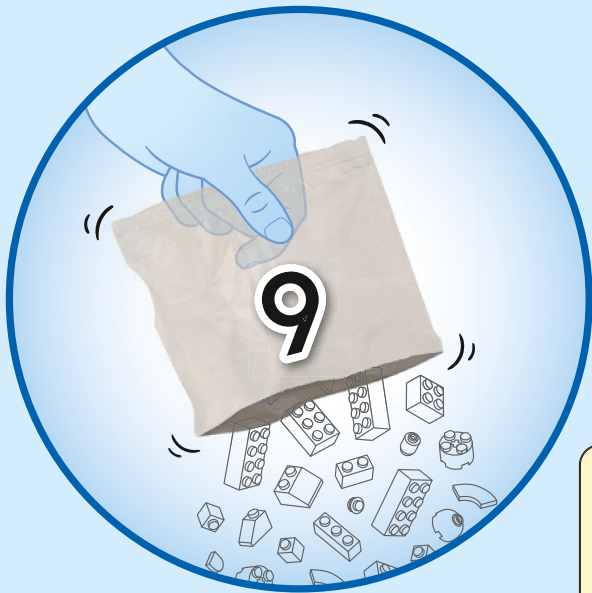

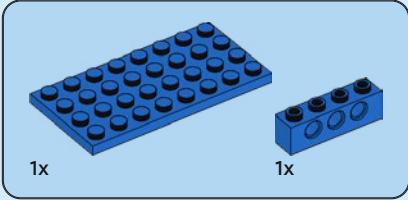
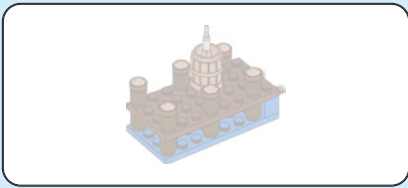

83

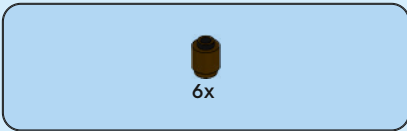
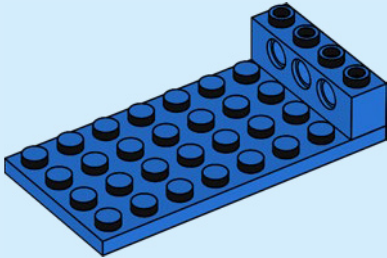

84

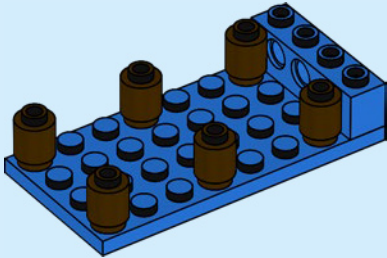



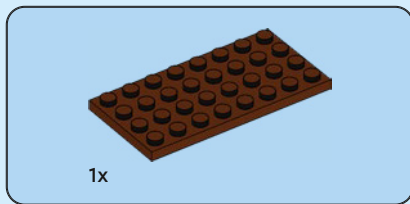

85

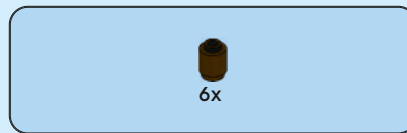
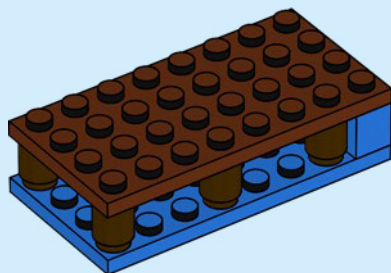

86

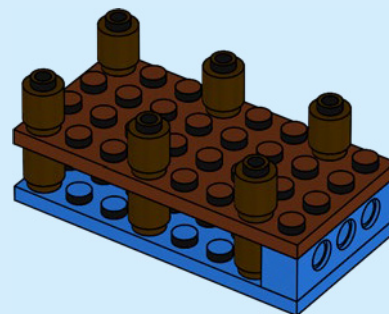



6x

87

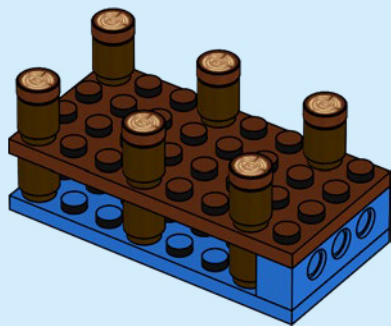

2x

88

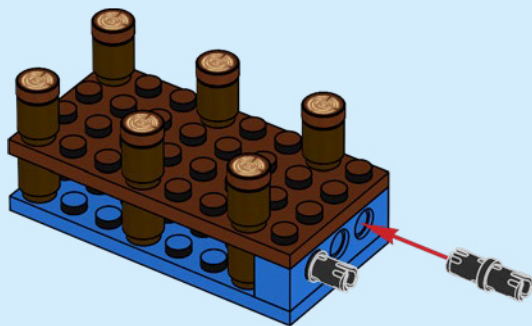

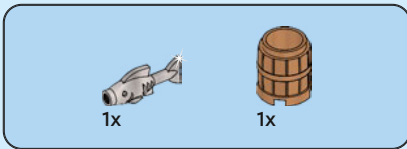

89

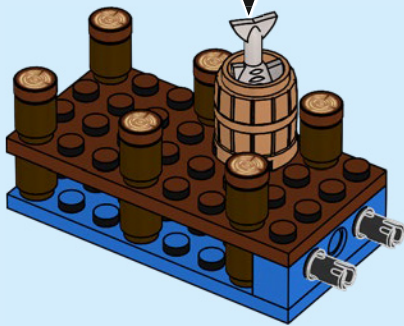
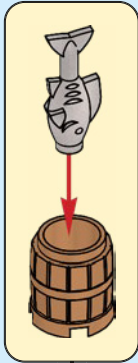

90



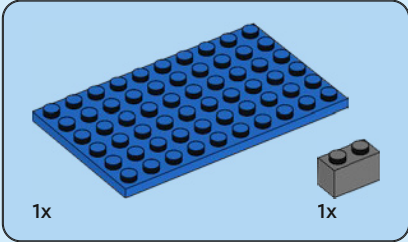
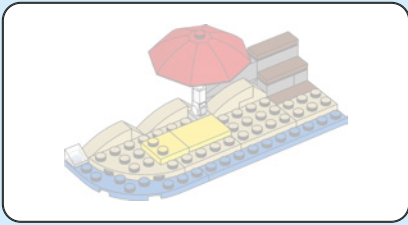

91

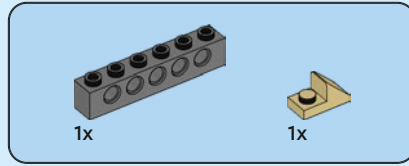
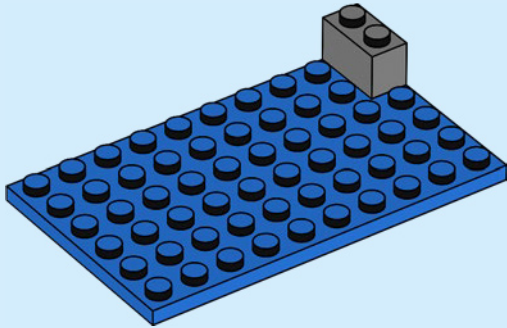

92

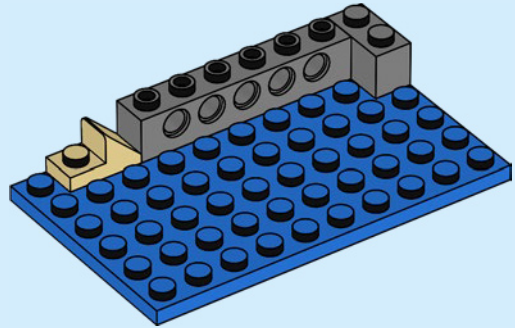

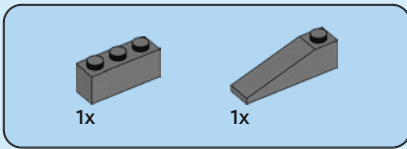

93

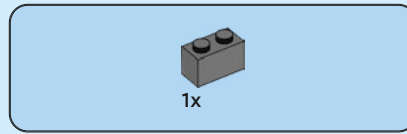
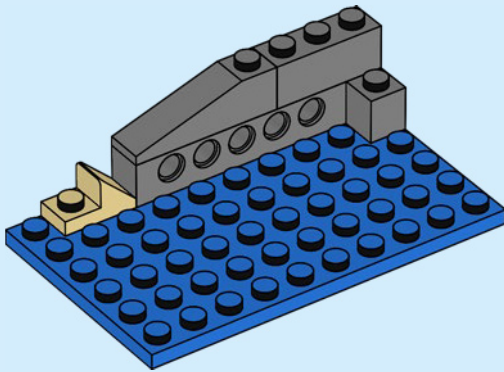

94

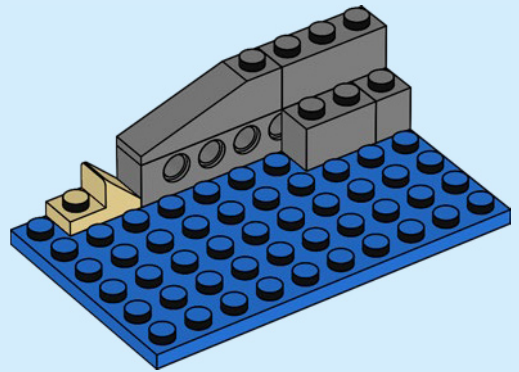

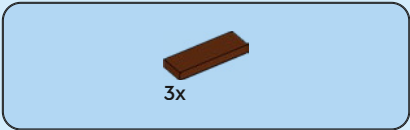

95

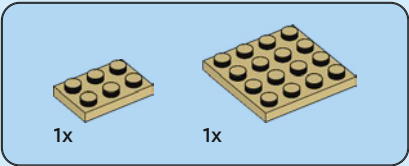
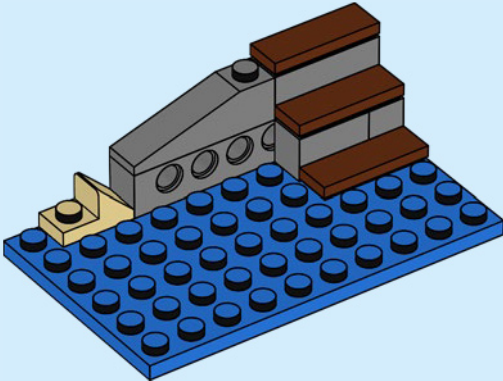

96

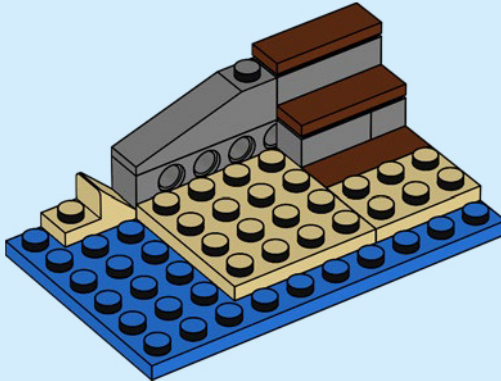



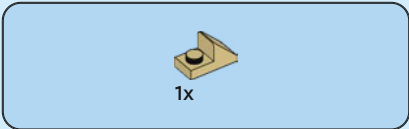

97

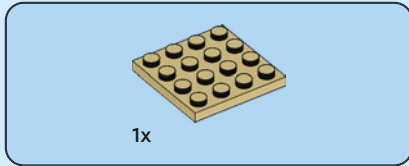
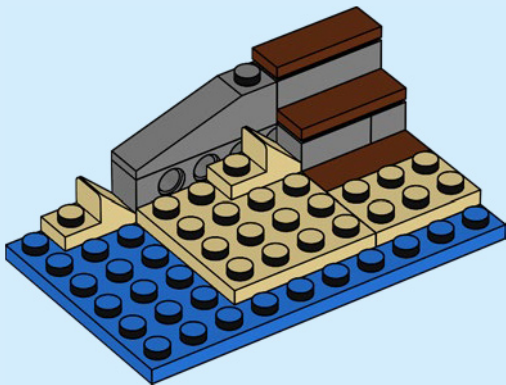

98

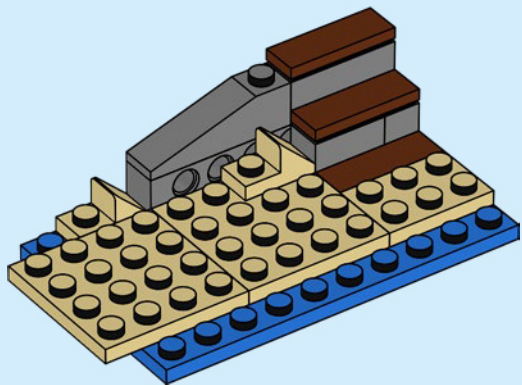

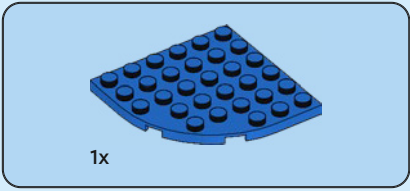

99

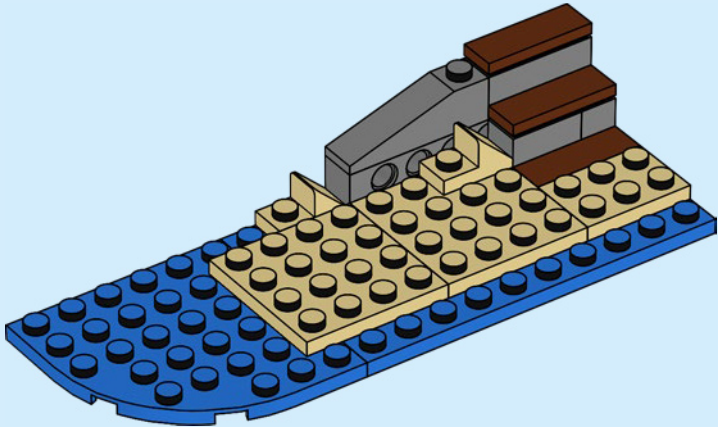



1x



1x

# 100

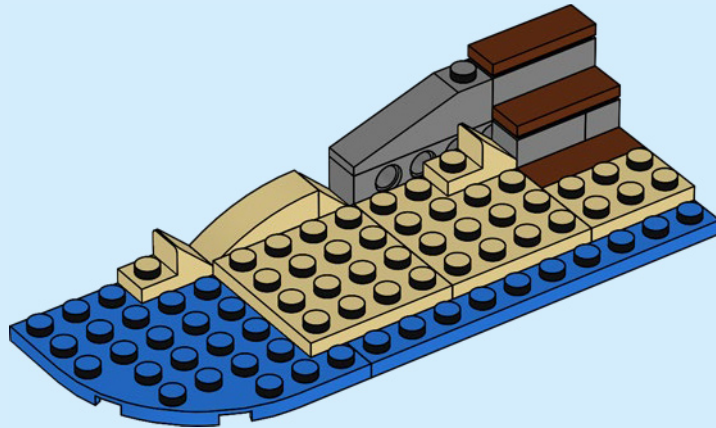

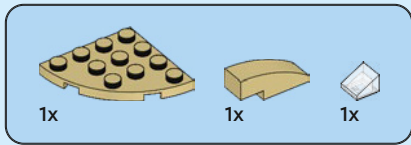

101

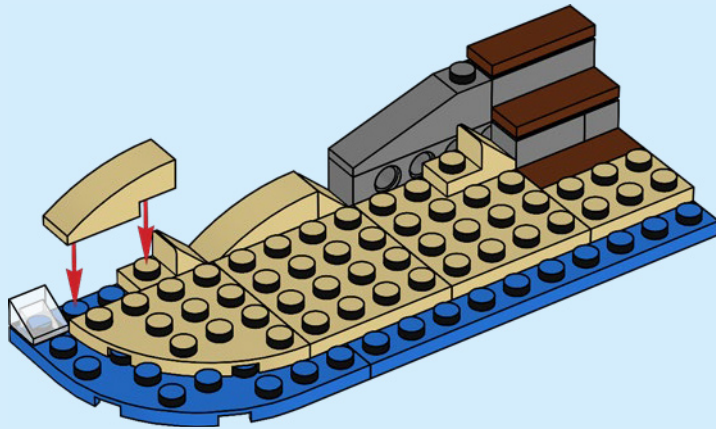



1x



1x

# 102

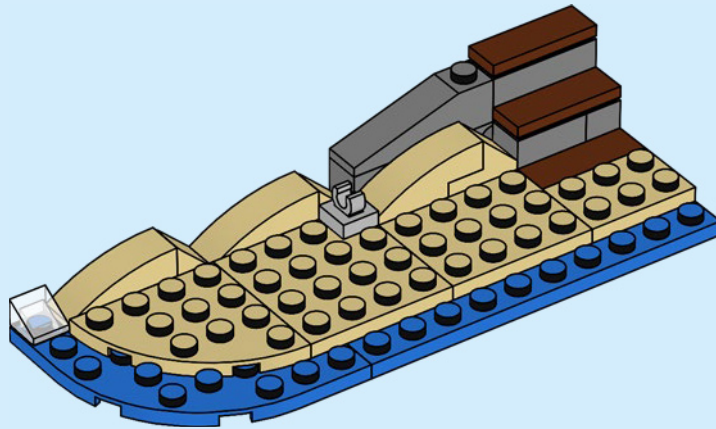

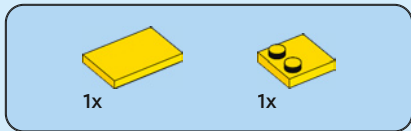

103

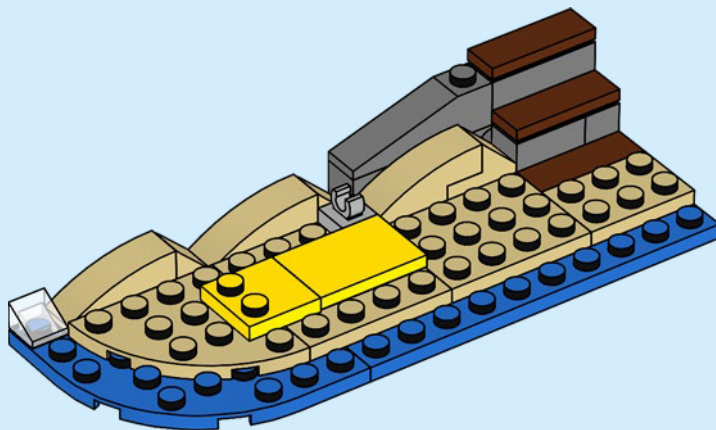



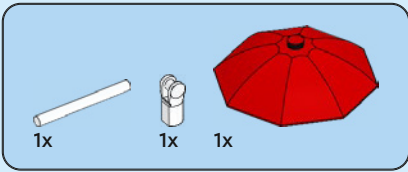

104

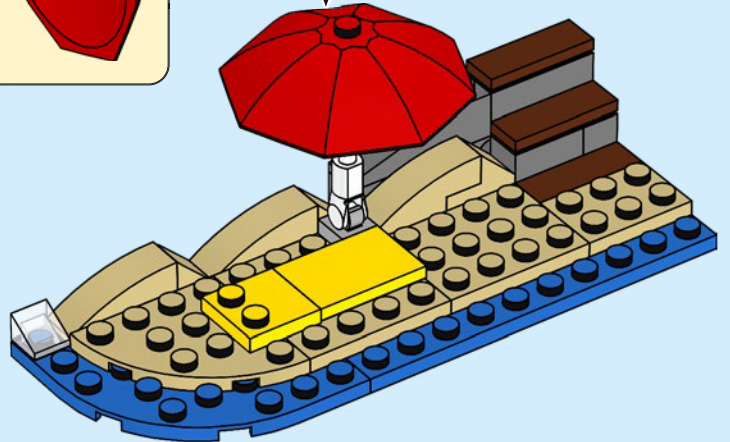
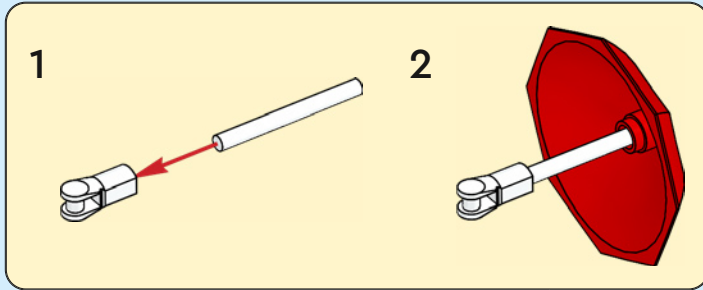

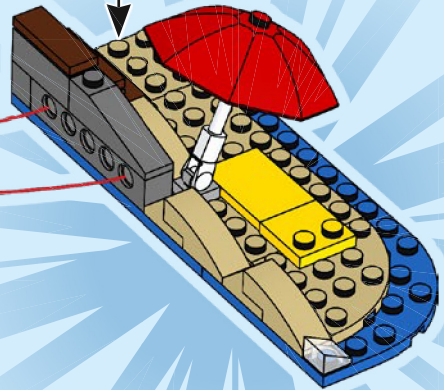
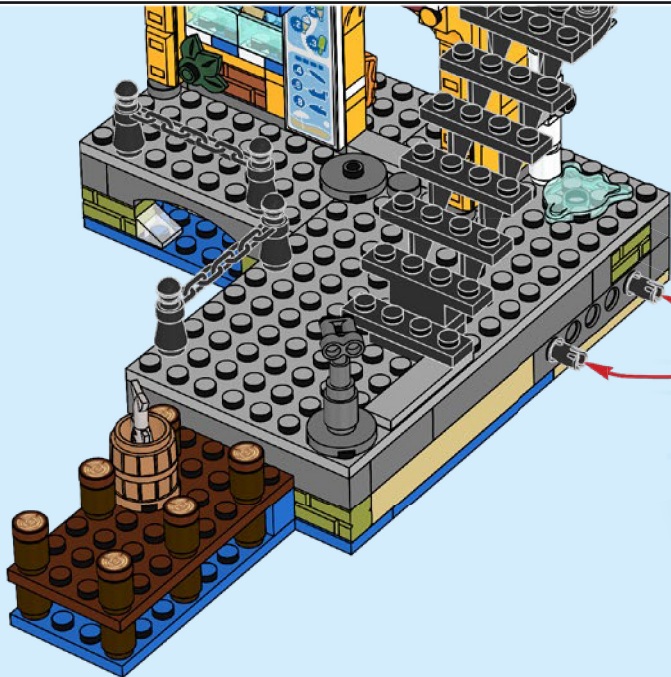
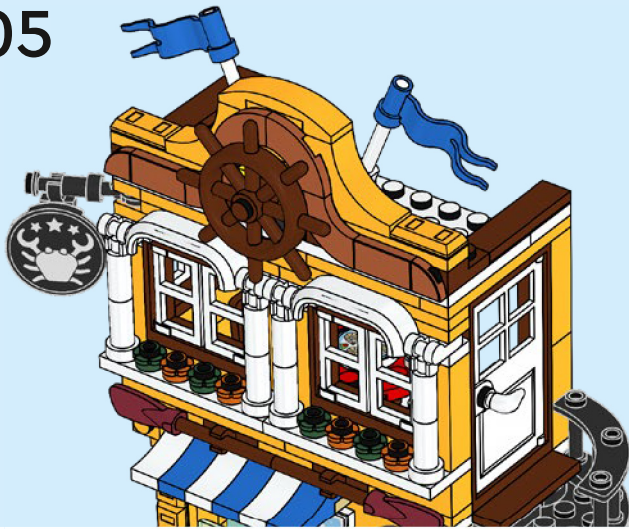







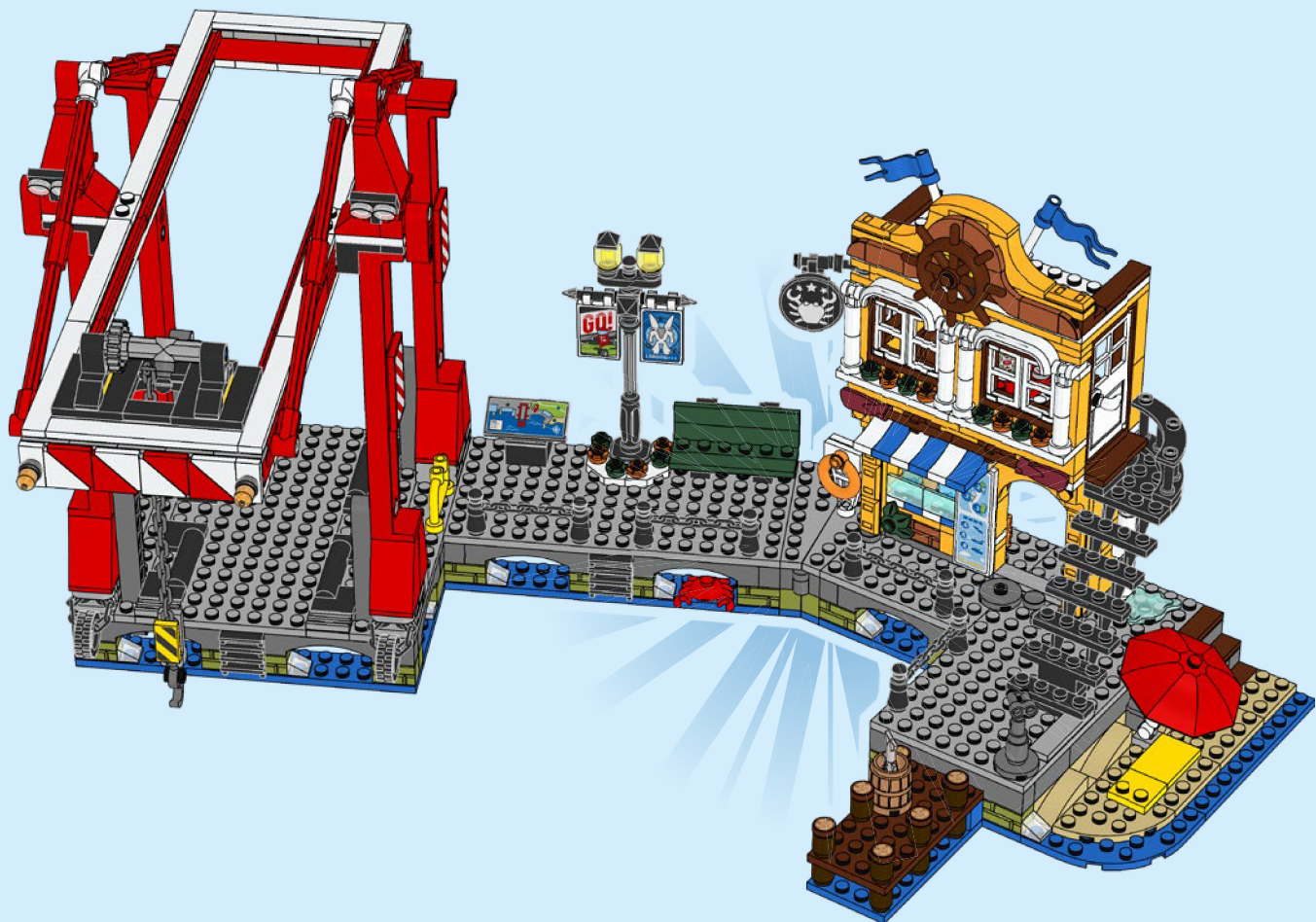

12x  
302401

1x  
6044691

2x  
300401



1x  
6108866



1x  
6287500



4x  
302001



1x  
4521943



6x  
6171058



1x  
6261349



2x  
6172927



7x  
6357598



4x  
6116602



15x  
6061047



2x  
6435932



1x  
6112193



2x  
6176240



5x  
6051511



2x  
362201



3x  
302101



1x  
4560178



2x  
6360131



1x  
6132203



1x  
6403257



10x  
6070698



2x  
4558168



6x  
371001



1x  
4243812



2x  
6252931



2x  
6055541



1x  
6132204



8x  
6217875



6x  
4568956



2x  
6034675



4x  
379501



1x  
6170524



2x  
4504369



2x  
6400114



6x  
6004491



1x  
6425508



2x  
6249091

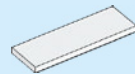

3x  
6332042



4x  
6058329



4x  
300501



2x  
6210272



2x  
6126046



1x  
6219621



3x  
4521846



2x  
4599044



2x  
6366391



4x  
6348055



7x  
6330191



2x  
302201



1x  
6268491



2x  
365901



10x  
416201



6x  
306901



2x  
407001



4x  
6174937



2x  
6218822



1x  
6270480



1x  
6289797



1x  
6483097



12x  
302301

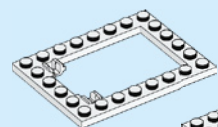

2x  
6054973

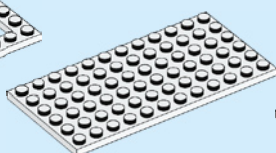

1x  
4120020

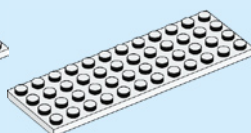

1x  
4168072

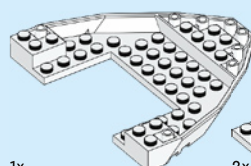

1x  
6486813

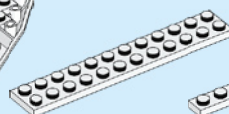

2x  
244501

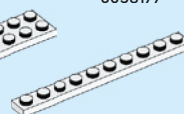

7x  
447701





1x  
6337079



8x  
6234807



2x  
614101



4x  
306201



2x  
6448949



5x  
6186681



1x  
6438901



1x  
6328195



8x  
6388018



3x  
6322489

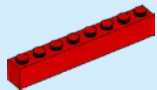

6x  
300821



8x  
6130004



1x  
300321



4x  
6480179



10x  
6007897



2x  
303921



2x  
306821



6x  
370021



8x  
6078594



1x  
6483104



4x  
6332580



2x  
6093950



4x  
4513174



1x  
6253363



4x  
302321



2x  
4207715



8x  
6351892



4x  
4140585



2x  
4153718



4x  
370121



1x  
303523



1x  
303221



1x  
4515348



4x  
4560179



4x  
366621



1x  
4649773



2x  
243123



6x  
370123



2x  
371023



3x  
379523



1x  
6093691



1x  
6339304



2x  
6432005



2x  
6352221



1x  
4206482



1x  
9341



1x  
6290532



3x  
306823



2x  
6299413



5x  
6439891



2x  
6268955



4x  
303423

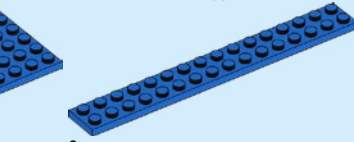

2x  
6481432



1x  
6429739



1x  
4651441



1x  
6328351



1x  
6352820



1x  
6288000



1x  
6039464



1x  
6369661



1x  
6312495



1x  
389924



2x  
302324



1x  
370024



1x  
6329649



4x  
4140587



4x  
242024



4x  
393724



1x  
300324



1x  
6224666



2x  
408324





















































1x  
6179184









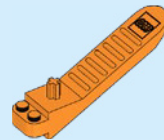

























































2x  
371024

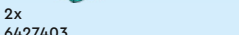

1x  
302024

 2x 6170545	 1x 6132809	 2x 4617848	 1x 300226	 2x 302026	 2x 6347310
 3x 6312449		 2x 6053077	 1x 6376695	 1x 6115198	 6x 302326
 4x 4504382	 2x 6285241	 3x 300326	 2x 6395375		 1x 393726
 1x 473326	 3x 6336989	 3x 302226	 1x 371026	 6x 6328408	 2x 4144024
 1x 6277468	 1x 6428168	 2x 6425507	 1x 4187209	 2x 6076678	 2x 306926
 1x 4157108	 1x 6170693	 8x 6133722	 4x 6370959	 4x 663626	 1x 6196548
 2x 6157554	 8x 242026	 5x 6192346	 1x 6438520	 2x 4620763	 1x 4538456
 2x 4548180	 8x 303926	 1x 9551	 2x 4515368	 1x 6101857	 3x 6020193
 13x 4278359	 1x 6007896	 1x 400626	 1x 4560182	 1x 6399751	 3x 6313116
 1x 403226	 1x 4618852	 1x 4279270	 2x 6396288	 2x 6263971	 26x 6279875
 2x 6010831	 2x 241226				 1x 243226
 2x 4644456					 1x 6240515

 2x 6210496	 1x 6400754	 3x 4624088	 1x 6364438	 4x 6340042	 6x 6285623
 10x 6088550	 2x 6484030	 1x 4118790	 1x 6334219	 2x 6228968	 1x 6438899
 2x 6321194	 4x 4245570	 2x 4114309	 2x 6017003	 1x 4211186	 2x 4211242
 10x 6168646	 3x 6013102	 2x 4243824	 3x 6069165	 1x 6278548	 1x 6491486
 8x 4529236	 2x 6391596	 1x 4570516	 6x 6330903	 3x 4211194	 1x 4211166
 1x 6270122	 8x 6486808	 5x 4113993	 1x 6205345	 2x 6116613	 1x 6223059
 7x 6446790	 3x 4245566	 1x 4159774	 1x 6205345	 3x 4595889	 2x 4221886
 4x 4521915	 8x 6486791	 1x 4114001	 1x 6397830	 1x 6262952	 2x 6092590
 2x 6055169	 3x 6216880	 2x 4113988	 2x 6314383	 4x 6470170	 2x 6313124
 3x 6486789	 2x 6215657	 2x 6427403	 2x 4614158	 1x 4222627	 2x 4211206
 2x 6337306	 2x 6337306	 2x 6427403	 1x 4211207		 3x 6100769

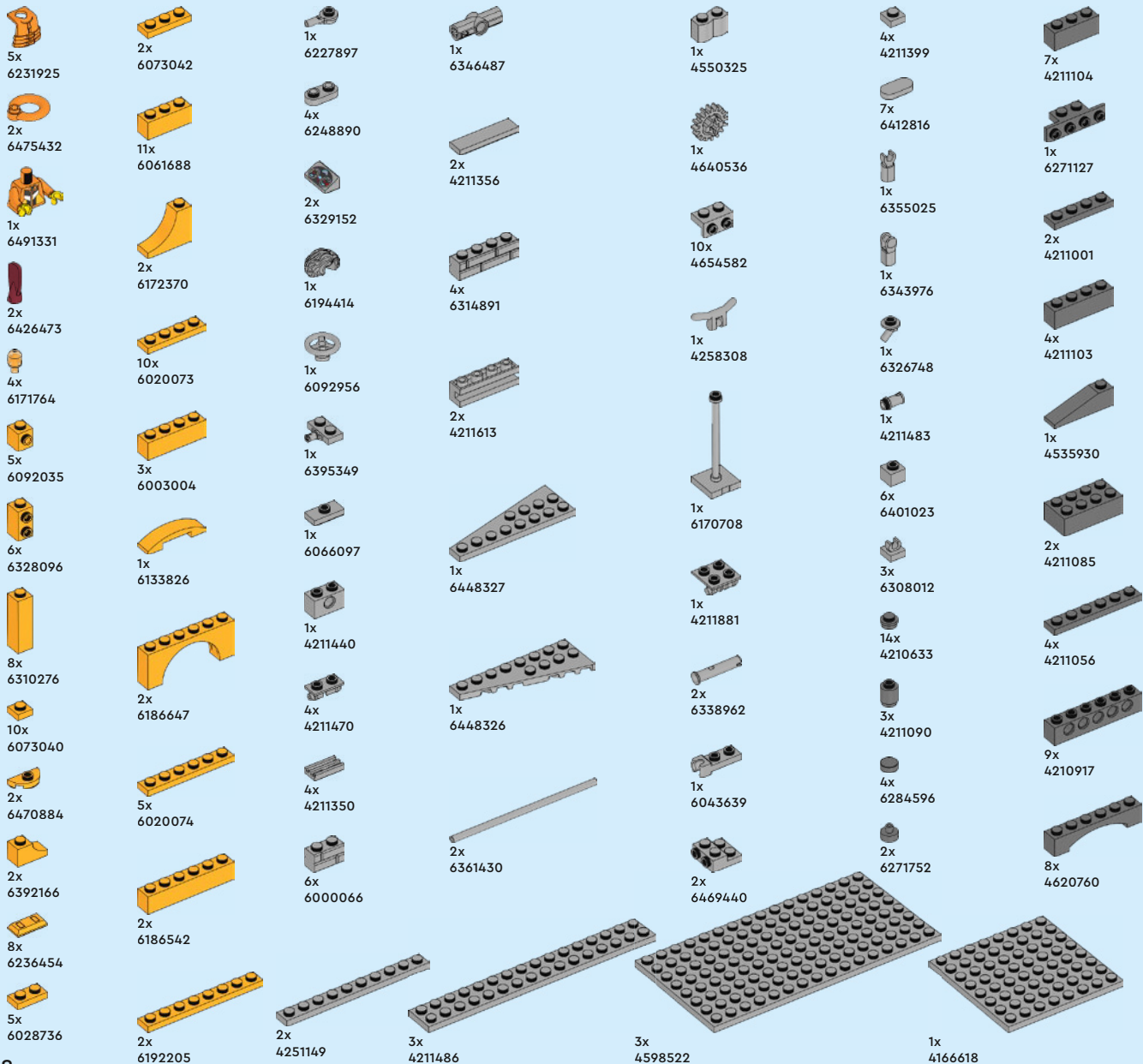



1x  
4211039



8x  
4211111



2x  
6115080



2x  
4211098



4x  
4211063



2x  
6331222



1x  
4211051



1x  
4210795



1x  
6347464



1x  
4211109

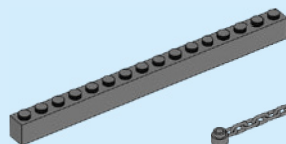

5x  
4210783



2x  
6360111



1x  
6395635



3x  
4211088



1x  
6327414



1x  
6396412



12x  
6022105



1x  
6333518



1x  
6365629



1x  
6035734

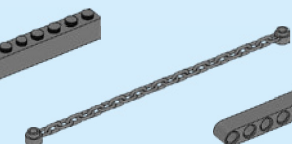

1x  
6258887



12x  
6274738



2x  
6454463



7x  
6245250



1x  
6277460



6x  
6251294



1x  
6258607



1x  
6252042



2x  
6267057



2x  
6300208



1x  
6274742



1x  
6247364



1x  
6252046

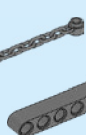

4x  
4645730



2x  
6246890



1x  
6373590



6x  
6254563



1x  
6245307



2x  
4537251



2x  
6069006



1x  
6023954



1x  
6102906



1x  
4267425



1x  
4162916

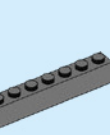

2x  
4211099



1x  
6253187



1x  
6329604



8x  
6215447



4x  
4611885



1x  
6031019



1x  
6029933



7x  
6058242



16x  
6469108



3x  
6058220



2x  
6390087



1x  
6471300

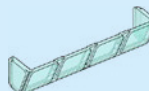

1x  
6483096



4x  
6467485



4x  
6469085

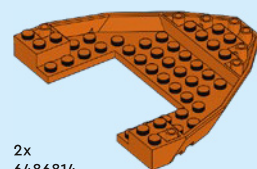

2x  
6486814

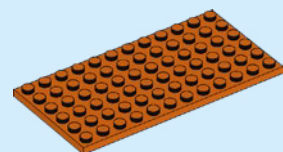

1x  
6482851

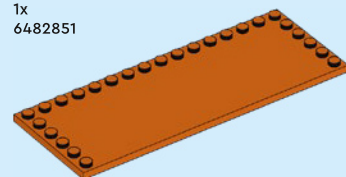

2x  
6488728



1x  
6470072



7x  
6475523



8x  
6466720



 [LEGO.com/service](https://www.LEGO.com/service)

YOU COULD **WIN**



Scan this QR code or go to  
**LEGO.COM/PRODUCTFEEDBACK** and give  
us your short feedback about this LEGO®  
set for a chance to win a cool LEGO prize.

Terms and Conditions apply\*

**EN: YOU COULD WIN.** Terms and Conditions apply\* **DE: Du könntest GEWINNEN.** Es gelten die Teilnahmebedingungen\* **FR: Tu pourrais GAGNER.** Des conditions s'appliquent\* **IT: Potresti VINCERE tu.** Termini e condizioni sono applicabili\* **ES: Puedes GANAR.** Aplican términos y condiciones\* **PT: Poderá GANHAR.** Aplicam-se termos e condições\* **ZH: 轻松获奖. 条款和条件适用\*** **PL: Szansa na WYGRANĄ.** Obowiązują warunki korzystania\* **CS: Máte šanci VYHRÁT.** Platí všeobecné smluvní podmínky\* **SK: Máte šancu VYHRAŤ.** Platia všeobecné zmluvné podmienky\* **HU: TE IS NYERHETSZ.** Felhasználási feltételek érvényesek\* **RO: Ai putea CÂȘTIGA.** Se aplică termeni și condiții\* **BG: Можете да СПЕЧЕЛИТЕ.** Има определени правила и условия\* **LV: Tu vari LAIMĒT.** Ir spēkā noteikumi un nosacījumi.\* **ET: Sul on võimalus VÕITA.** Kehtivad tingimused\* **LT: Jūs galite LAIMĖTI.** Taikomos sąlygos\*

\*[LEGO.com/productfeedback-terms](https://www.lego.com/productfeedback-terms)