



MARVEL

76291



LEGO® Builder



LEGO.com/sustainable-packaging



FR

**DONNEZ
OU
RECYCLEZ**



OU



OU



ASSOCIATION MAGASIN DÉCHÈTERIE

Adresses sur quefairedemesdechets.fr

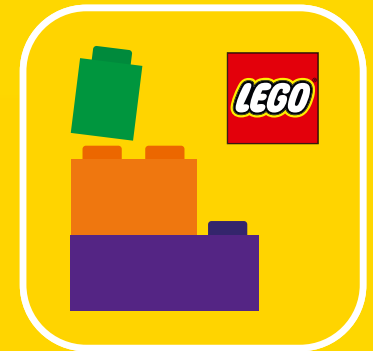

🔍 LEGO® Builder

BUILDER



Apple and the Apple logo are trademarks of Apple Inc., registered in the U.S. and other countries and regions. App Store is a service mark of Apple Inc. Google Play and the Google Play logo are trademarks of Google LLC. Tencent and the Tencent logo are trademarks of Tencent Inc.

🔍 LEGO.com/devicecheck

EN Ask parents' permission before going online | DE Eltern um Erlaubnis bitten, bevor du online gehst | FR Demande l'autorisation d'un parent avant d'aller en ligne | IT Chiedi il permesso ai tuoi genitori prima di andare online | ES Pídeles permiso a tus papás antes de conectarte a Internet | PT Peça autorização aos pais antes de acederes online | ZH 上网前应先征得父母的同意 | PL Poproś rodziców o zgodę, zanim wejdiesz do Internetu | CS Než půjdeš na internet, požádej rodiče o svolení | SK Skôr než pôjdeš na internet, vypýtaj si povolenie od rodičov | HU Kérj szülői engedélyt, mielőtt online csatlakoznál! | RO Cere permisiunea părinților înainte de a te conecta online | BG Поискайте разрешение от родител, преди да влезете онлайн | LV Pirms došanās tiešsaistē palūdz atļauju vecākiem | ET Enne Interneti kasutamist küsi vanematelt luba | LT Prieš prisijungdami prie interneto, atsiklauskite tėvų

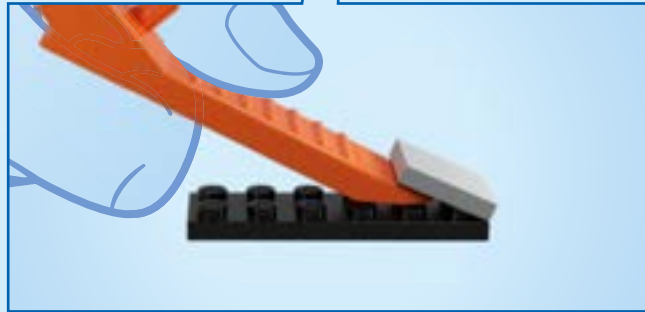
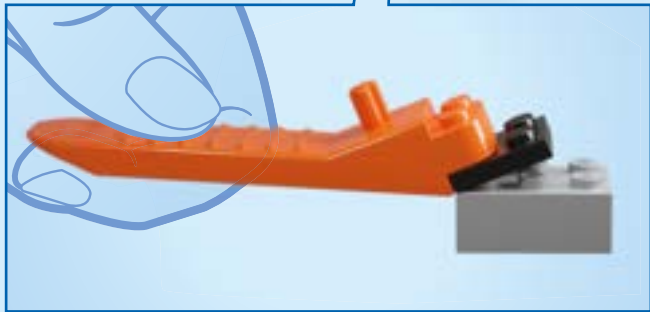
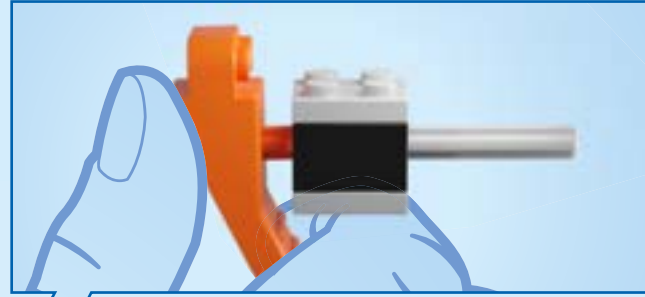

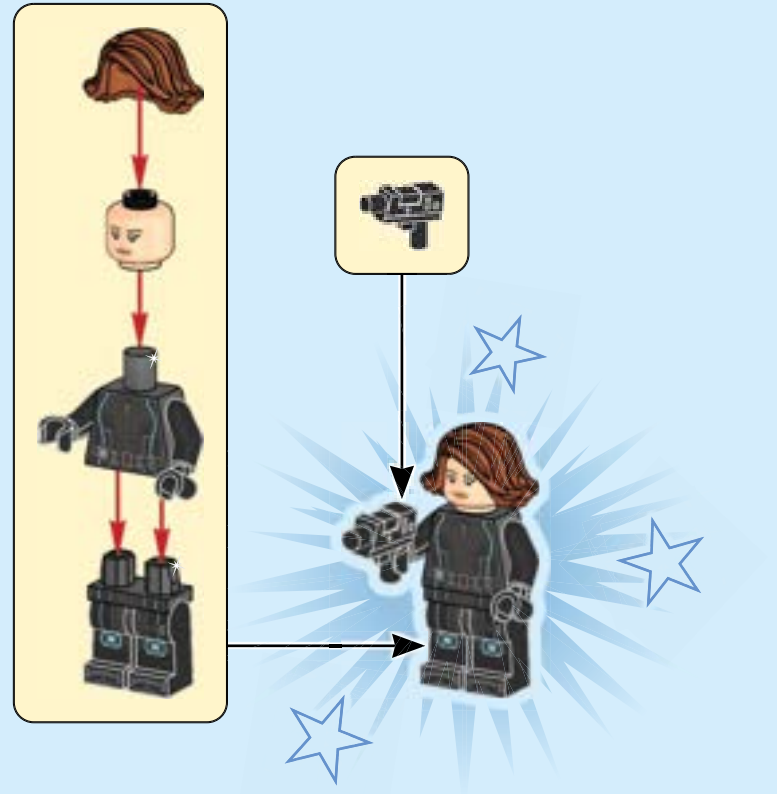

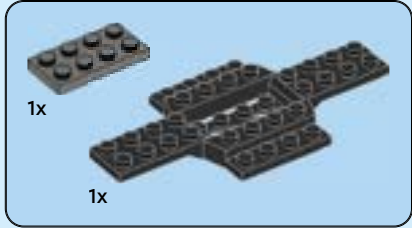
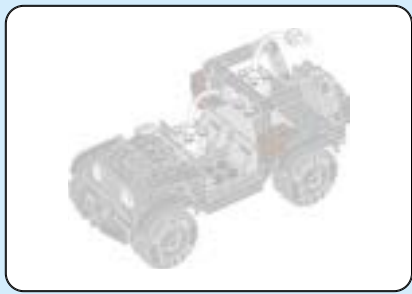

1



2

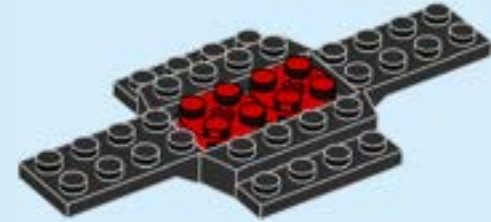

3

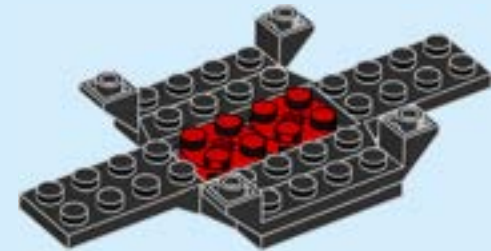



4

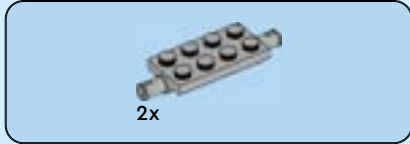

5

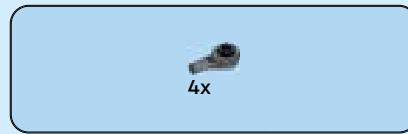
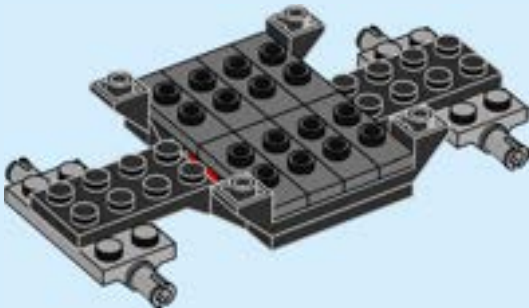

6

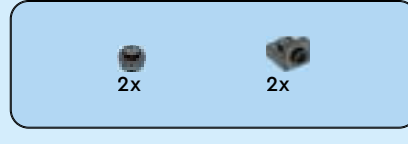
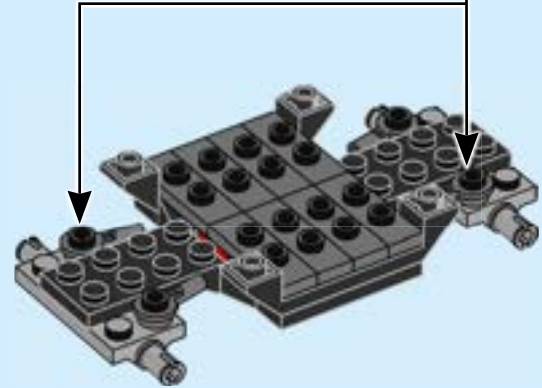

7

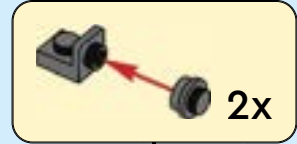
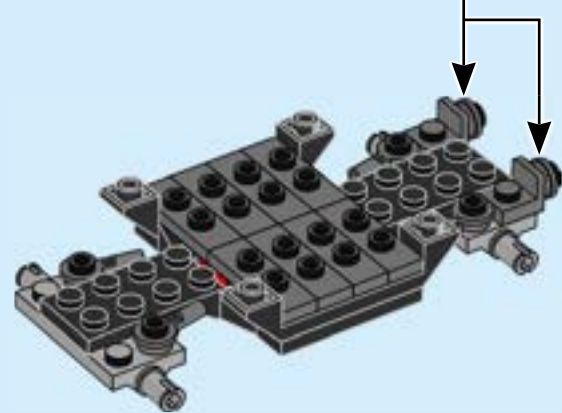

2x

8



9

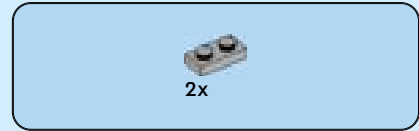
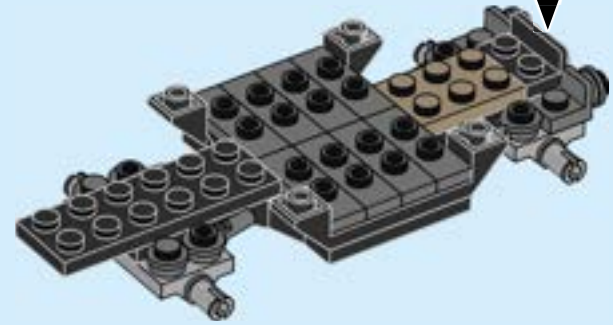

10

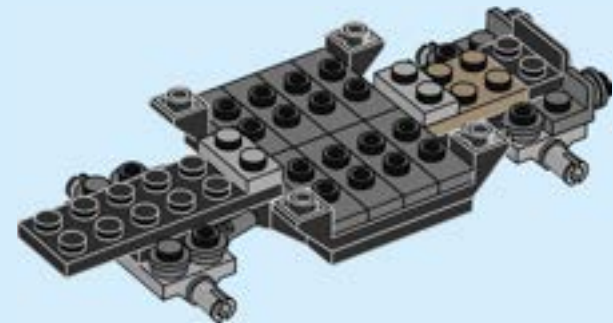

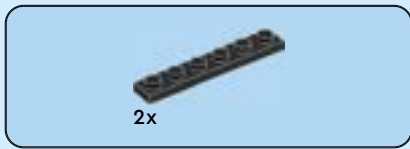

11

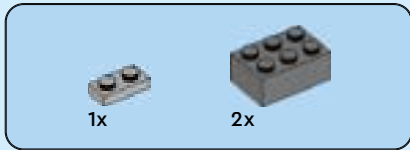
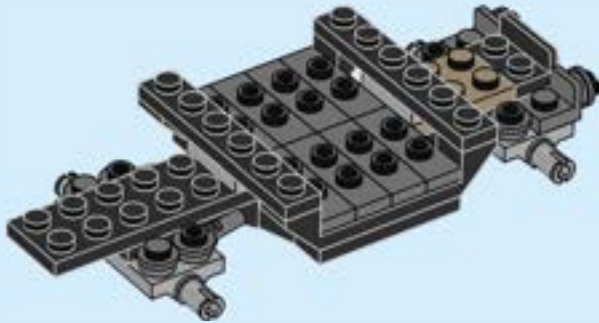

12

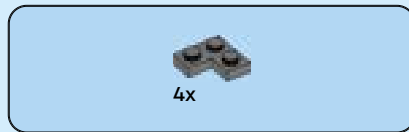
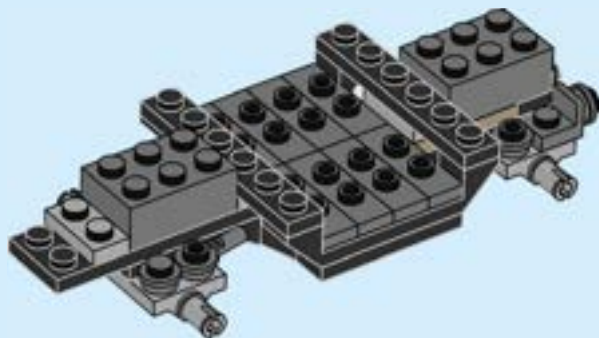

13

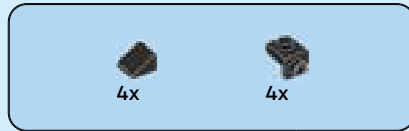
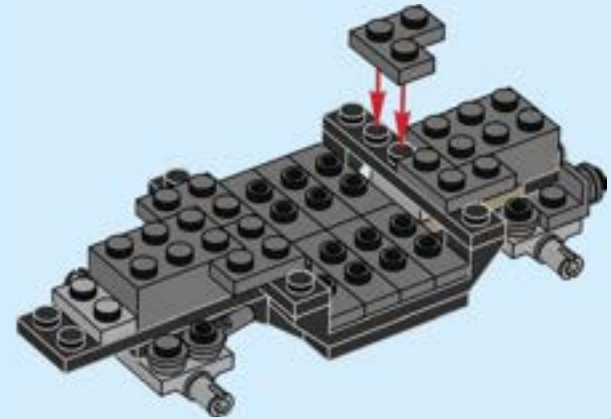

14

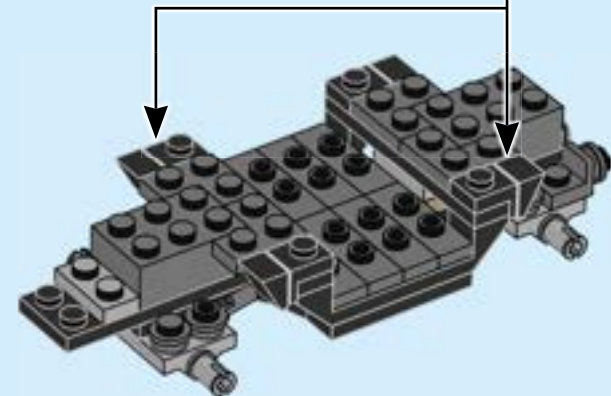
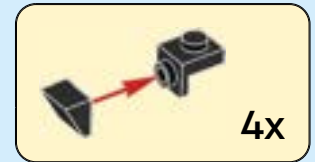



15

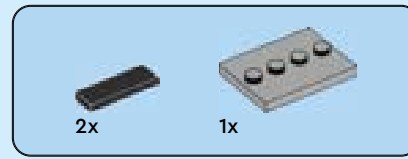
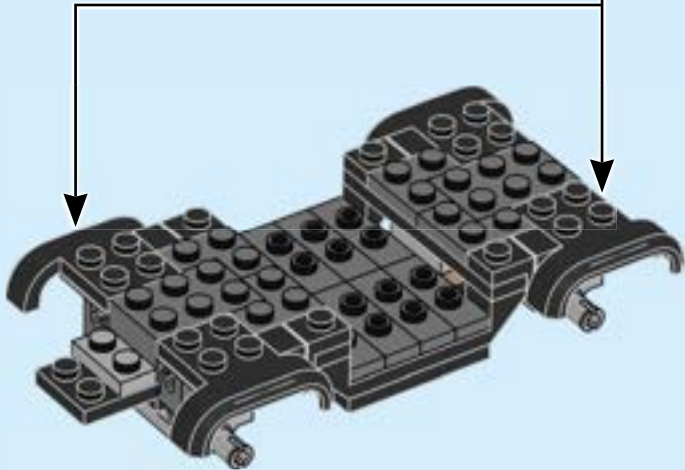
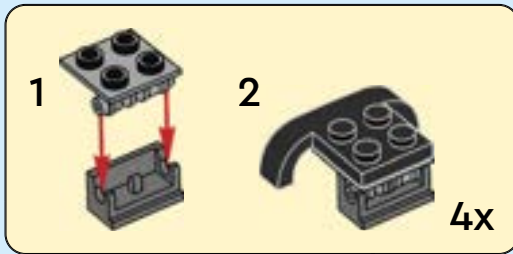

16

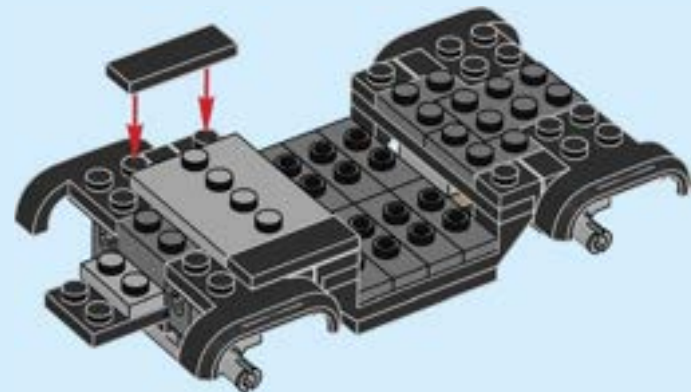

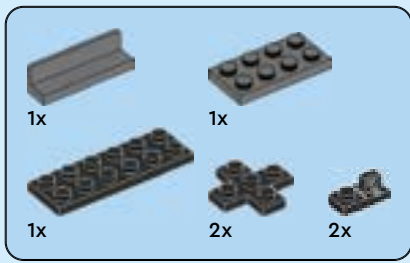

17

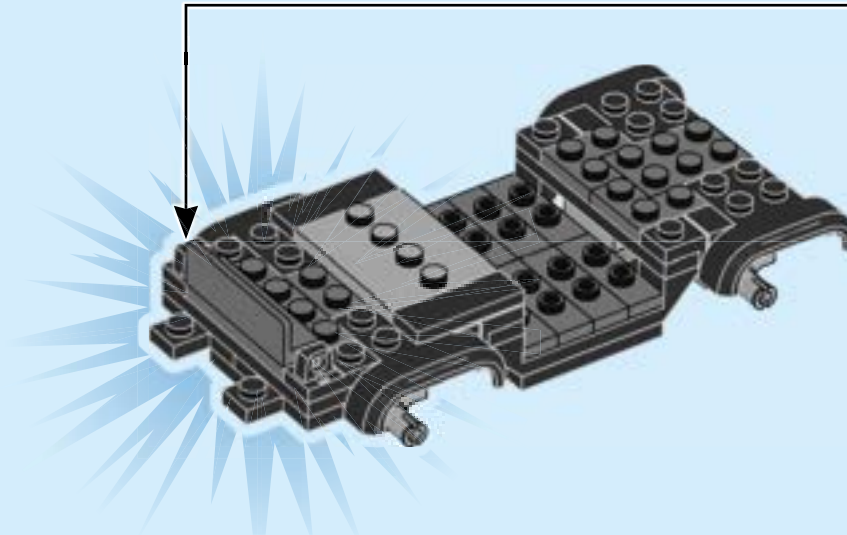
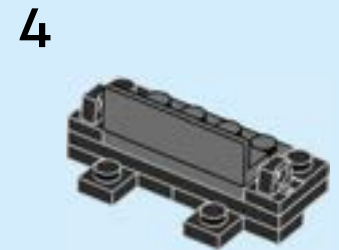
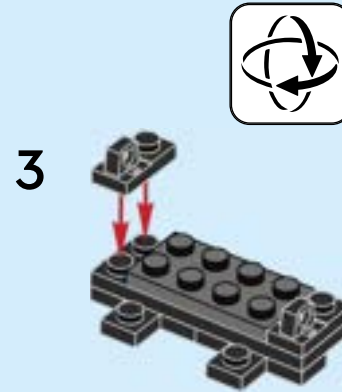
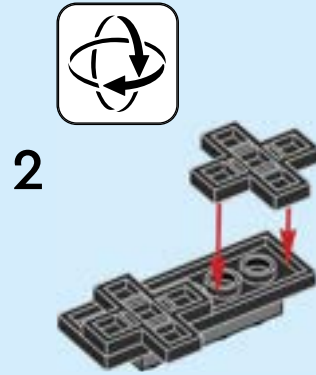

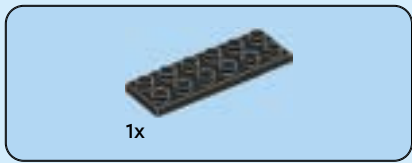

18

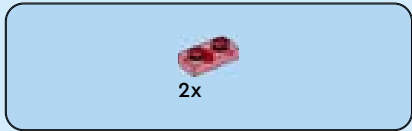
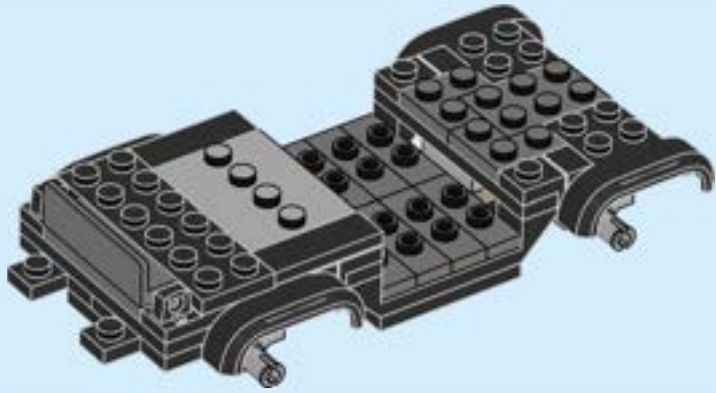

19

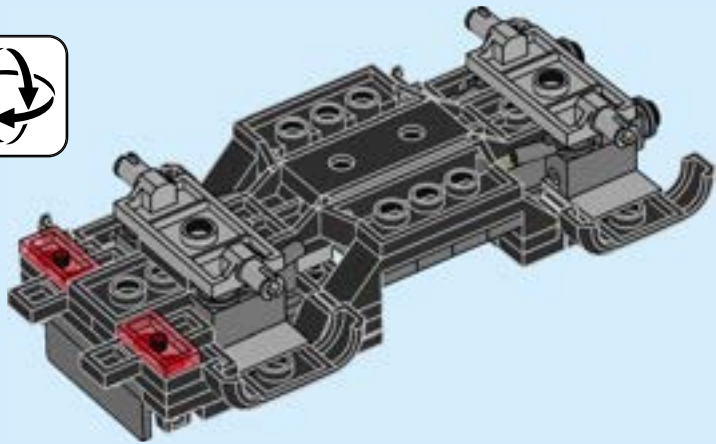

20

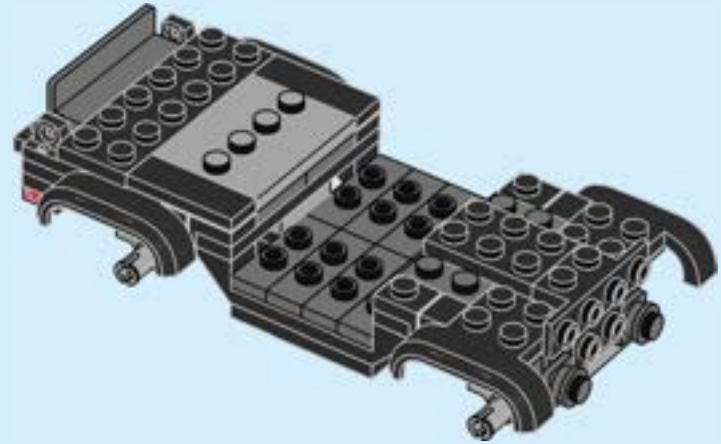

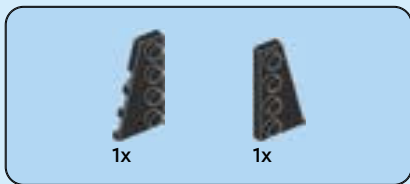

21

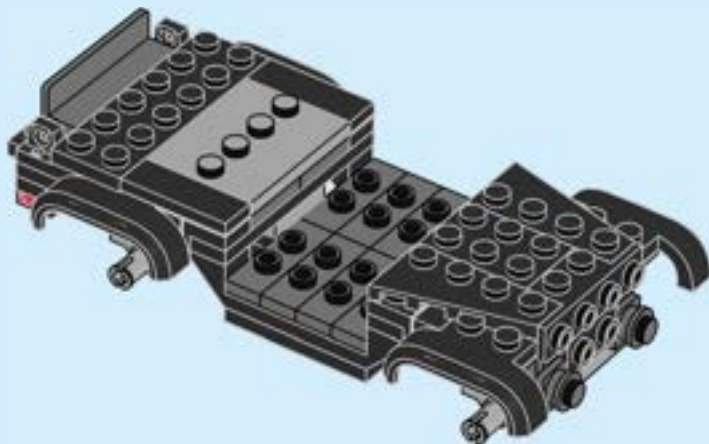

22

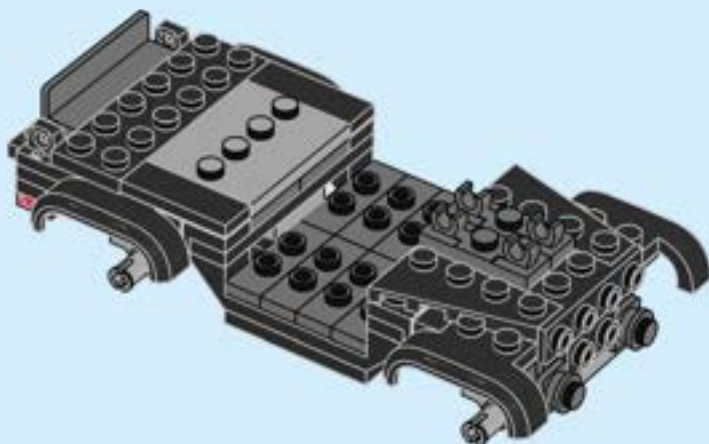

23

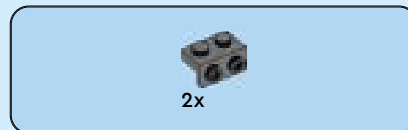
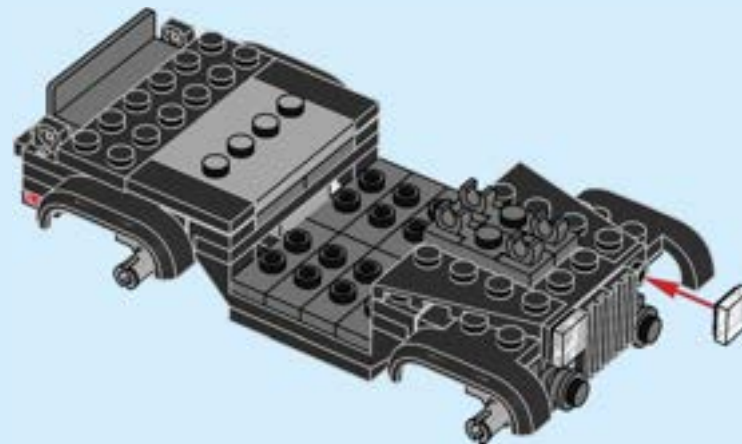

24

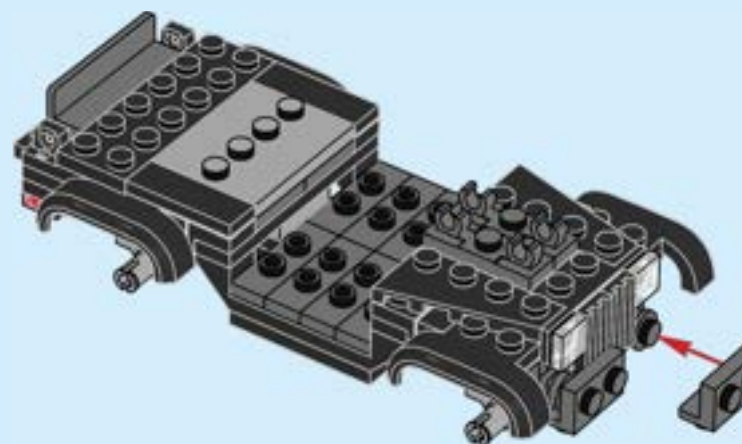

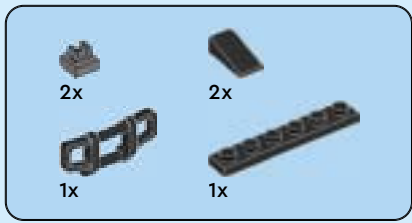

25

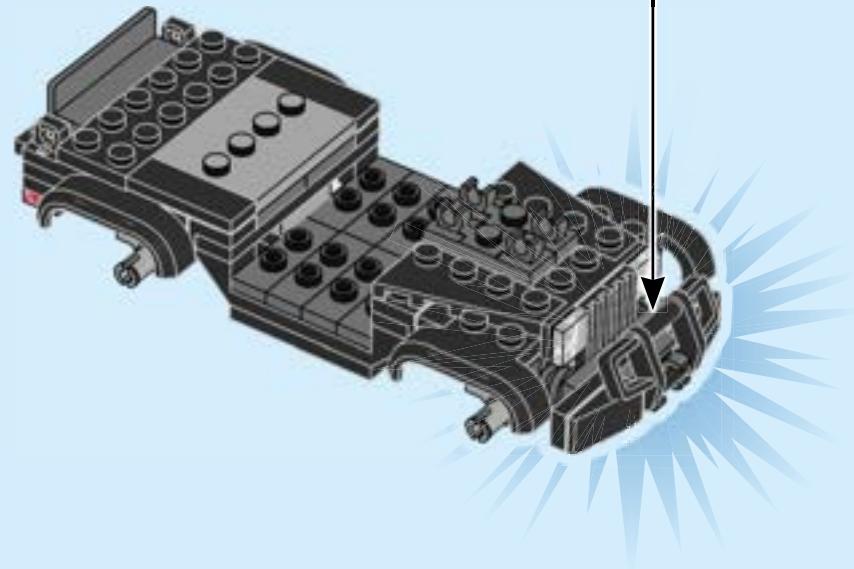
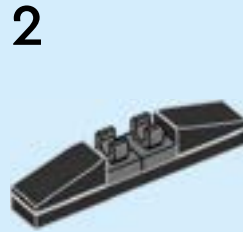
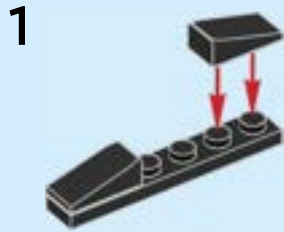

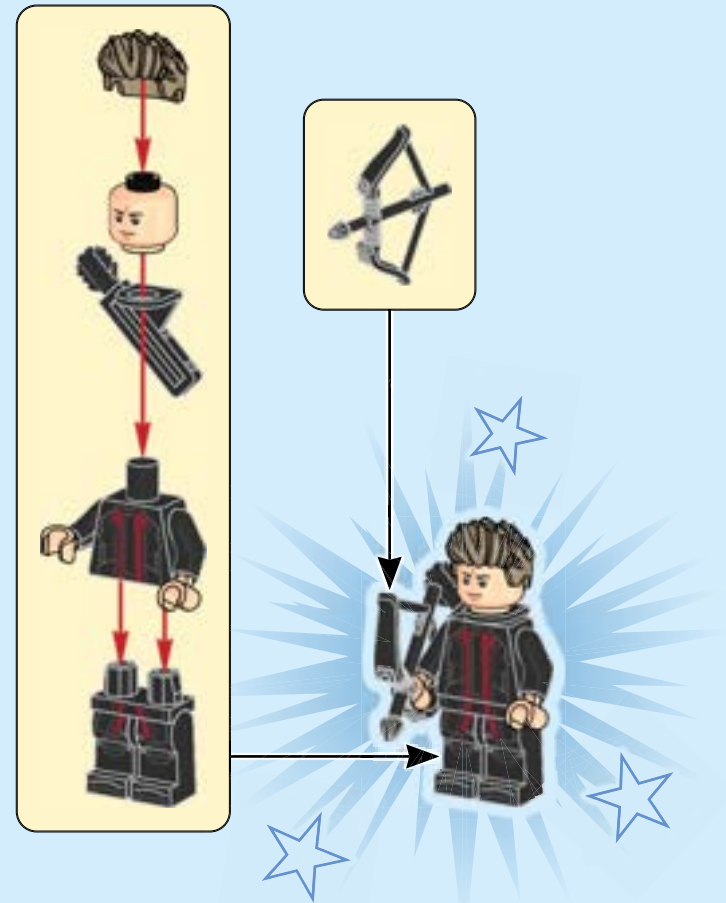

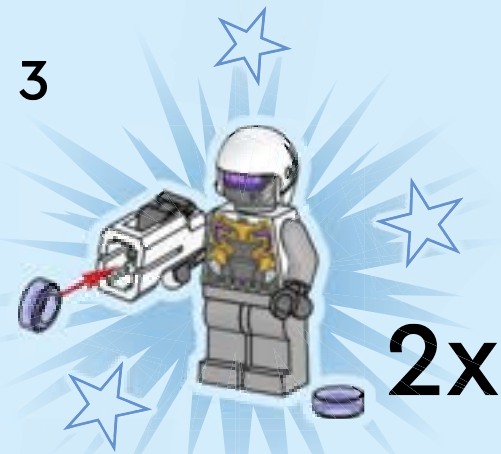
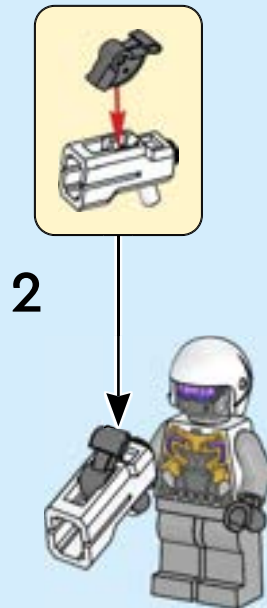
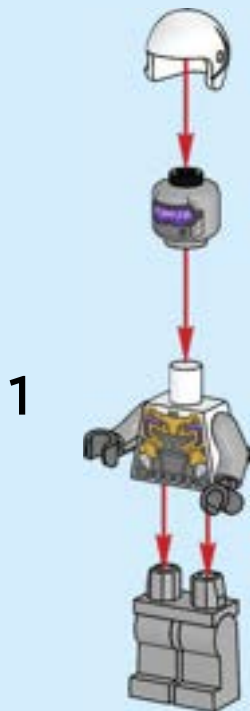
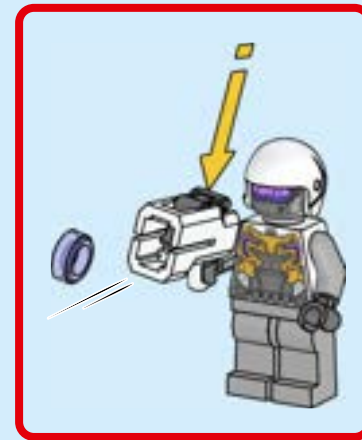
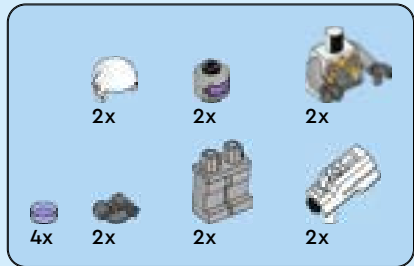



26

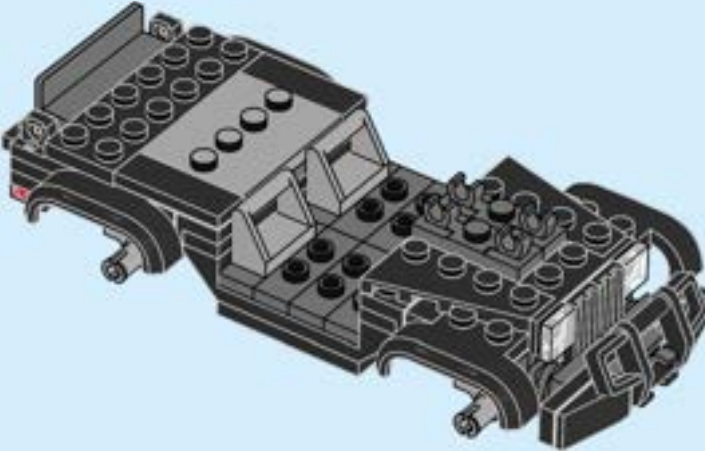

27

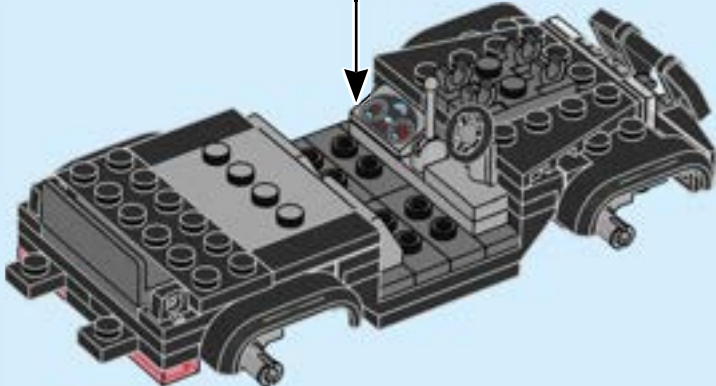
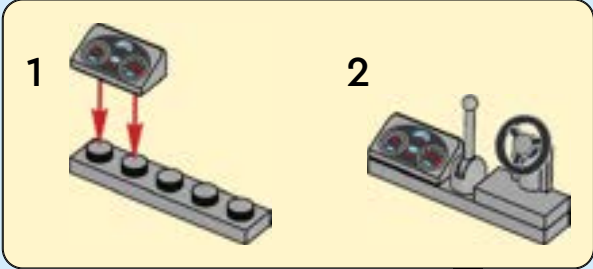

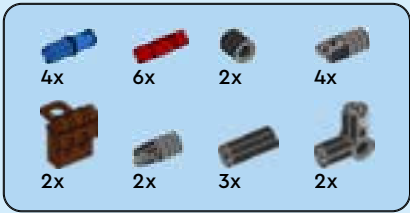

28

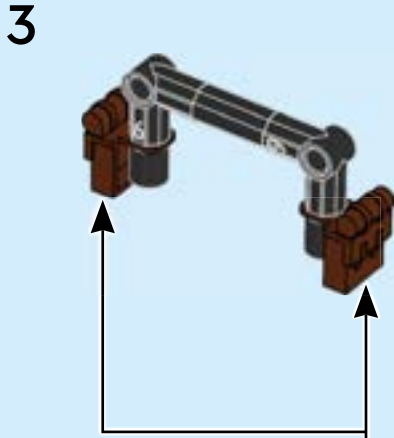

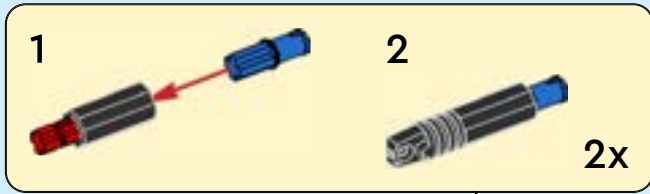

4

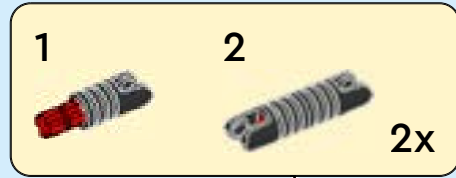
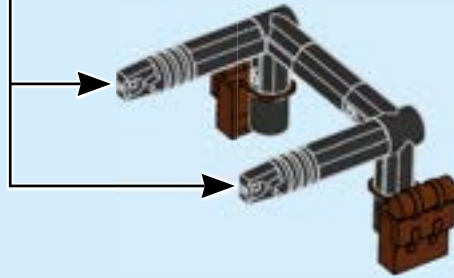

5

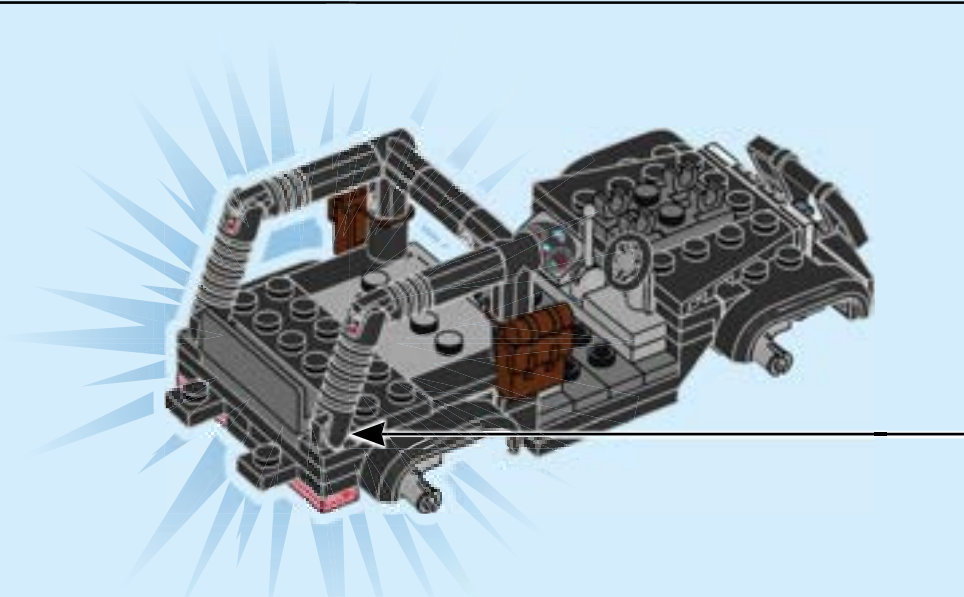
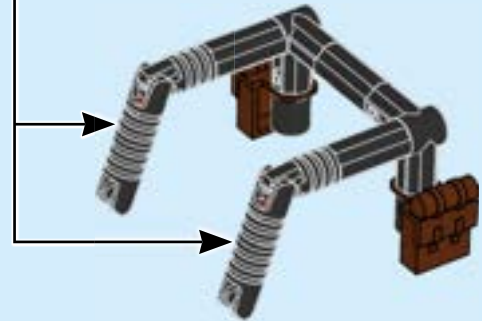

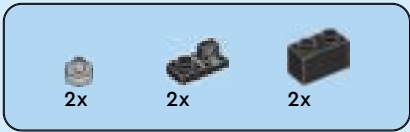

29

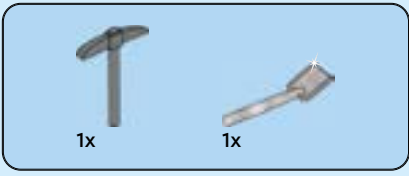
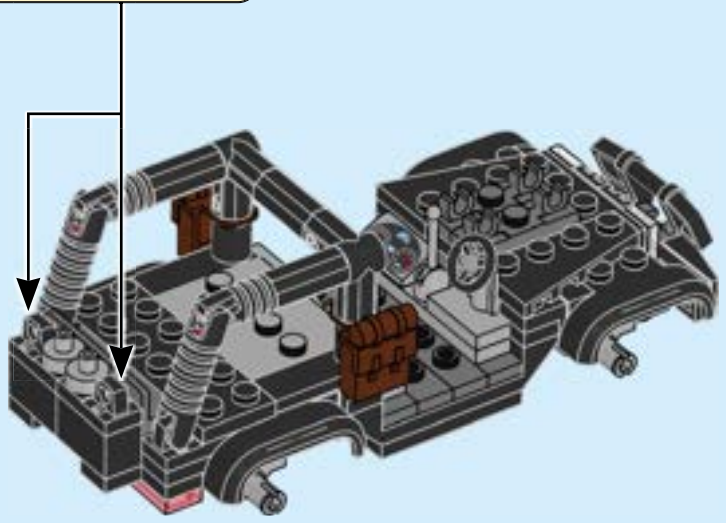
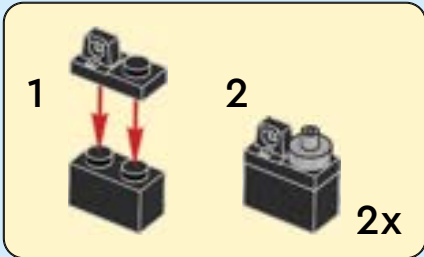

30

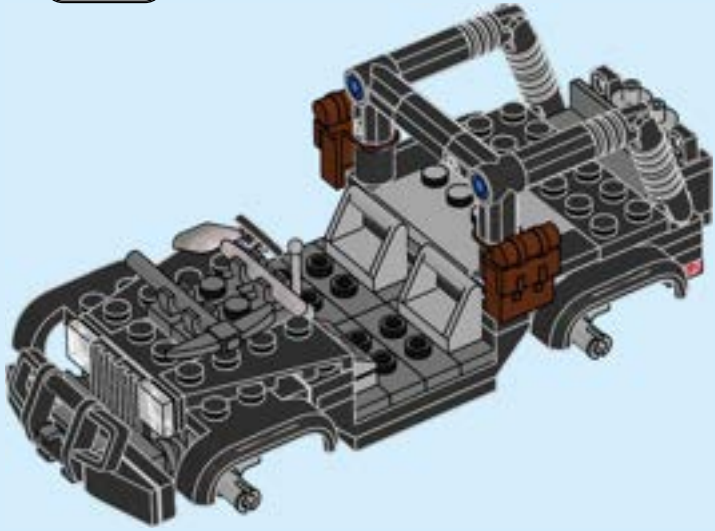

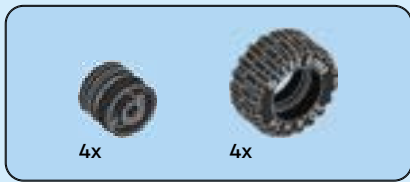

31

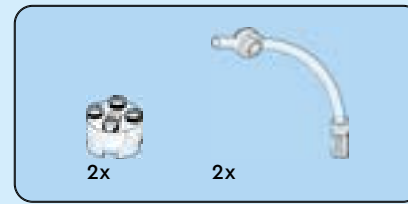
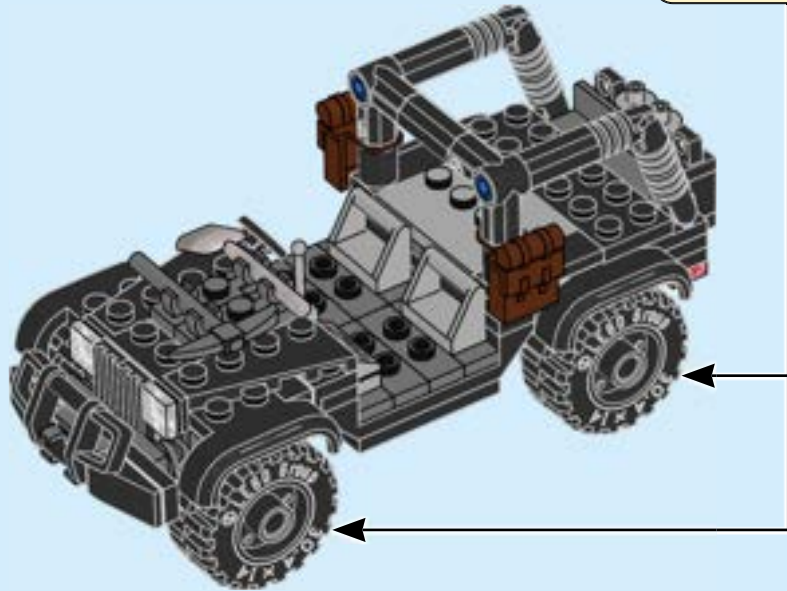
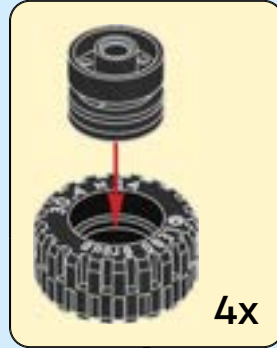

32

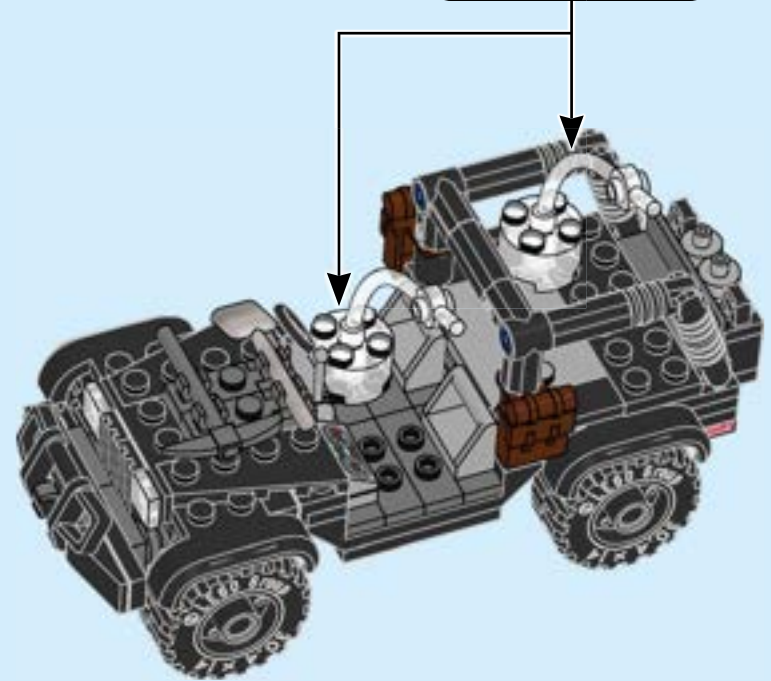
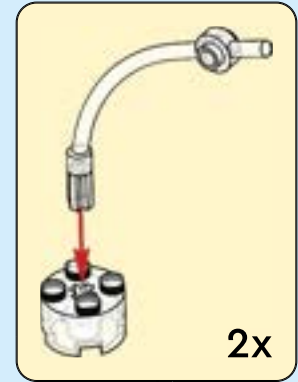

33

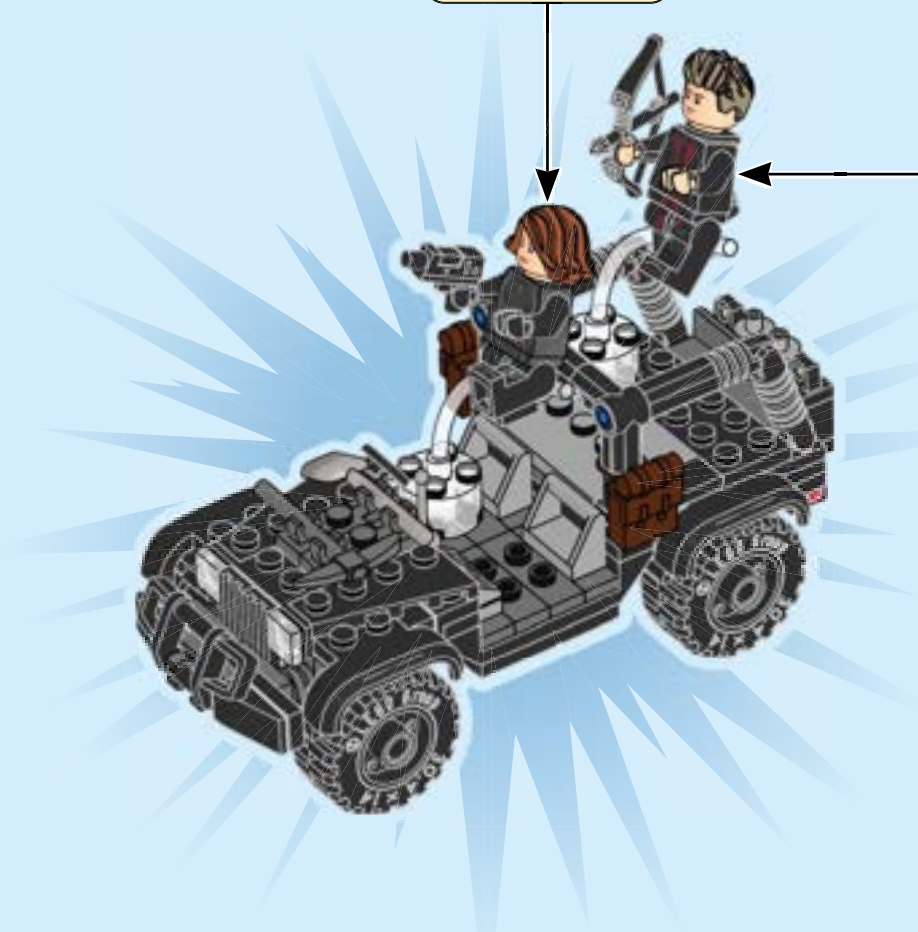
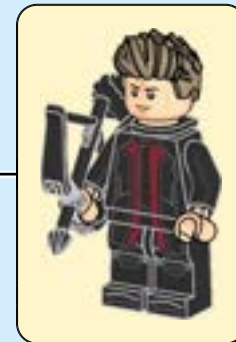

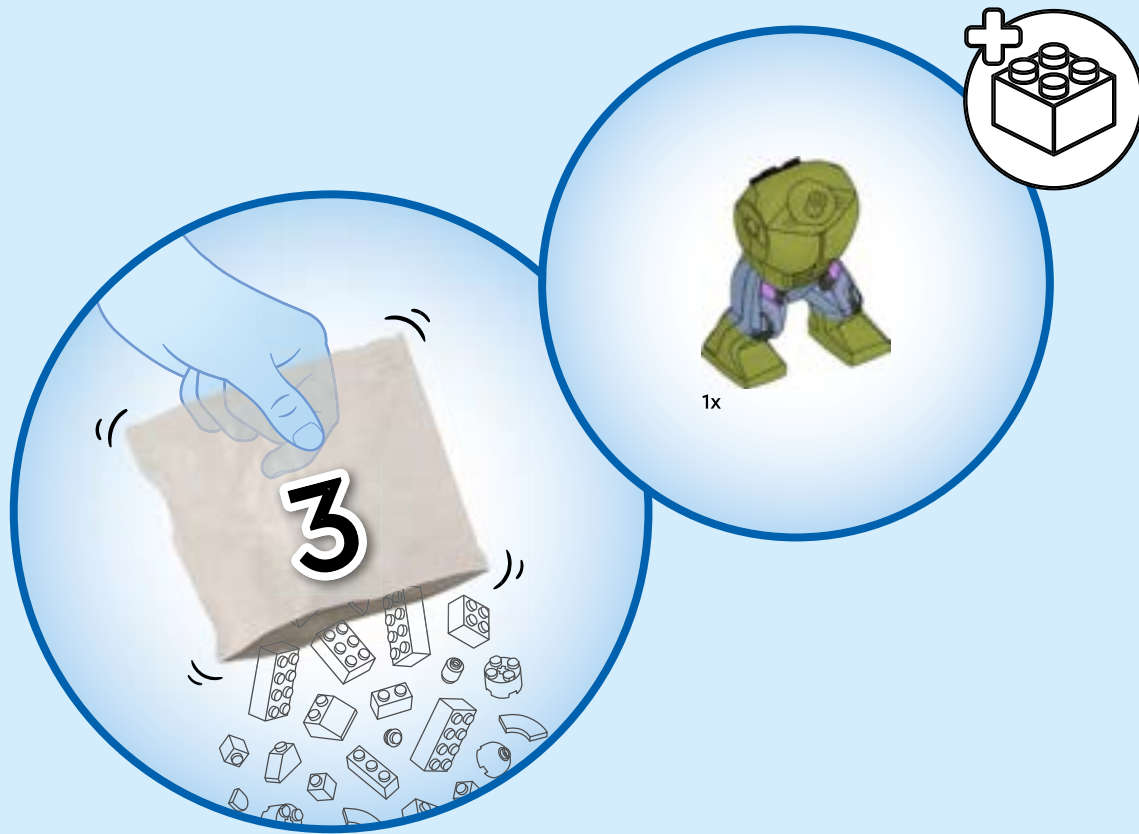

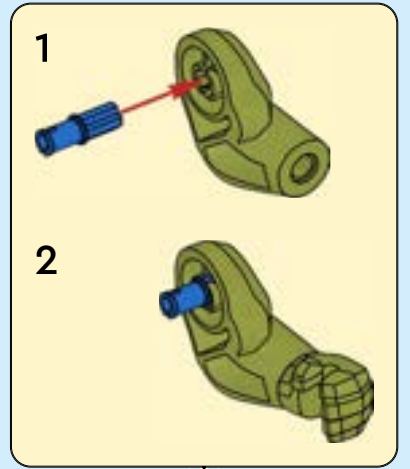
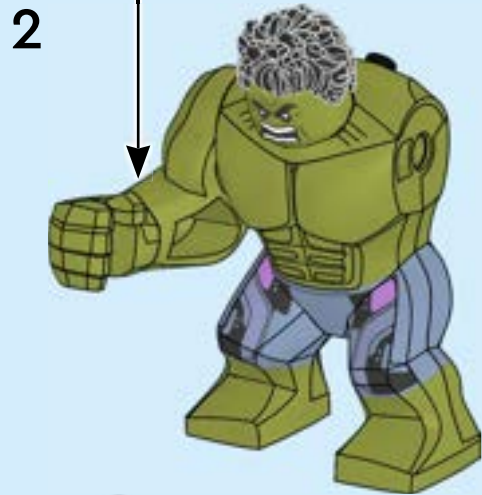
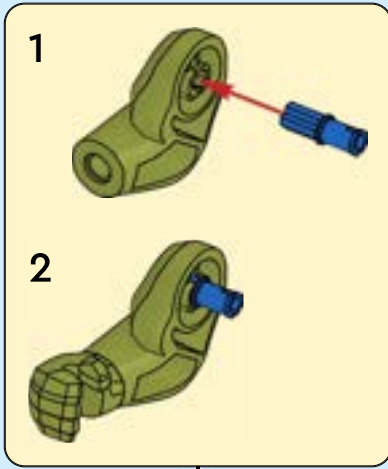
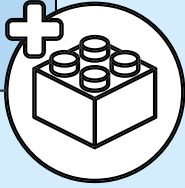
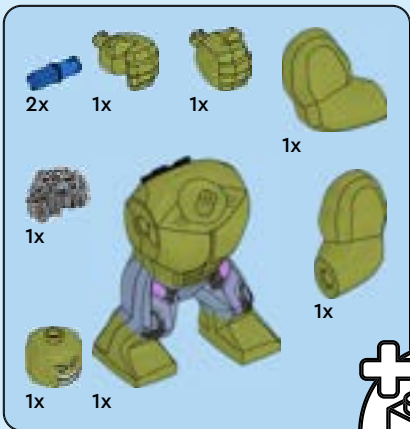

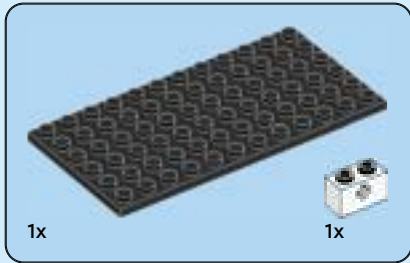

1

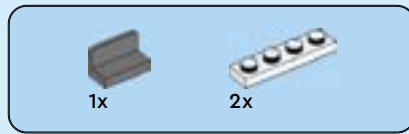
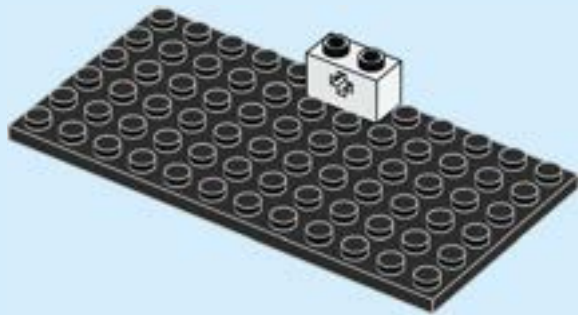

2

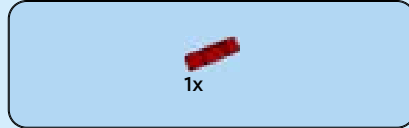
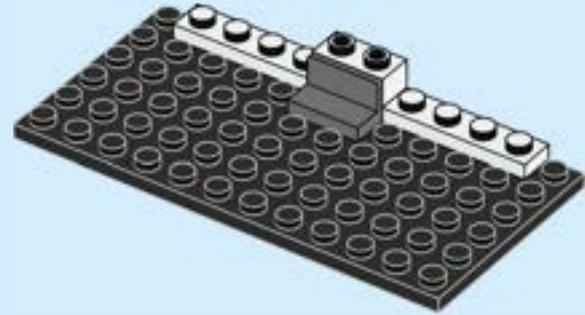

3

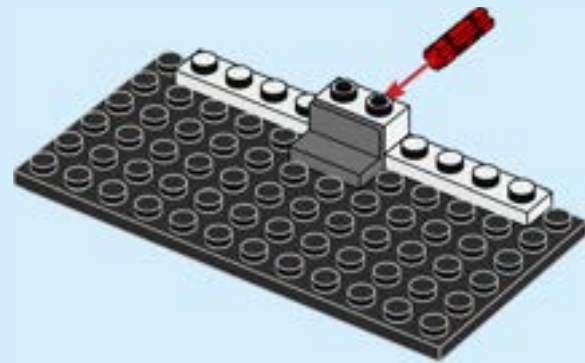



2x

4

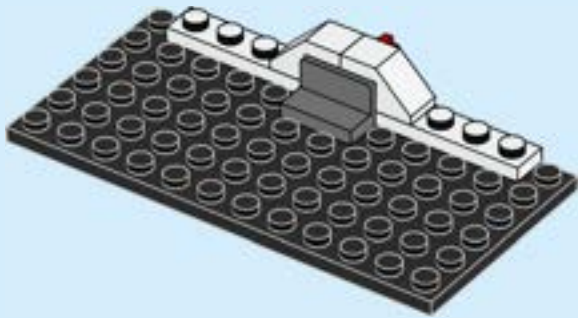

2x



2x

5



2x

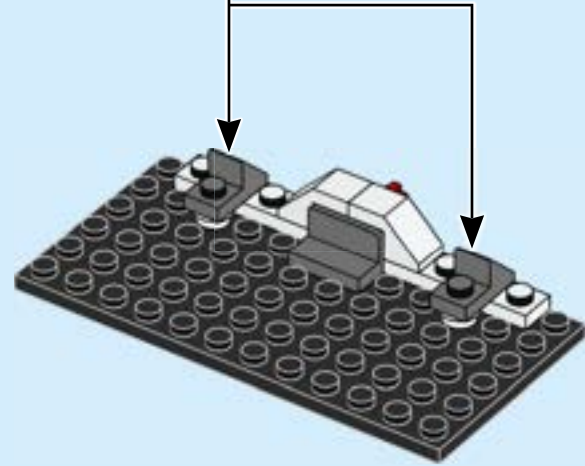

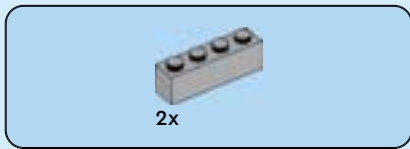

6

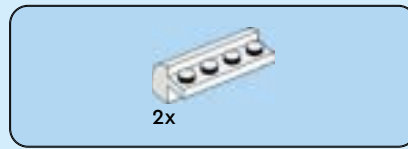
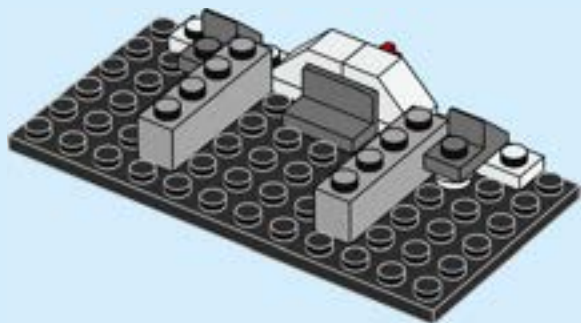

7

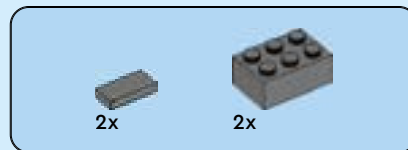
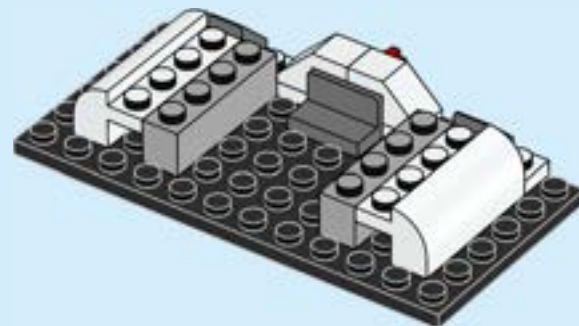

8

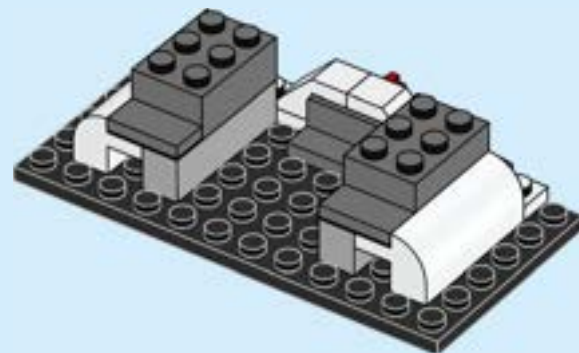

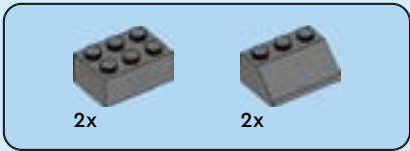

9

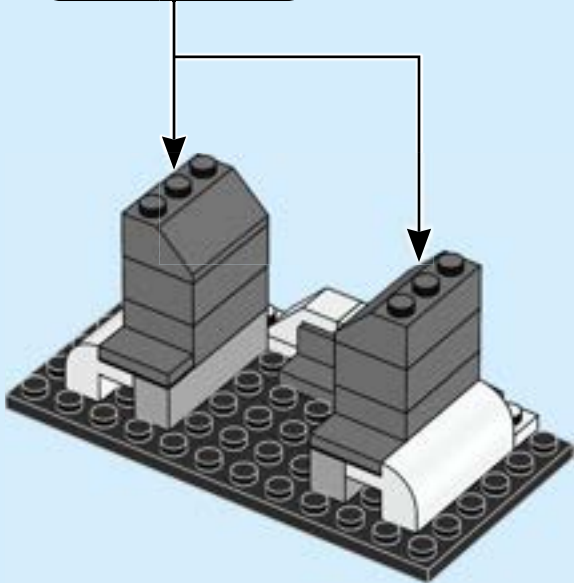
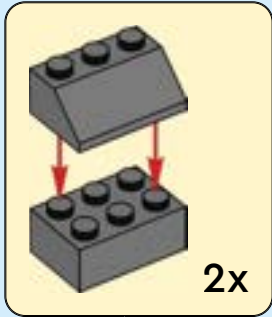

10

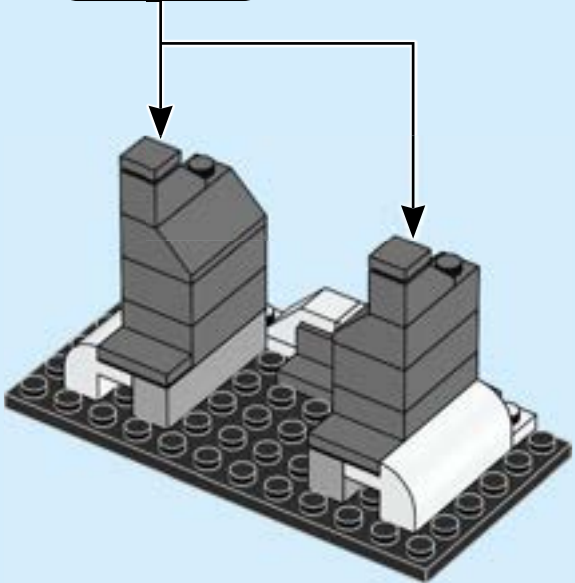
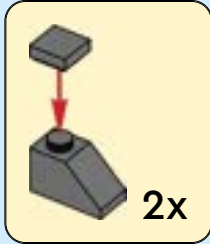

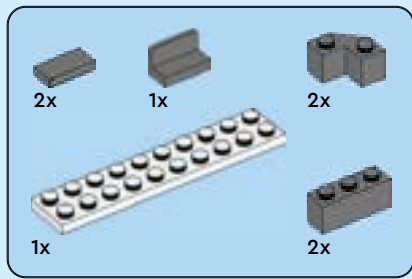

11

1

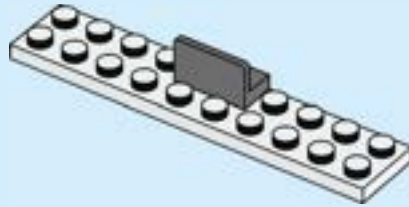

2

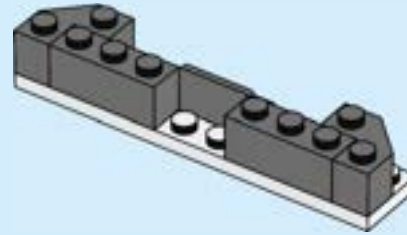

3

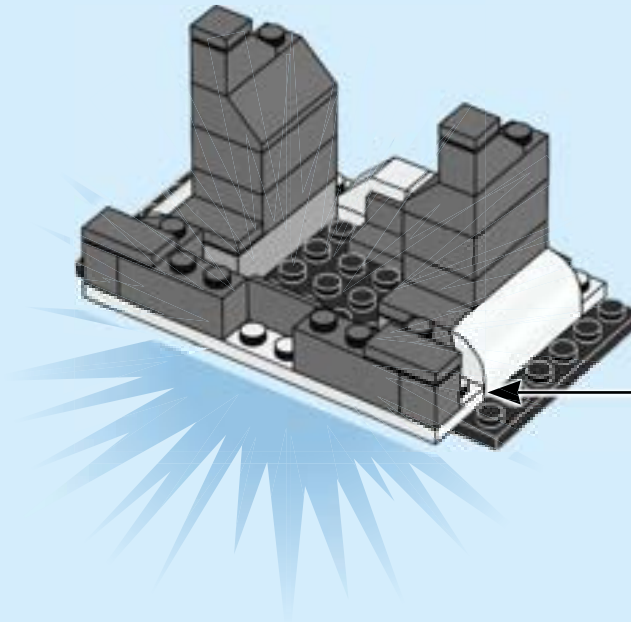
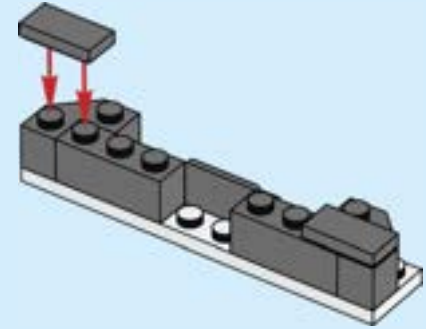



12

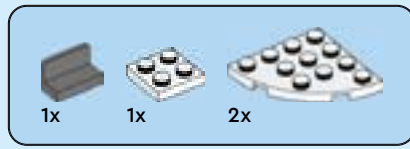
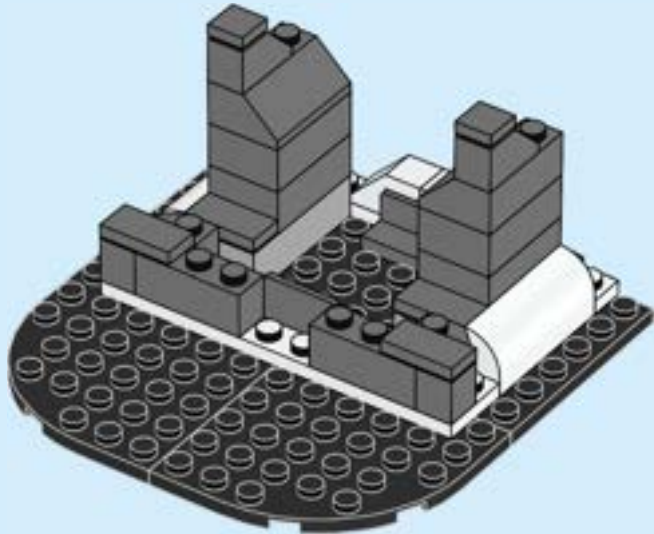

13

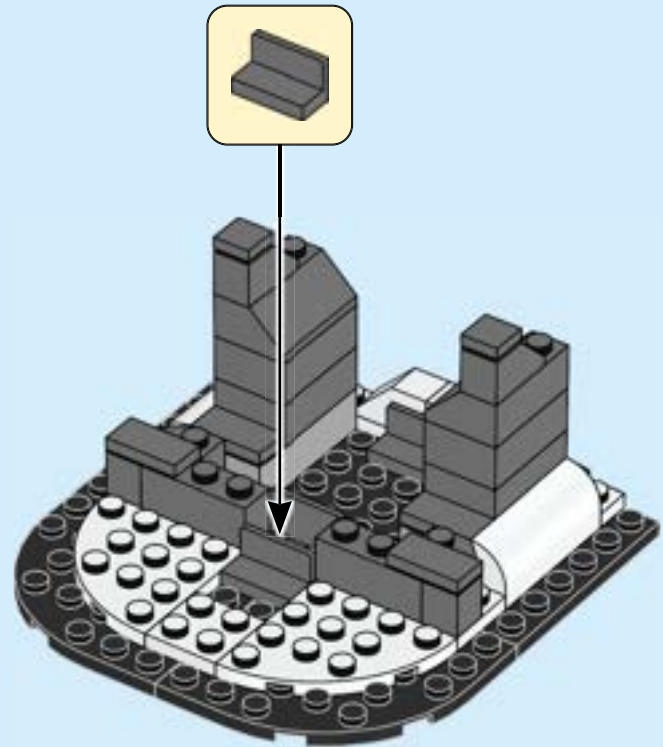

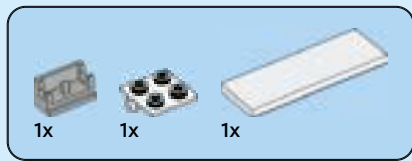

14

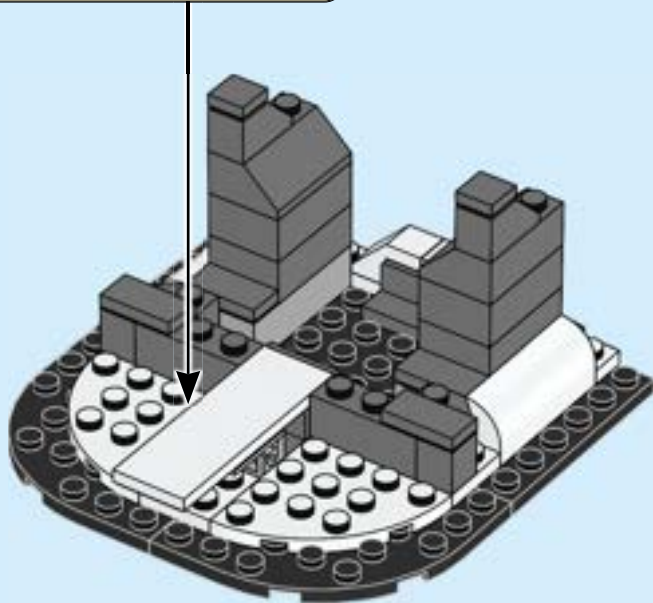
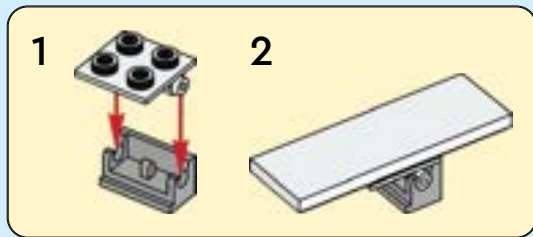

15

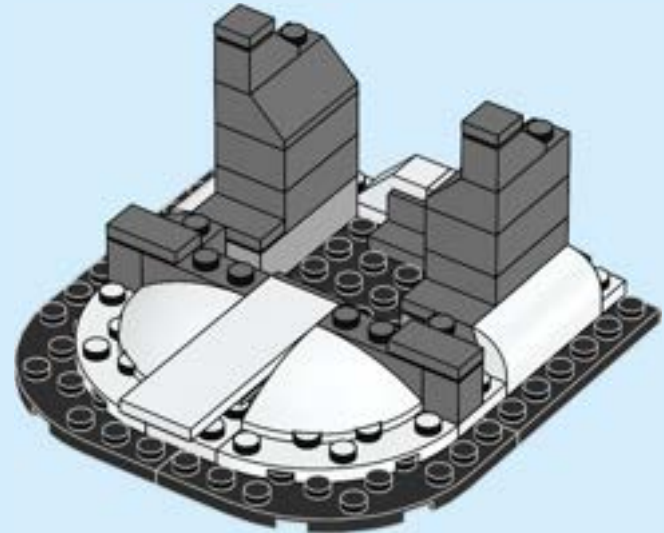



16

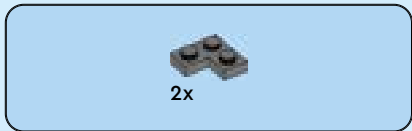

17

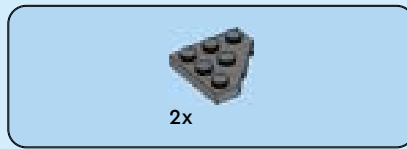
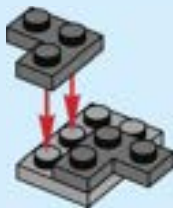

2x

18

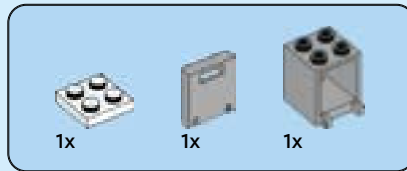

19

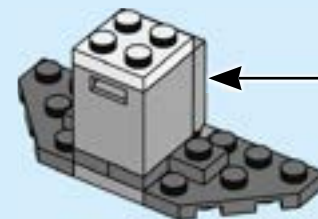
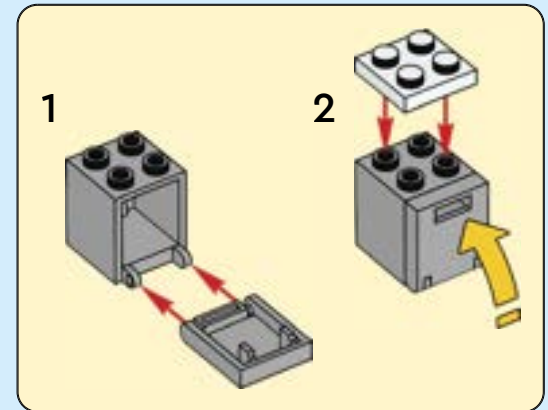

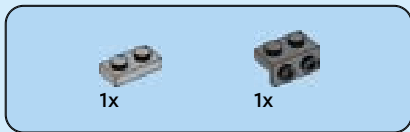

20

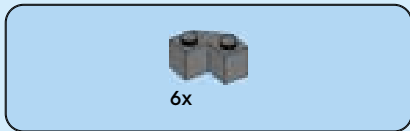
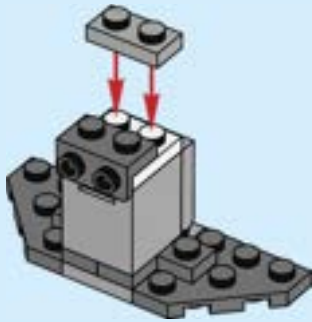

21

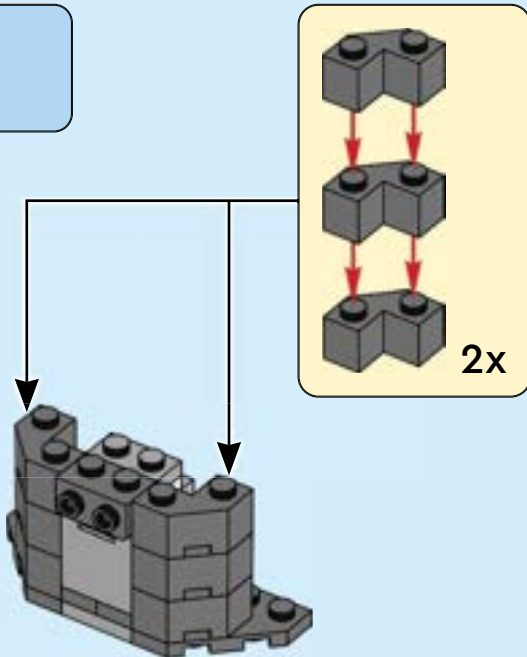

22

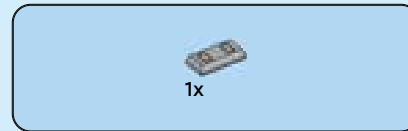

23

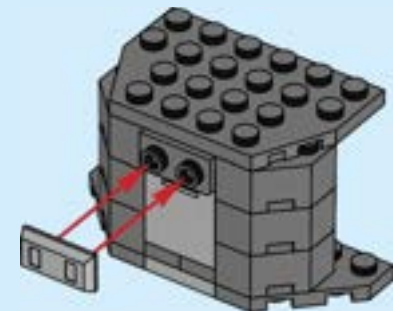



4x

24

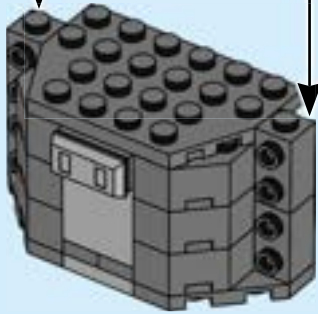

2x

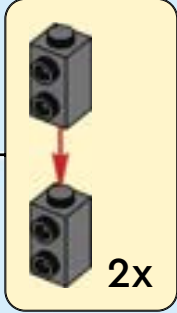

2x

25

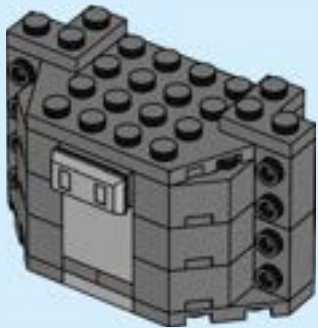

4x



4x

26

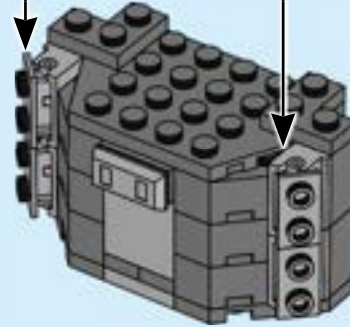

4x

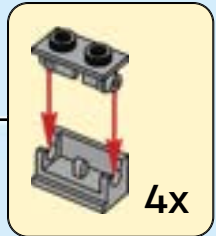

2x

27

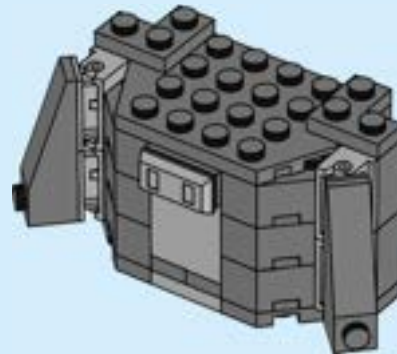

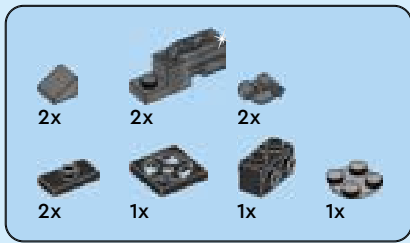

28

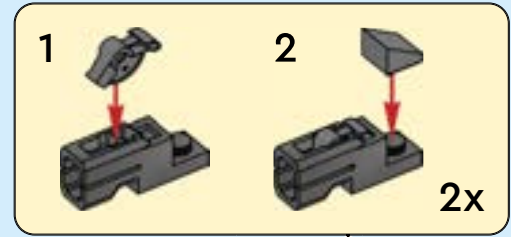

1



2



3



4

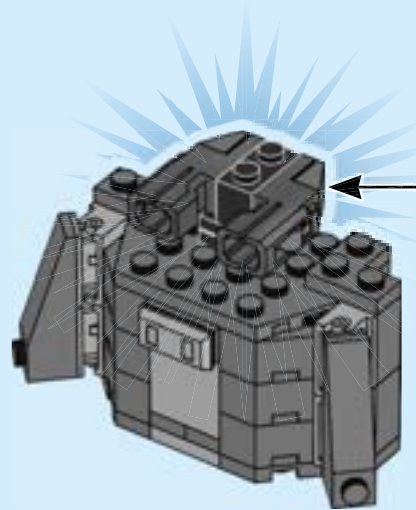
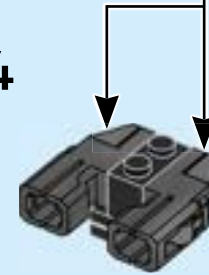

29

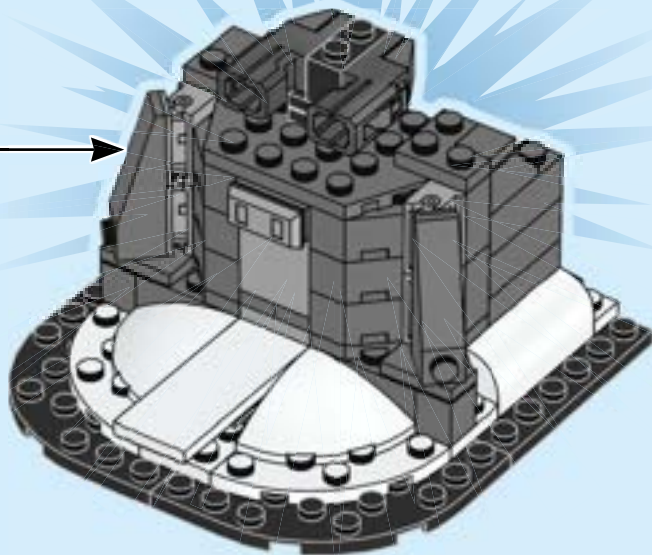

2x 1x

A rectangular box containing two small images of LEGO parts. The first image shows a white Technic pin with the number '2x' below it. The second image shows a white Technic pin with a black axle through the center, with the number '1x' below it.

30

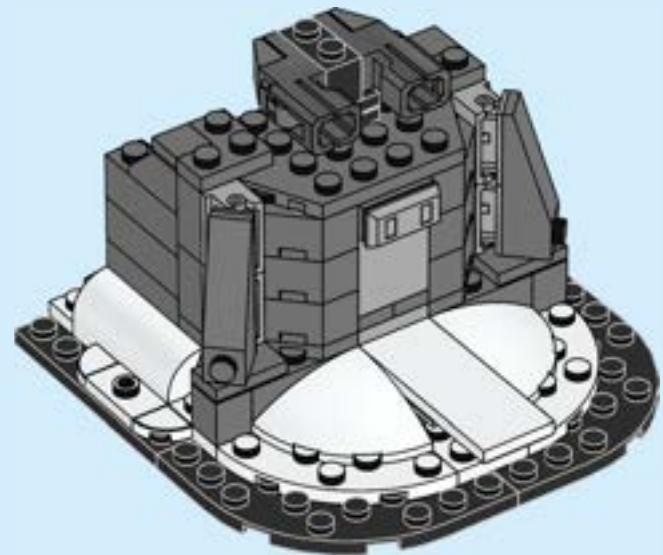

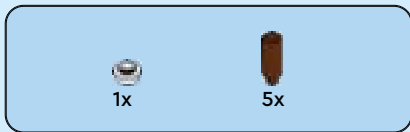

31

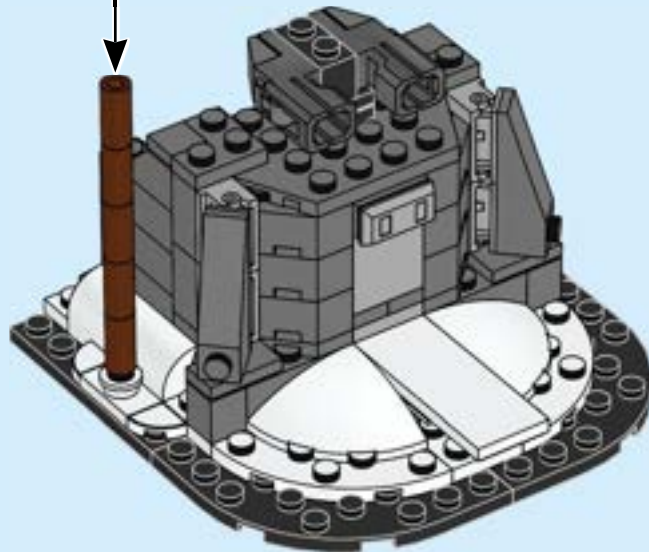
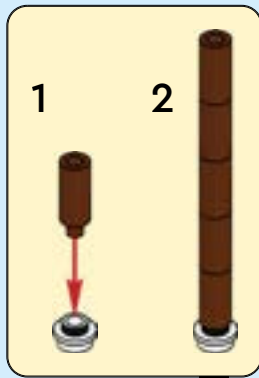



32

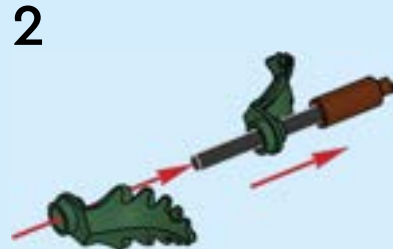
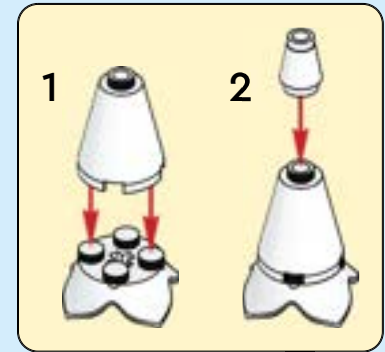

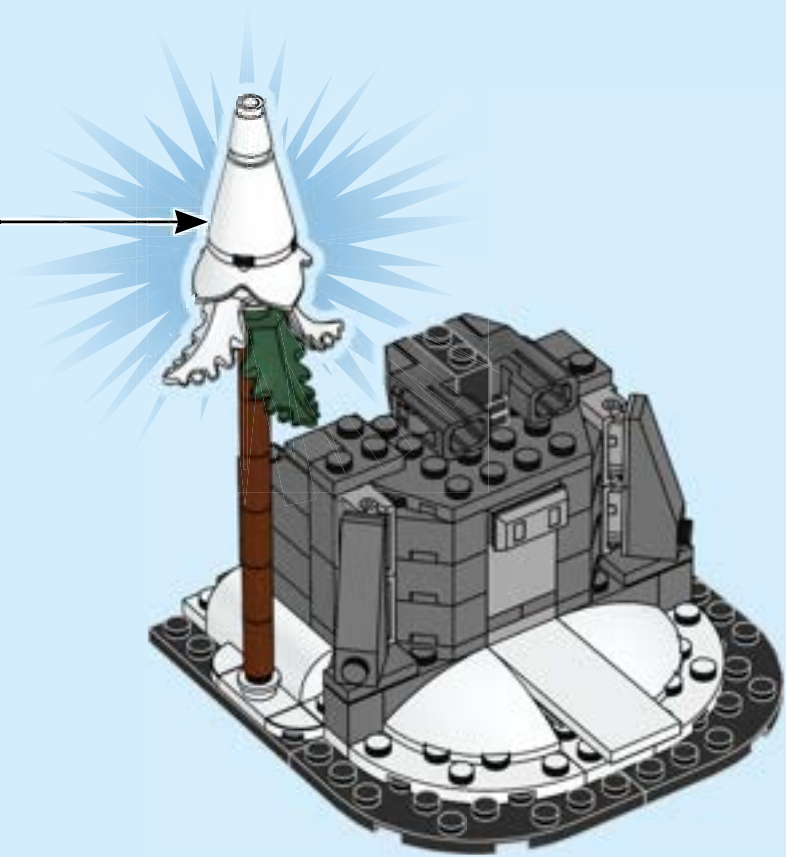

1

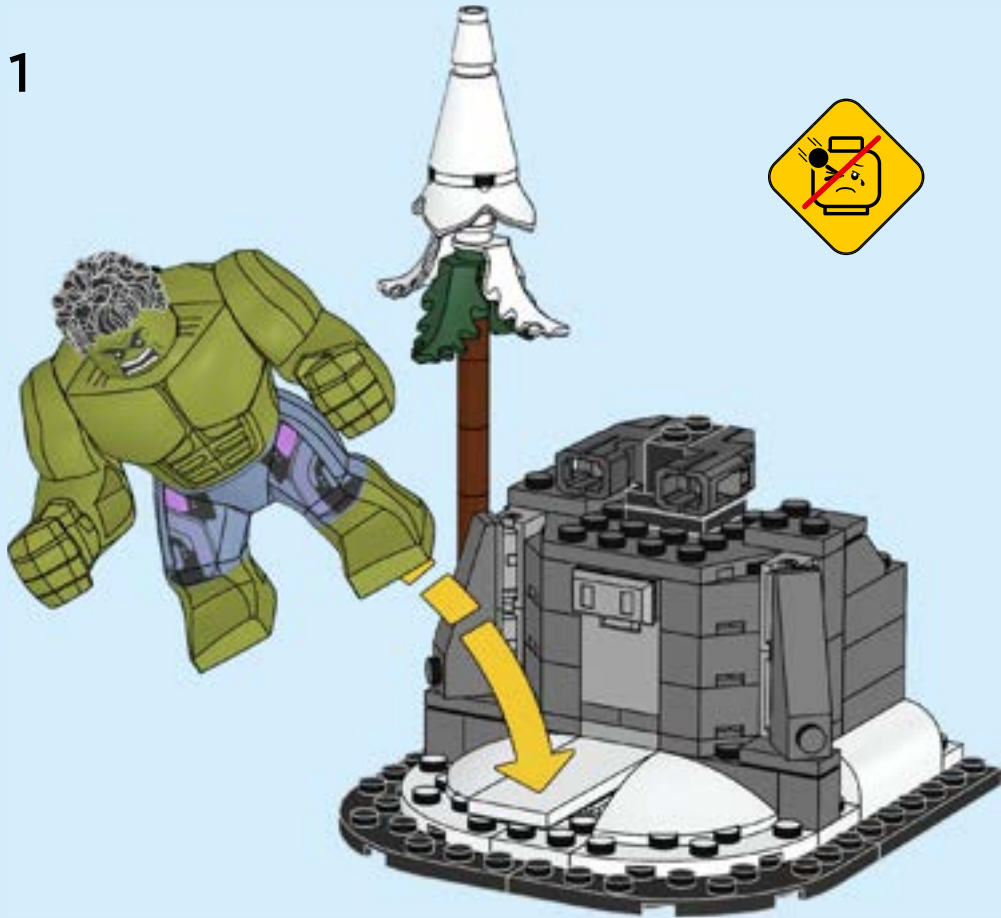

2

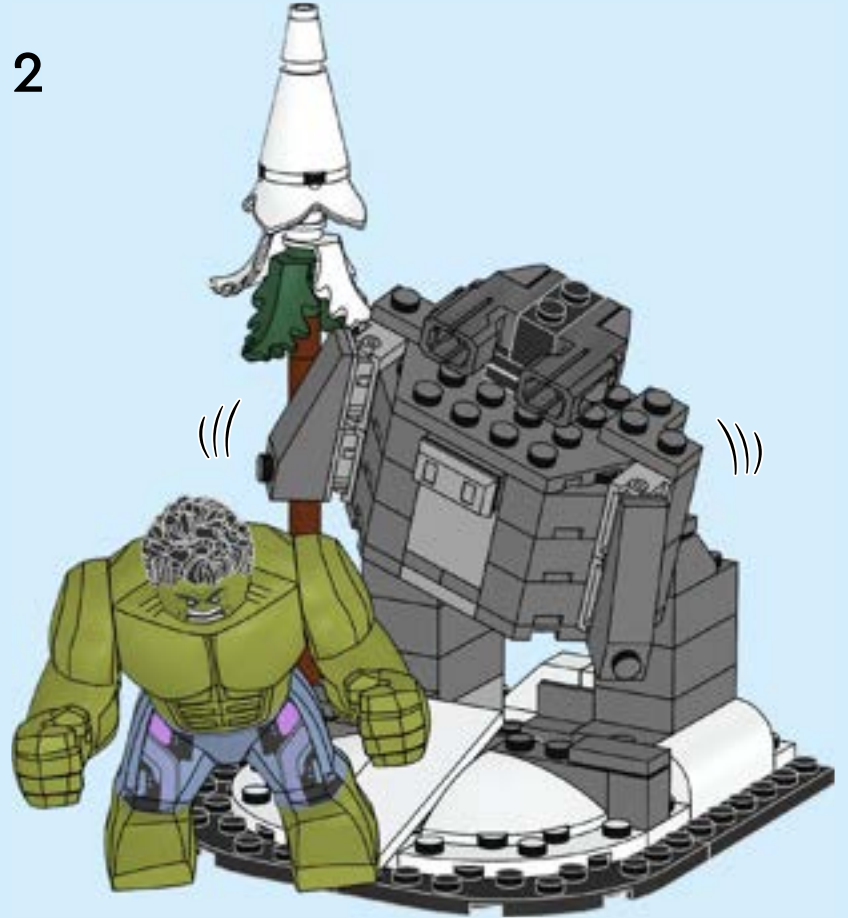

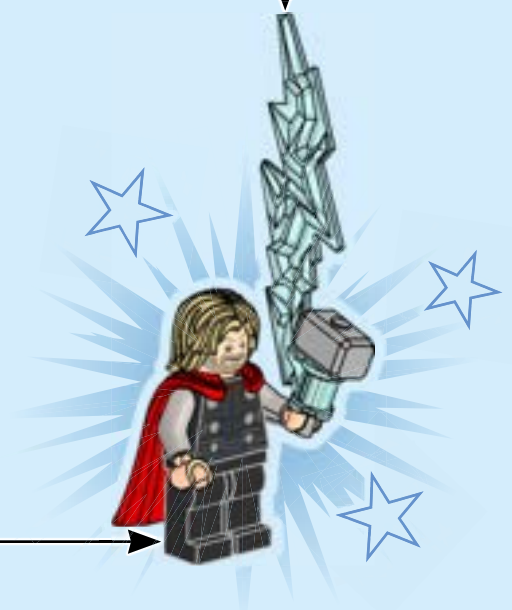

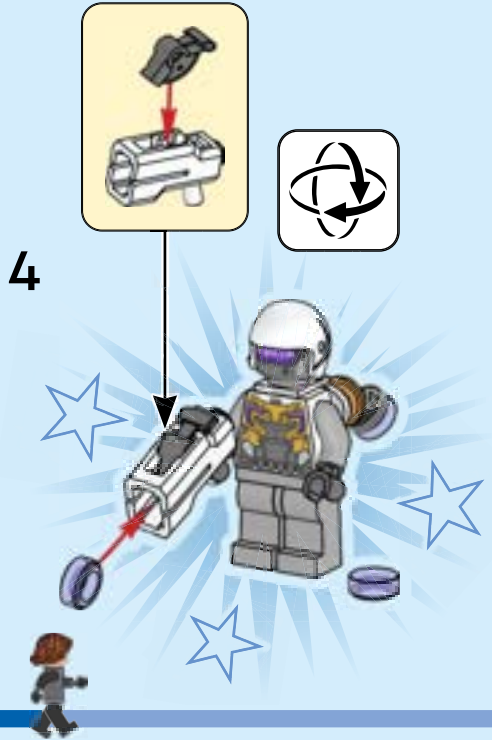
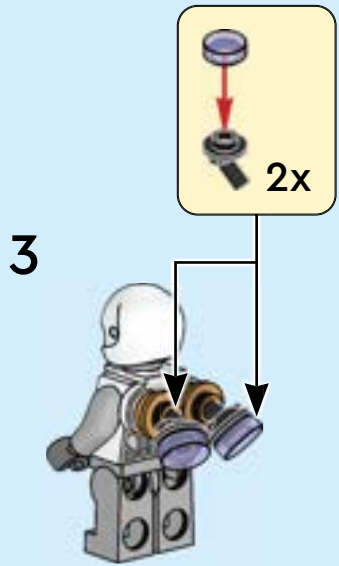
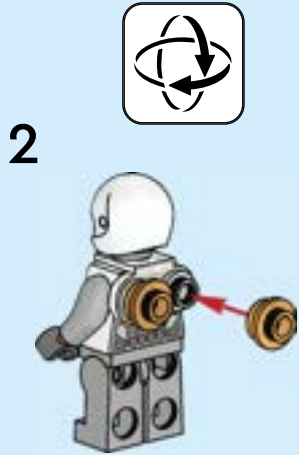
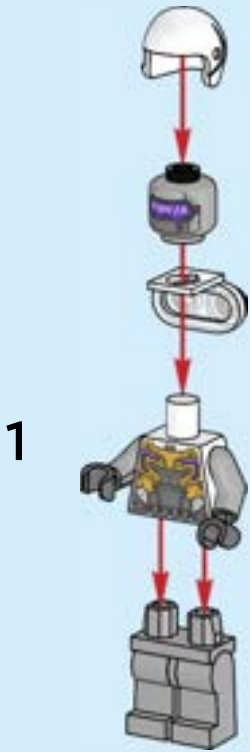
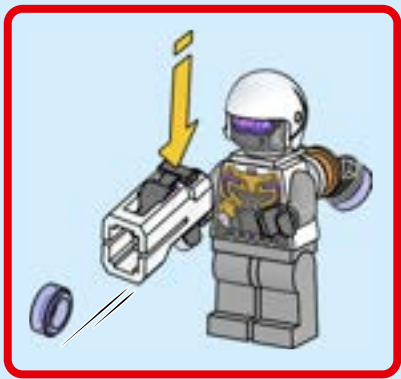
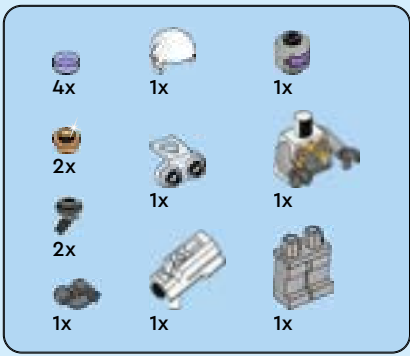

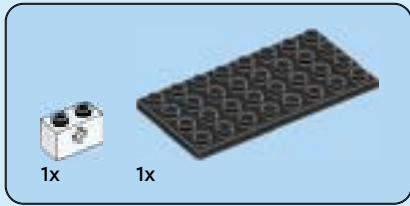
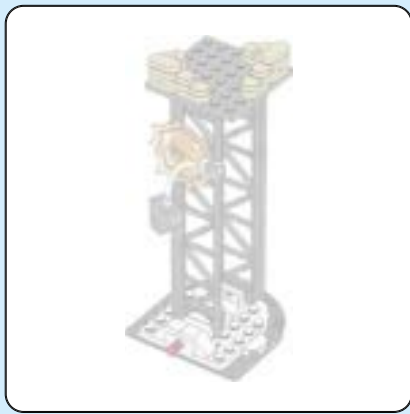

1

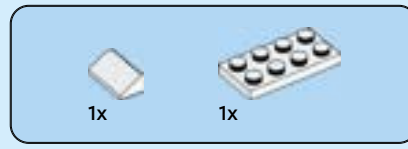

2

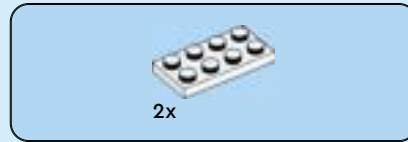
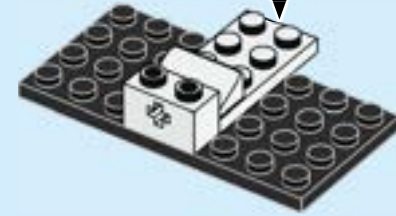
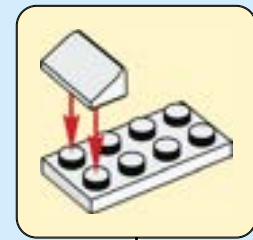

3





2x

4



1x

5





6

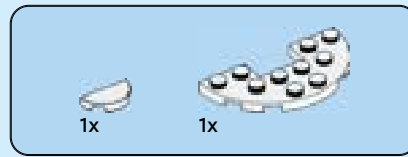
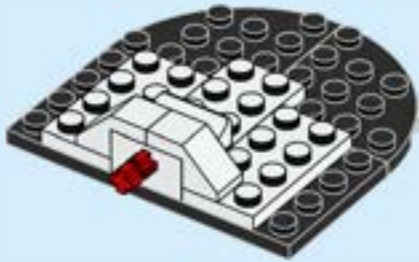

7

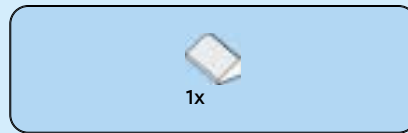

8

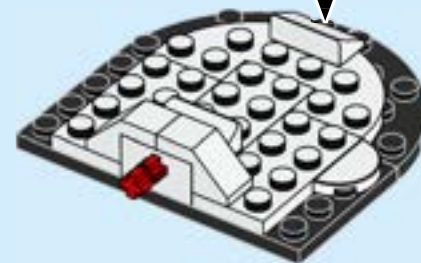

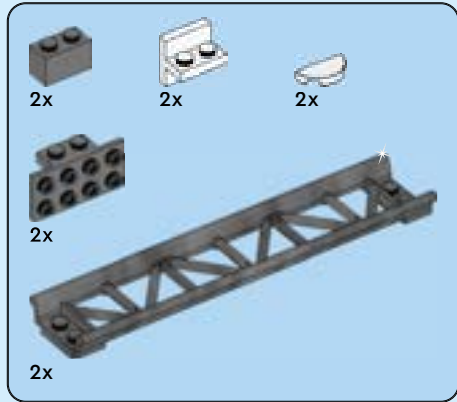
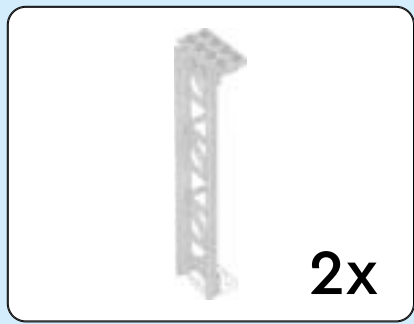

9

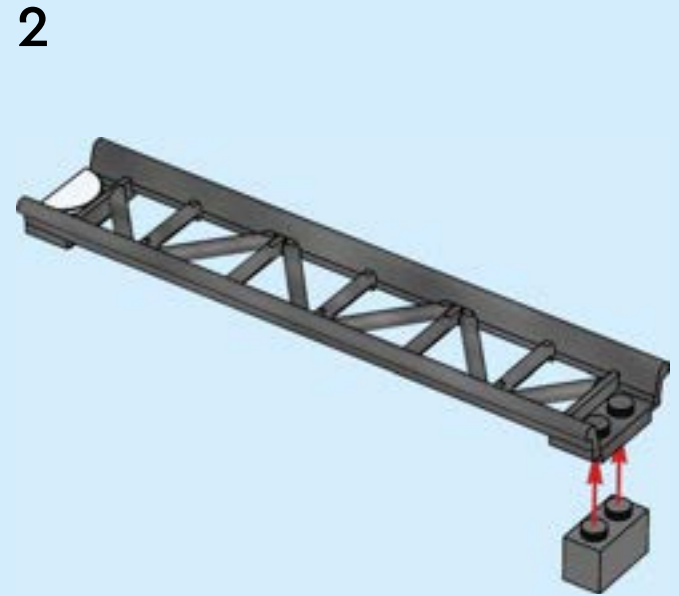

3

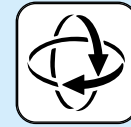

4

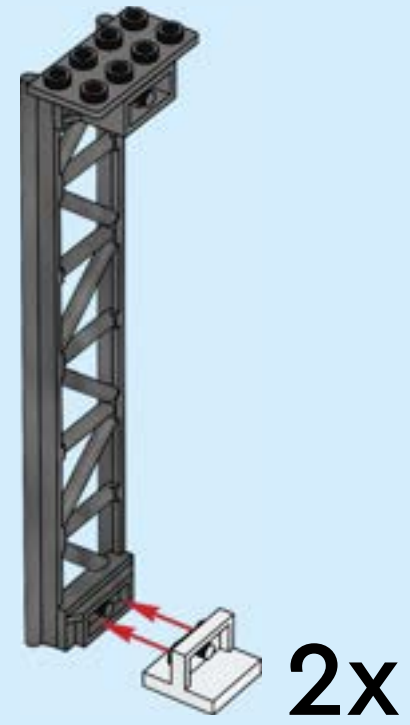

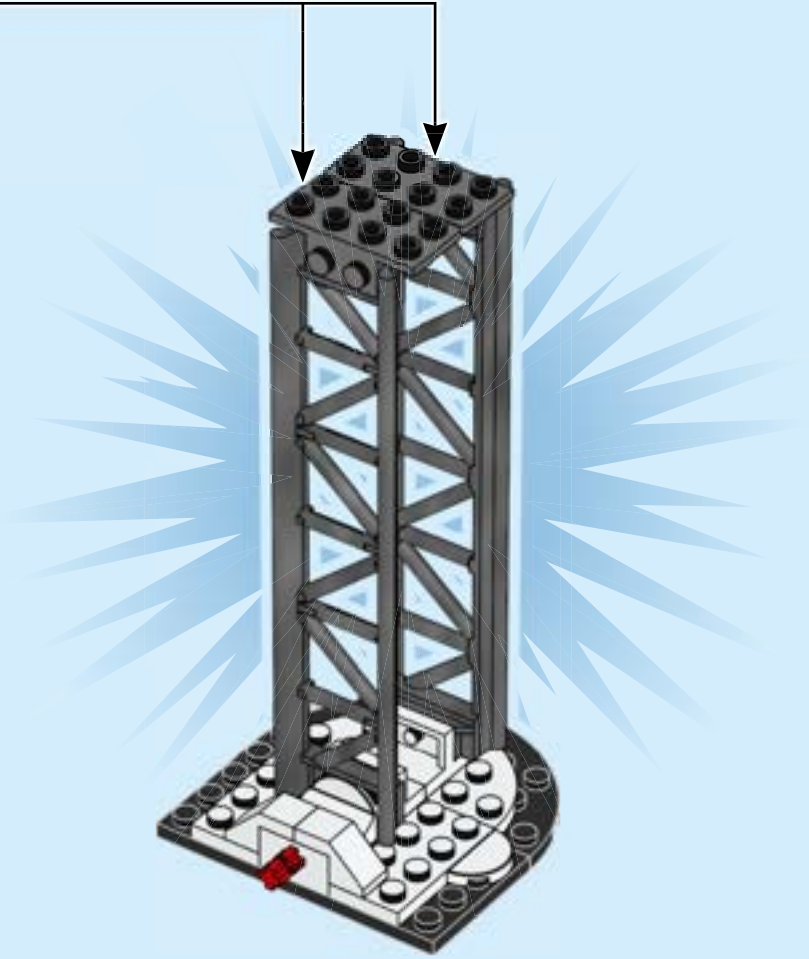

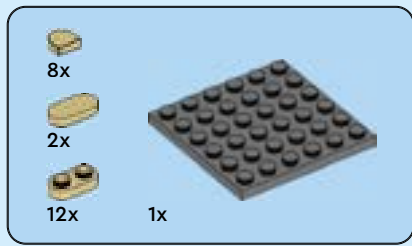

10

1



2



3



4



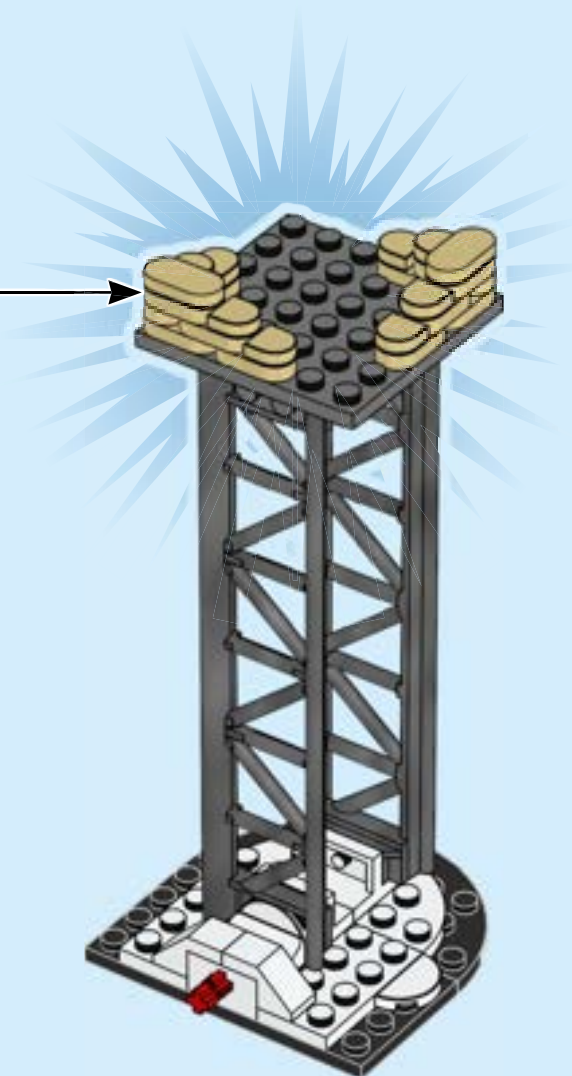

11

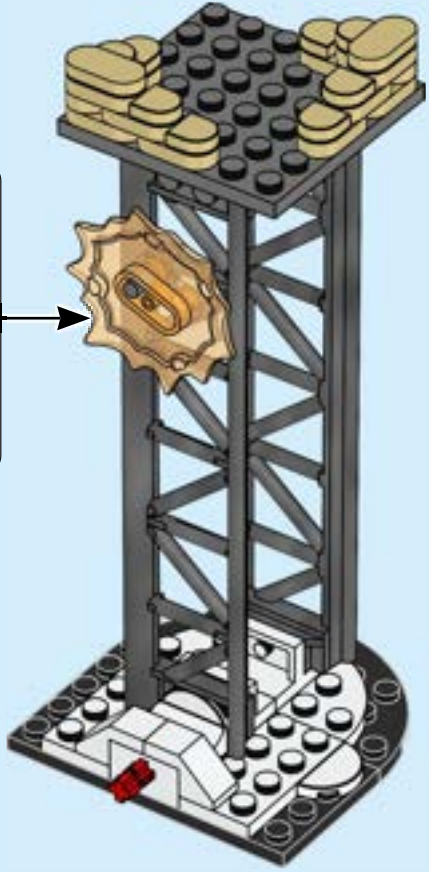

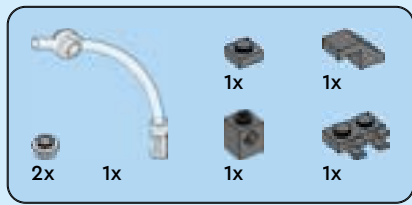

12

1



2



3



4

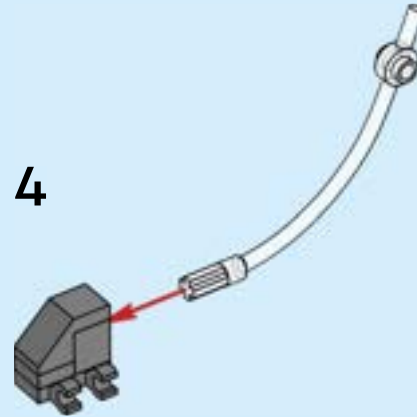

5

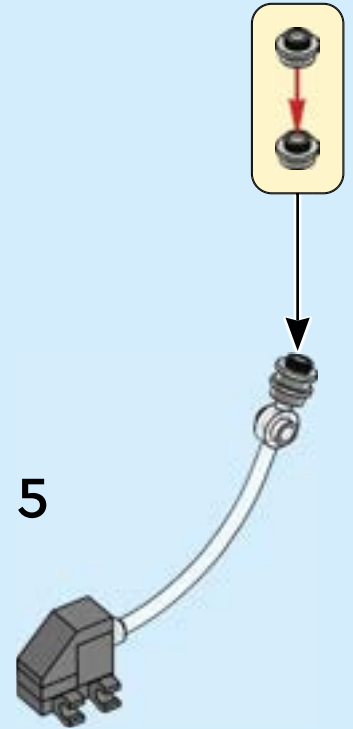

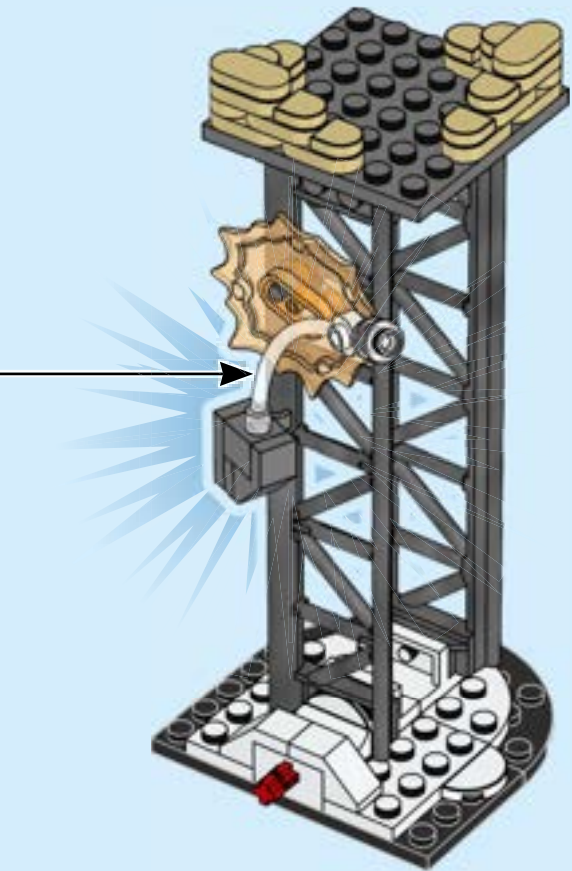

13

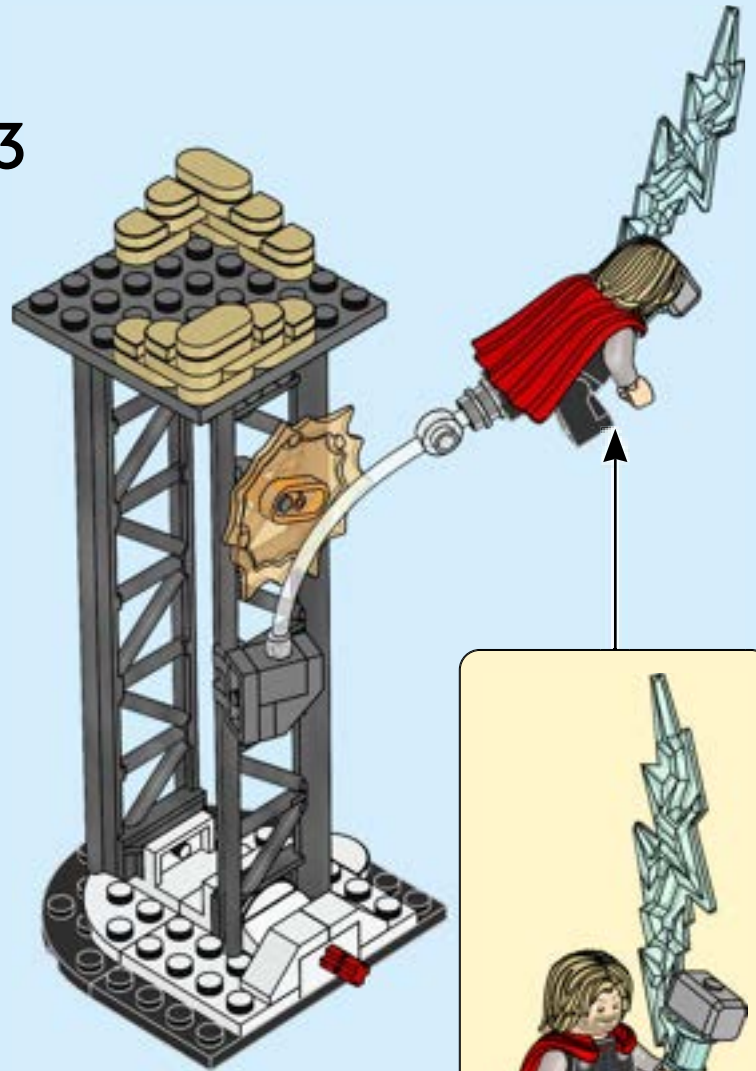



1



2

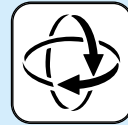

3

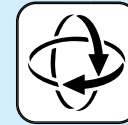

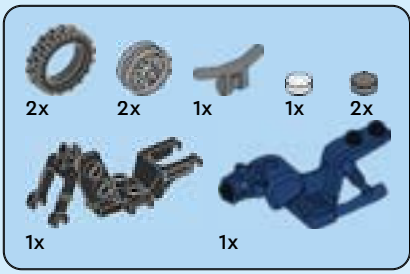

1



2



3

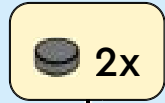

4

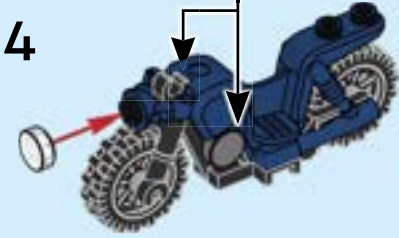

5



6



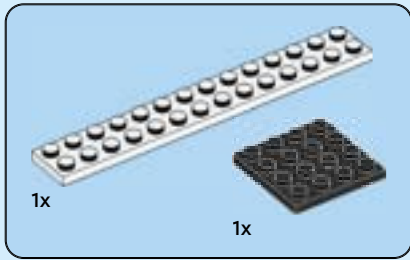
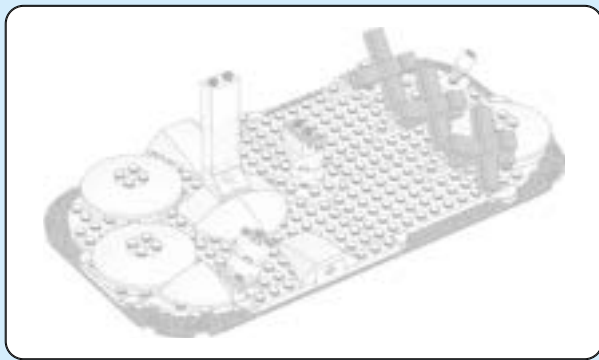

1

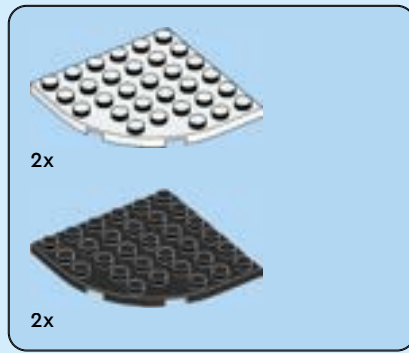
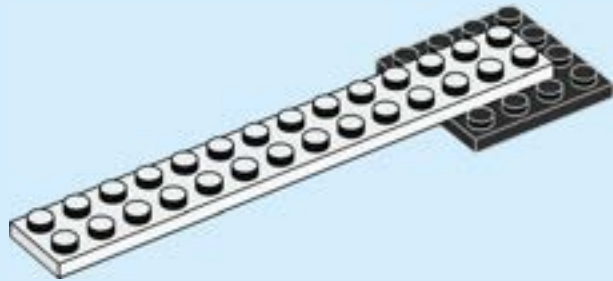

2

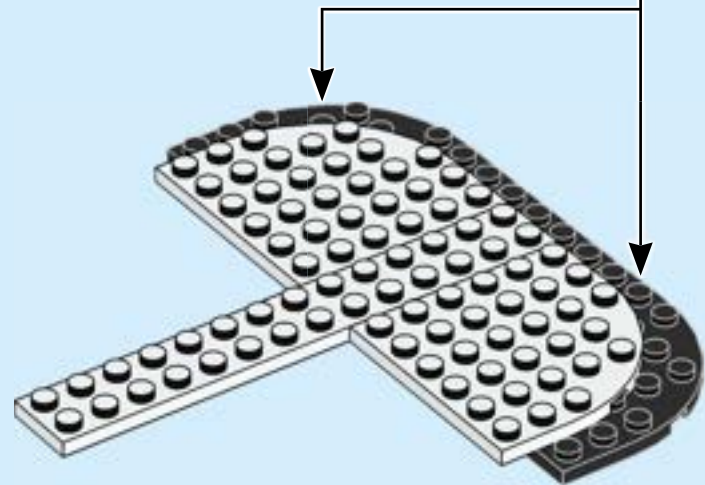
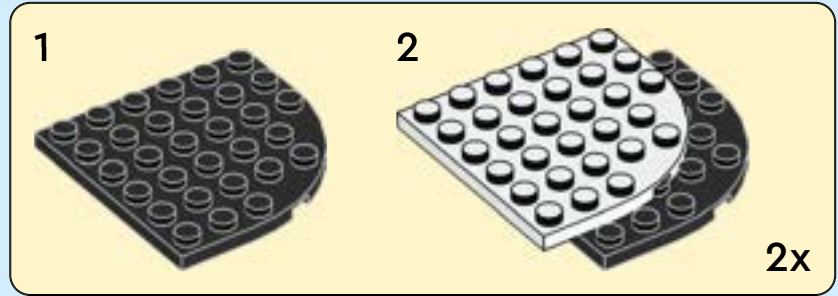

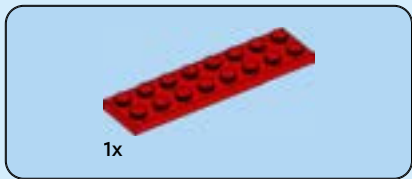

3

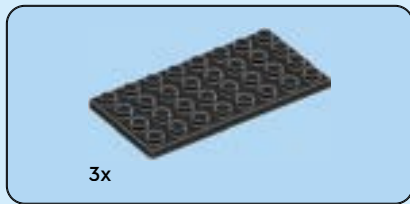
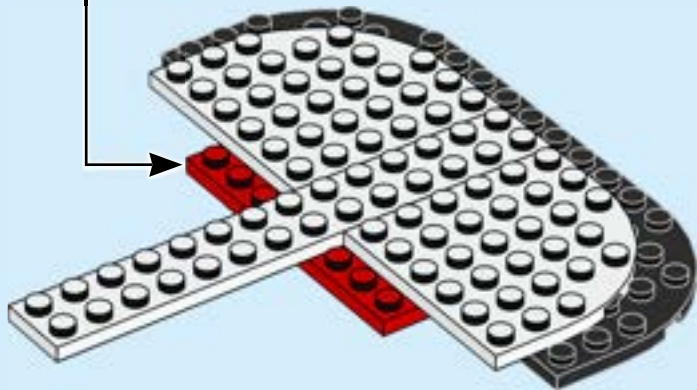
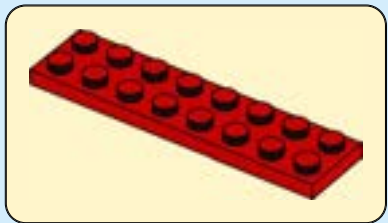

4

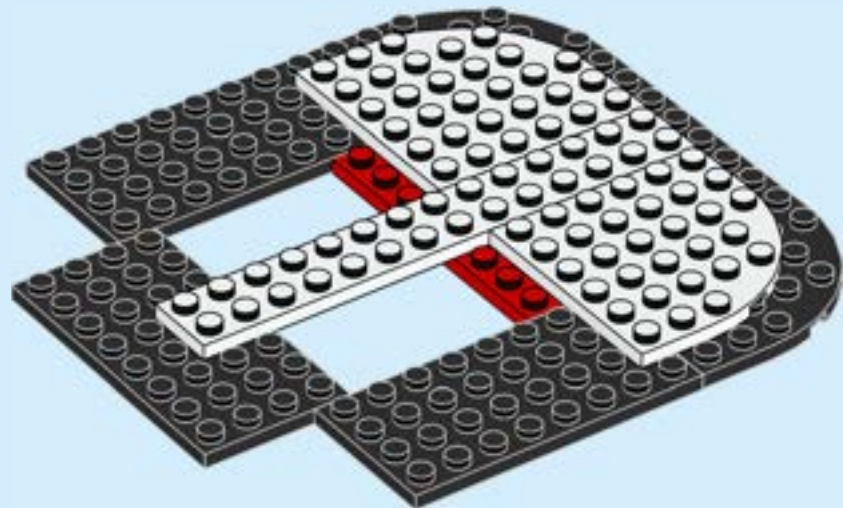

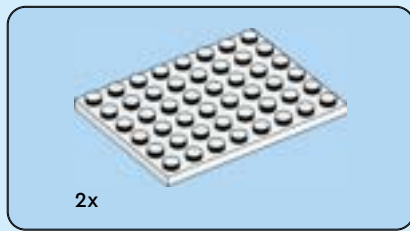

5

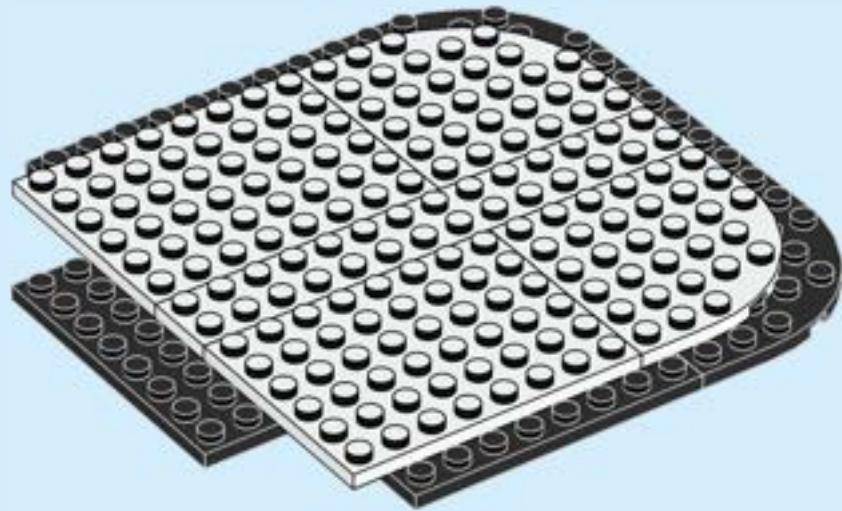

6

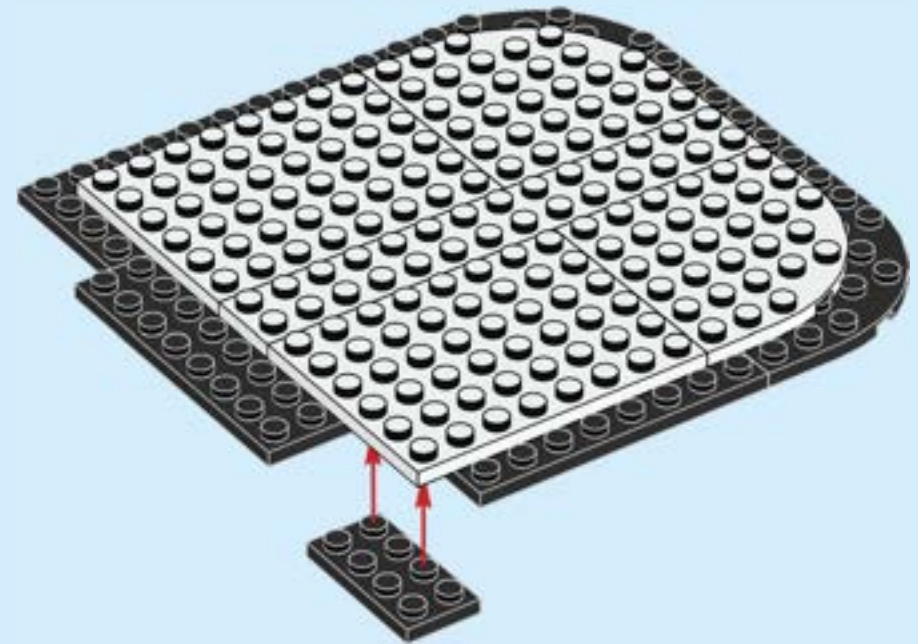

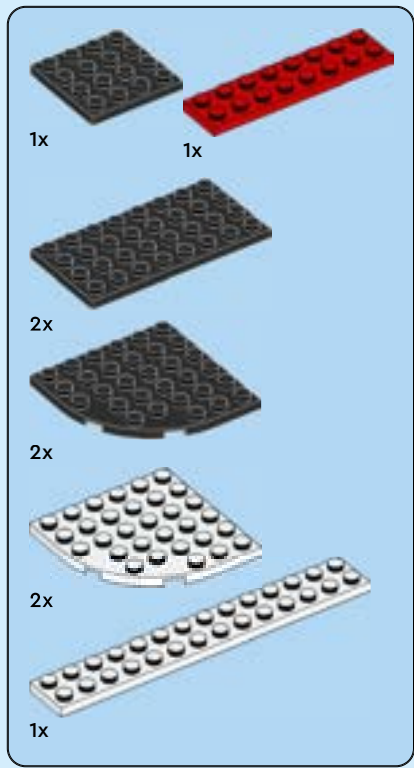

7

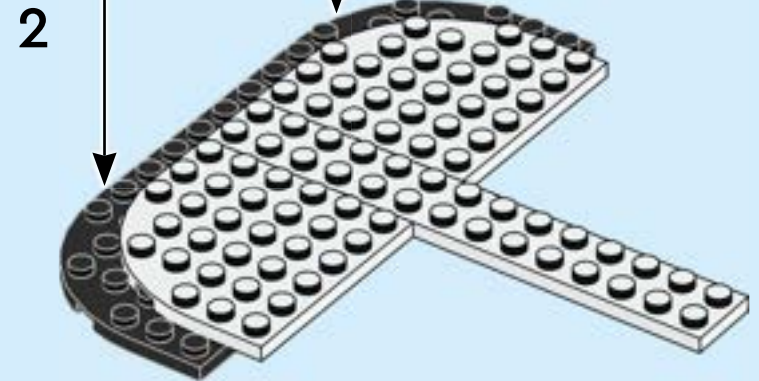
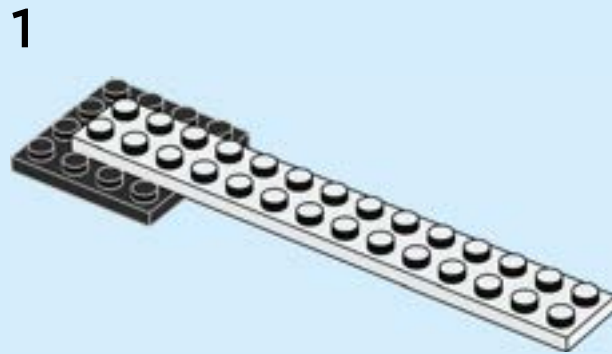
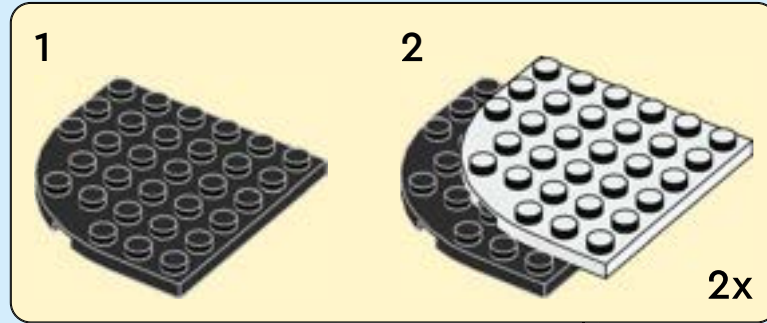

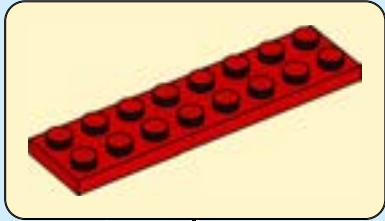

3

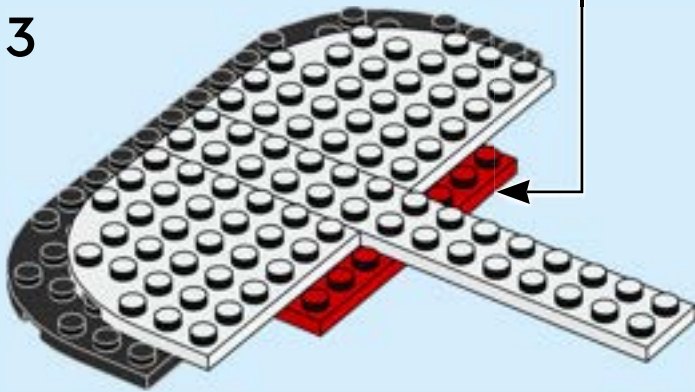

4

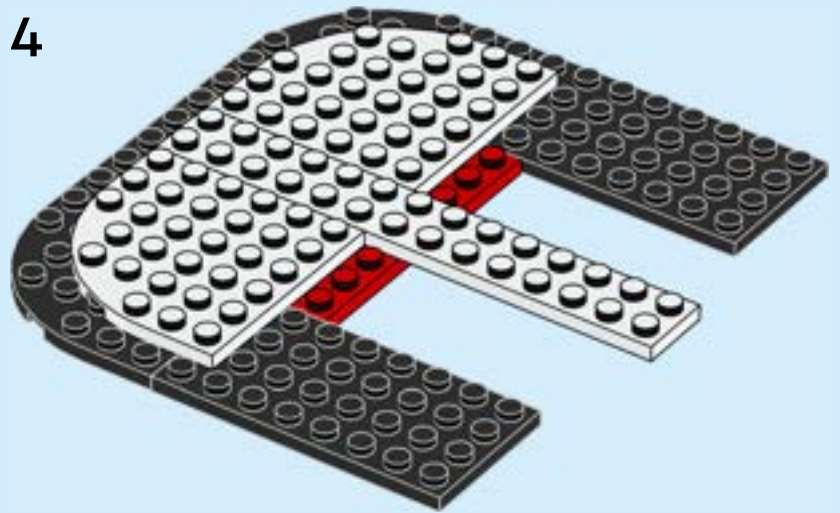

8

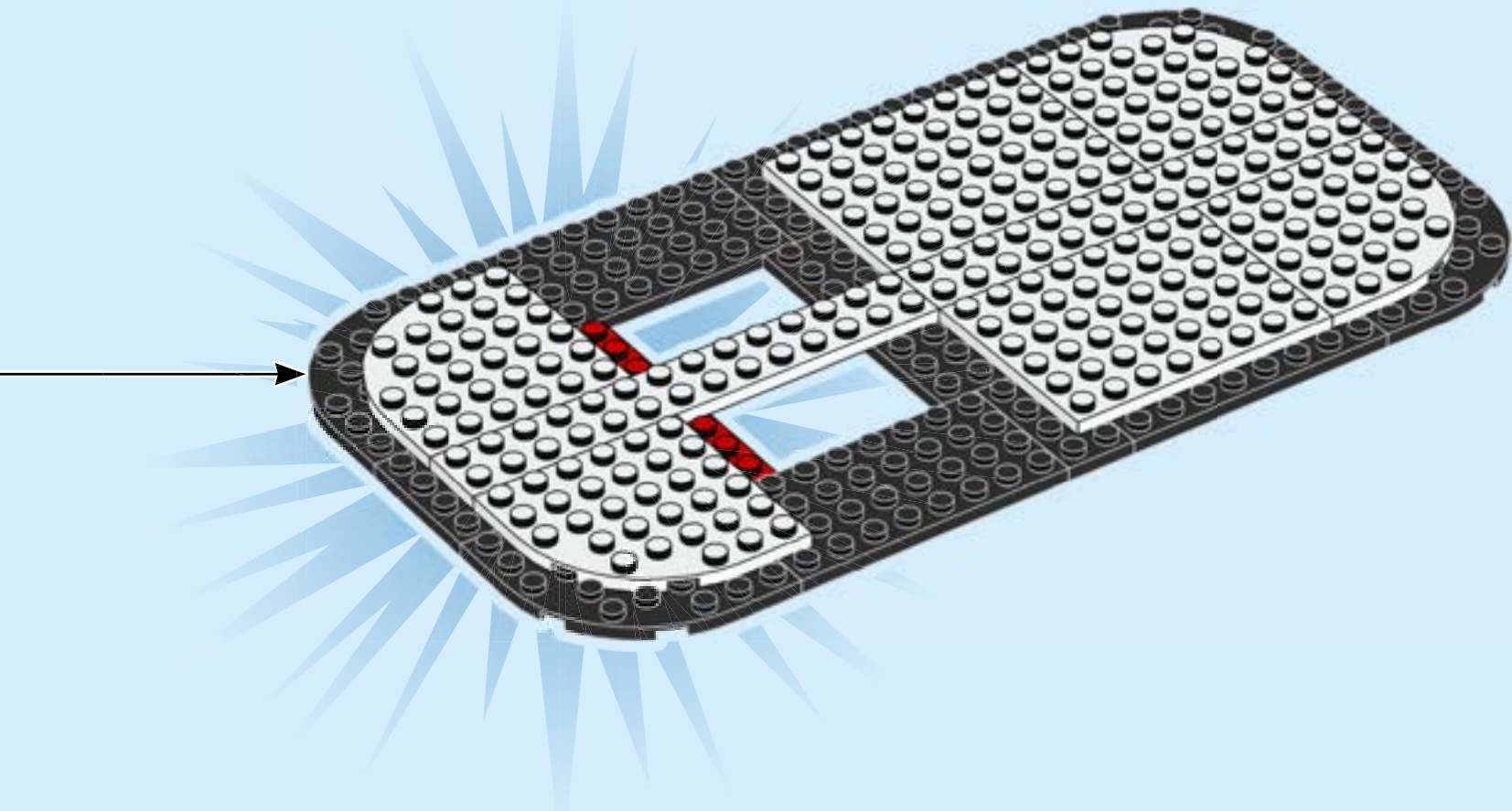

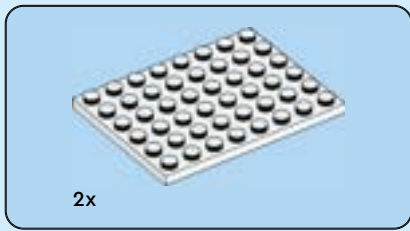

9

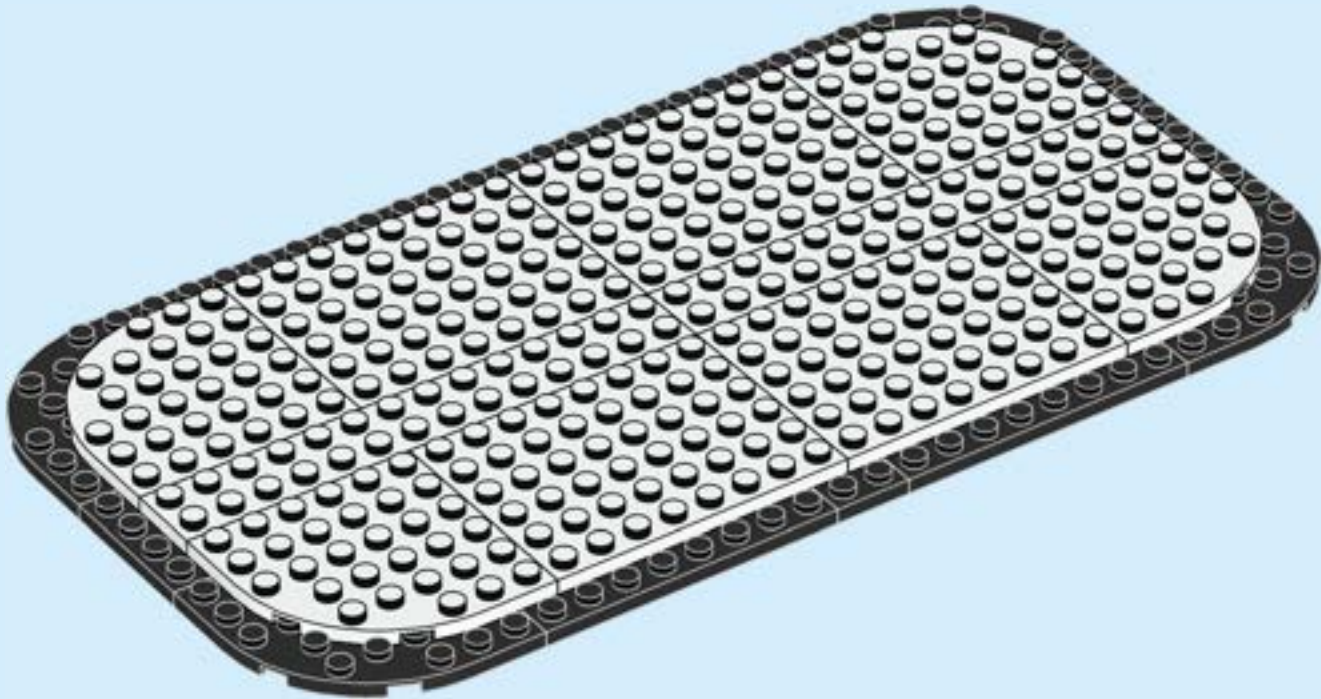

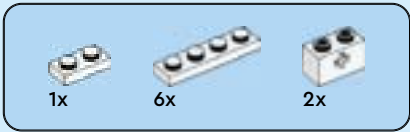

10

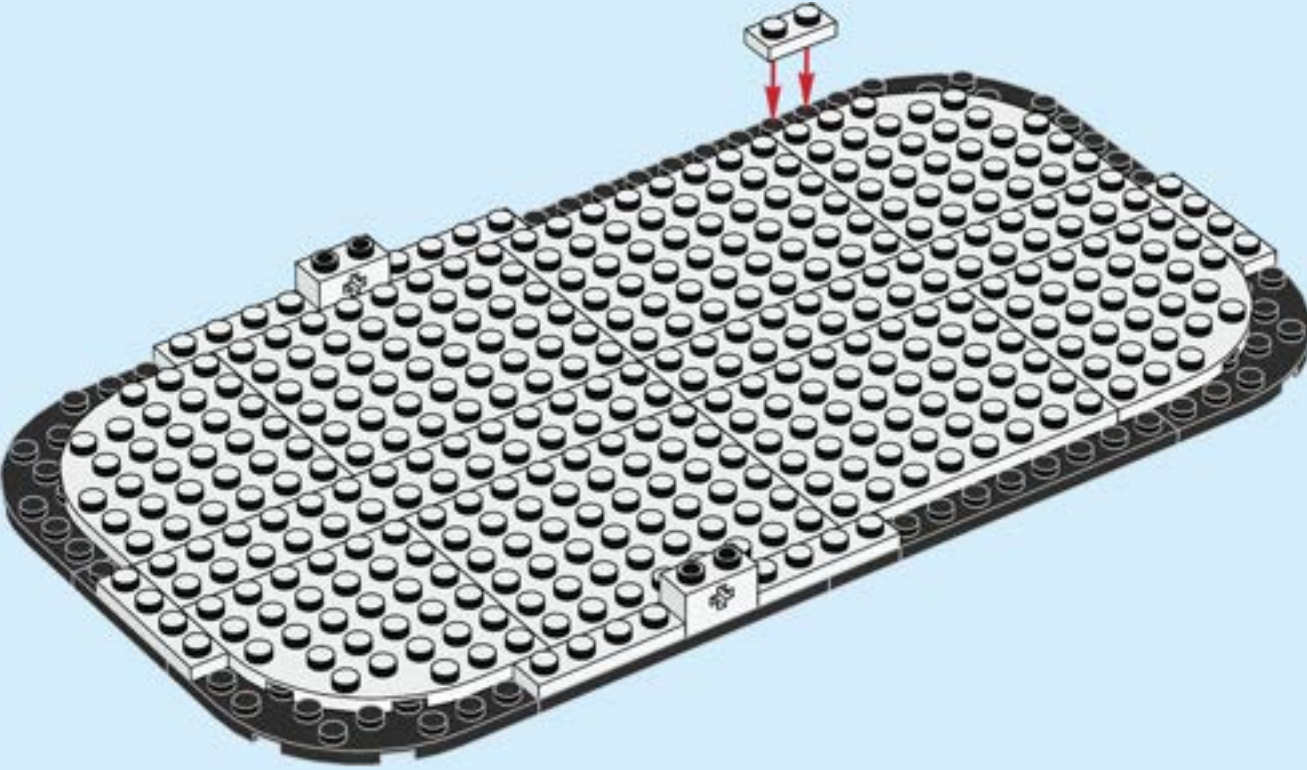

10x 1x

11

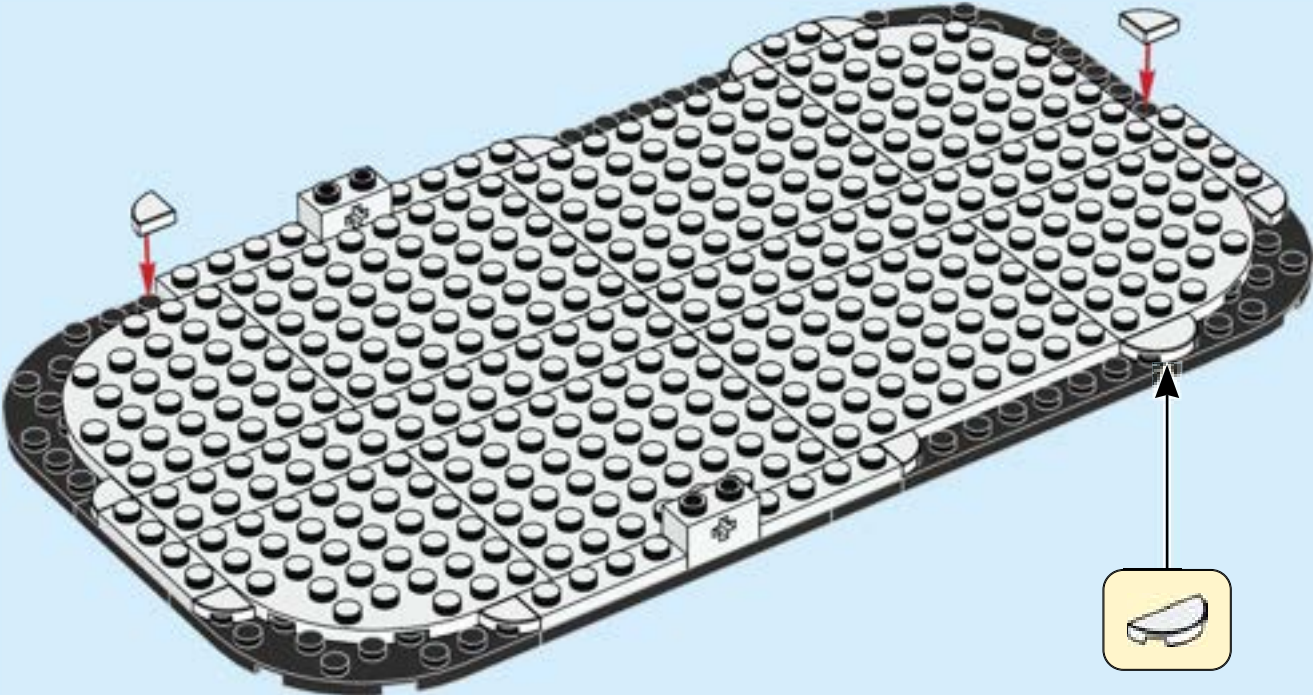



2x

12

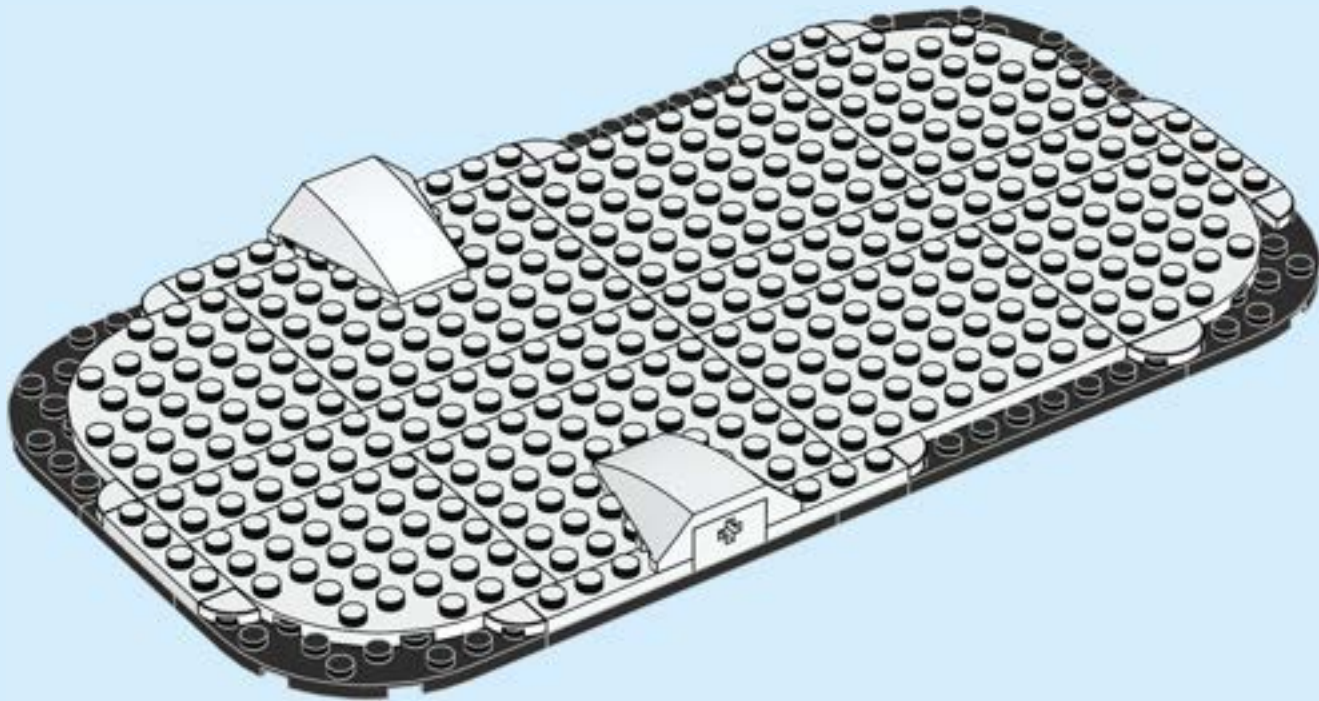



13

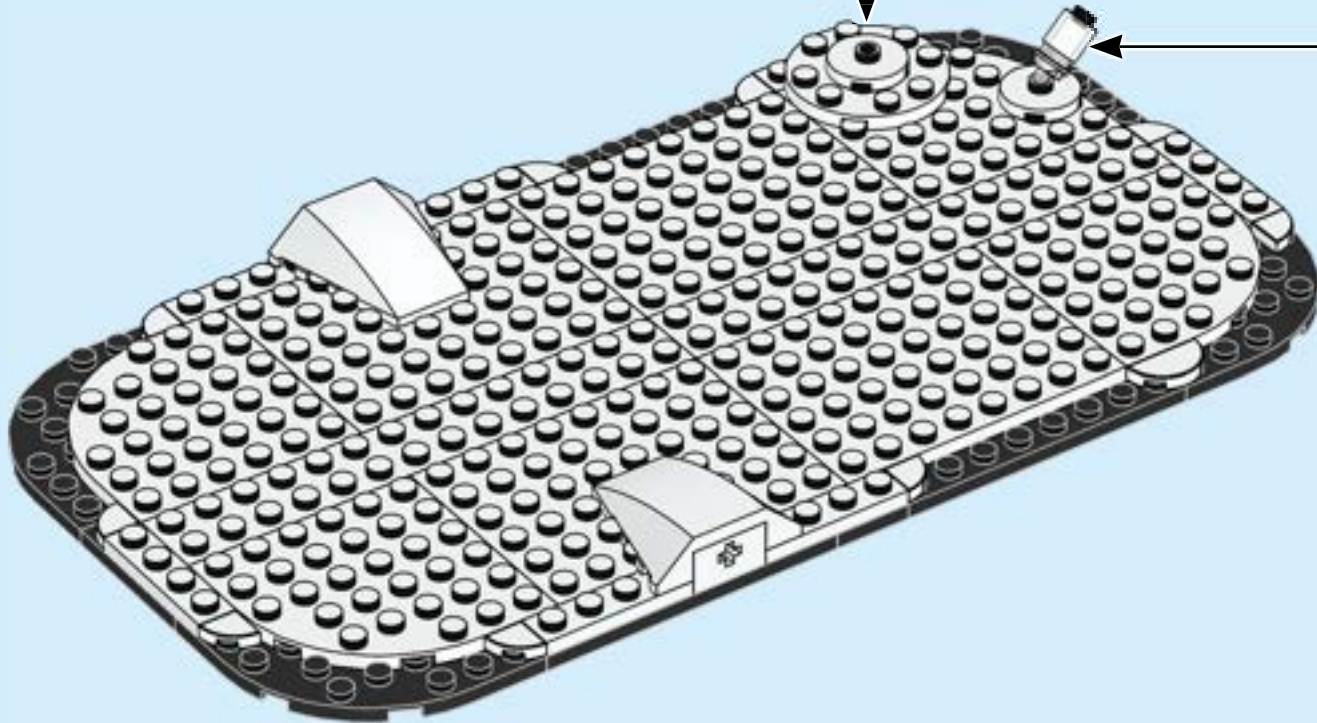
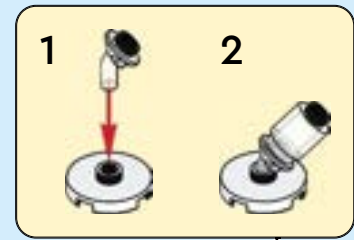

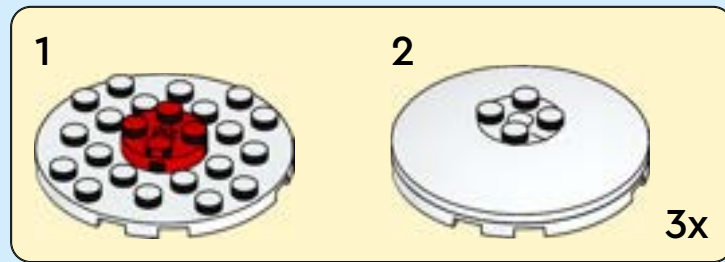
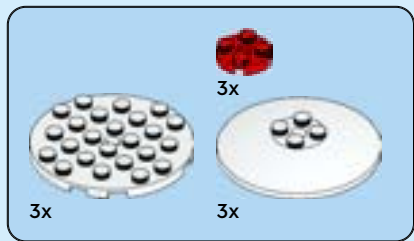

14

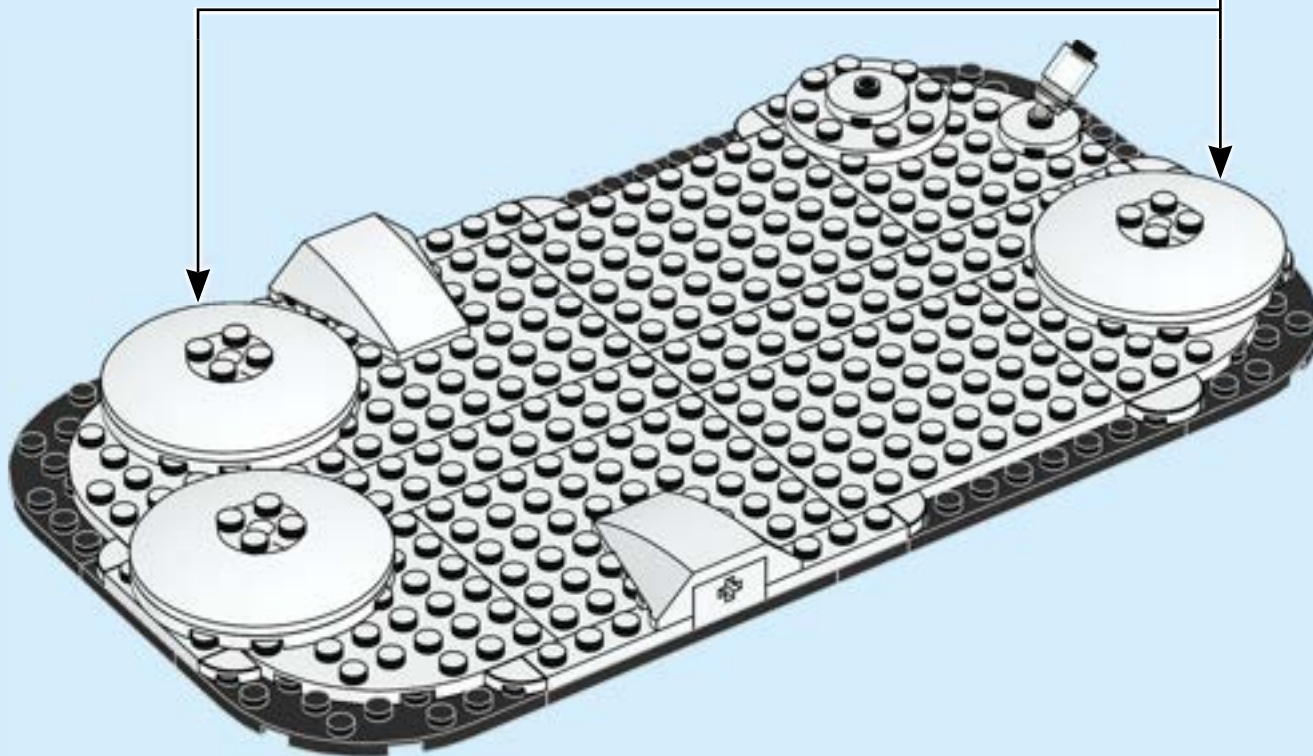

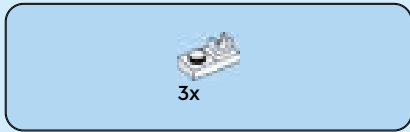

15

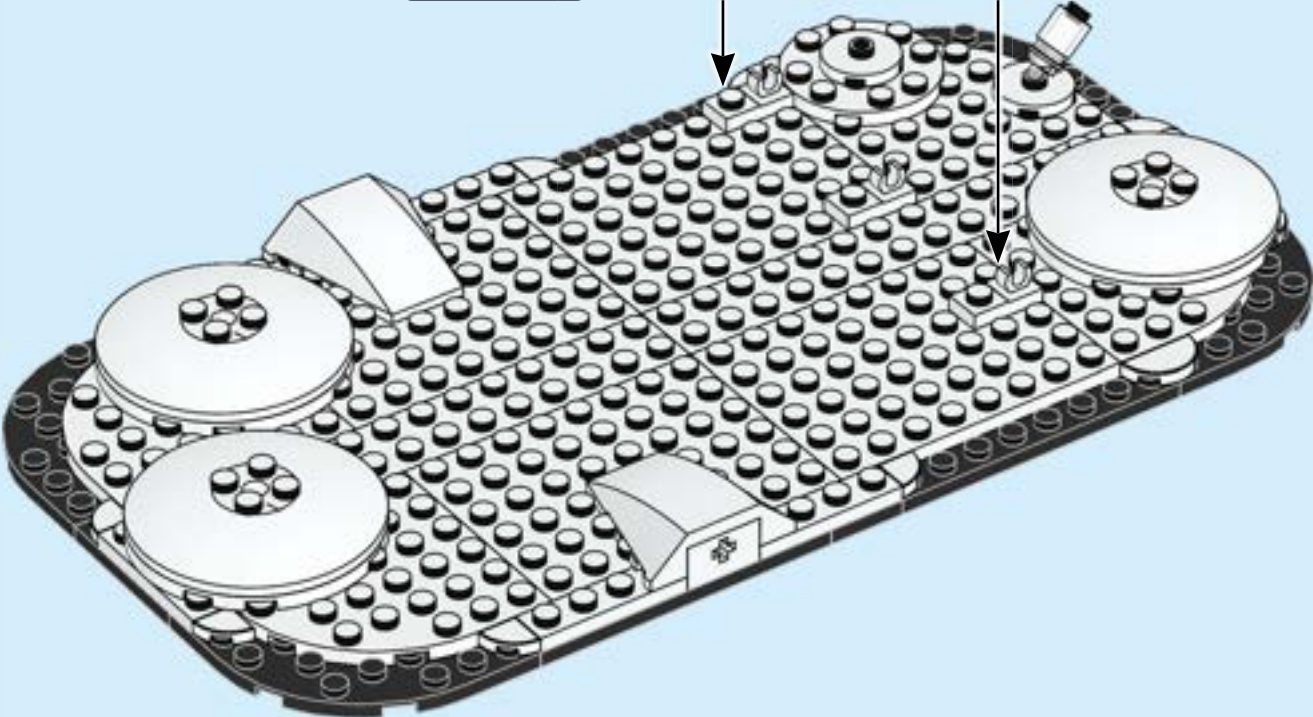

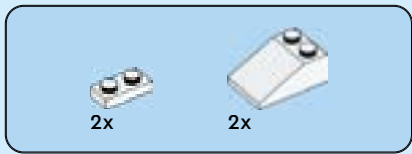

16

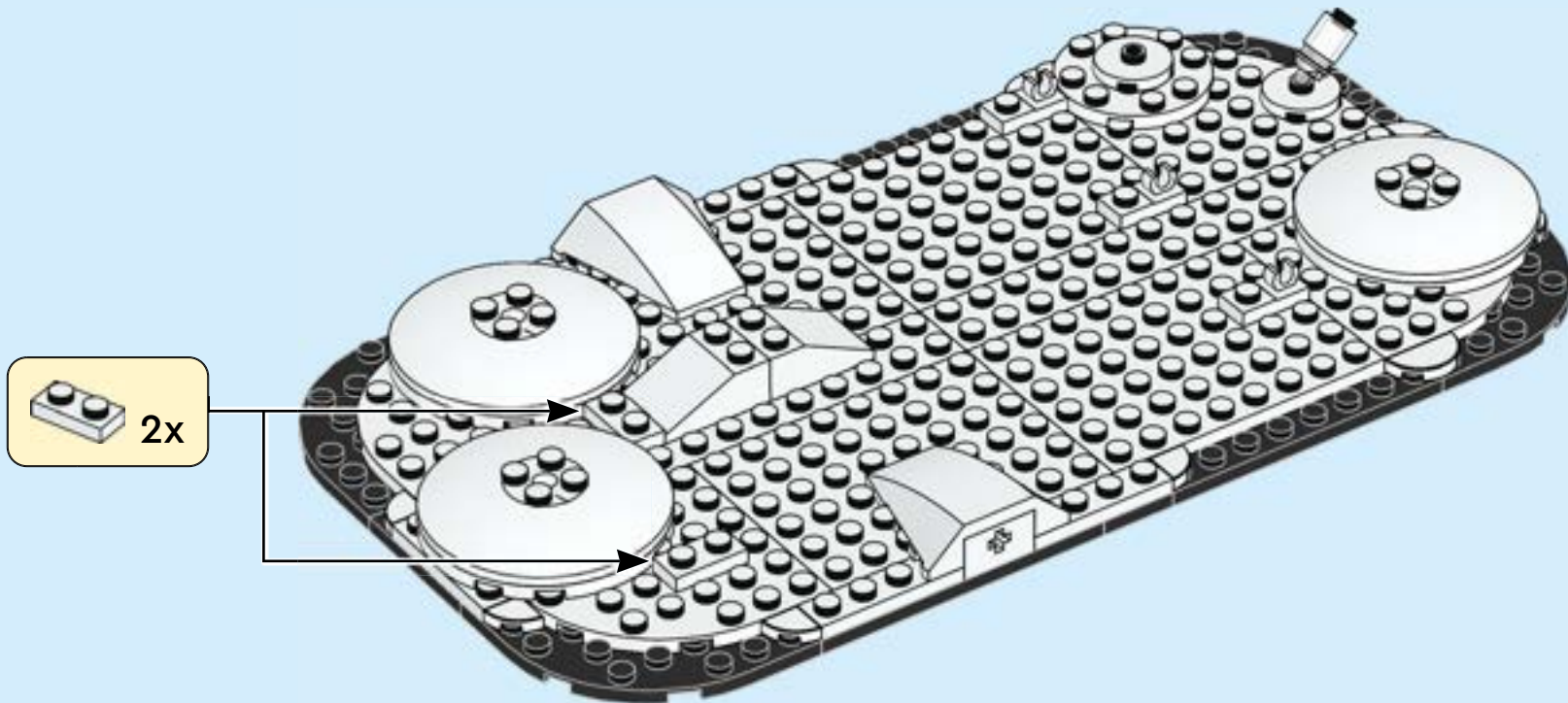

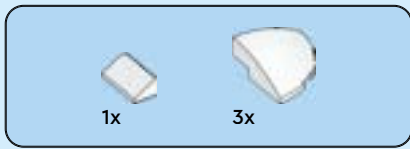

17

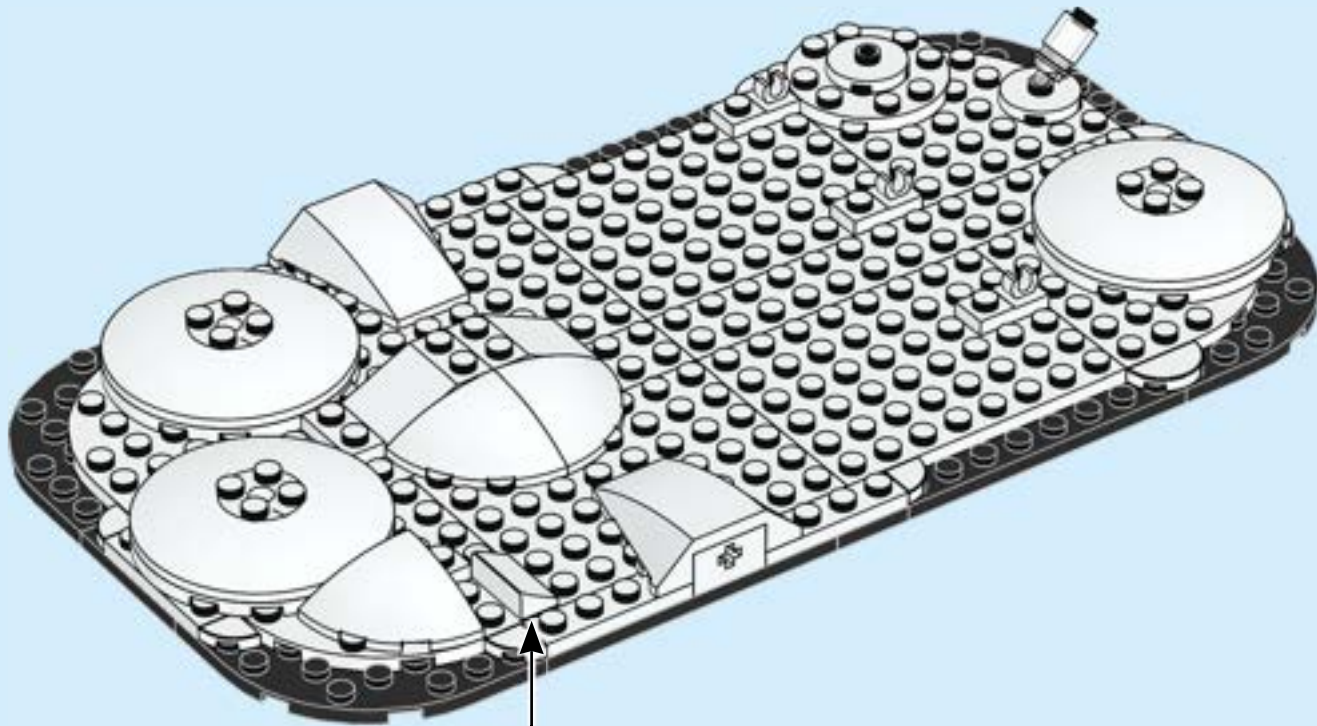



18

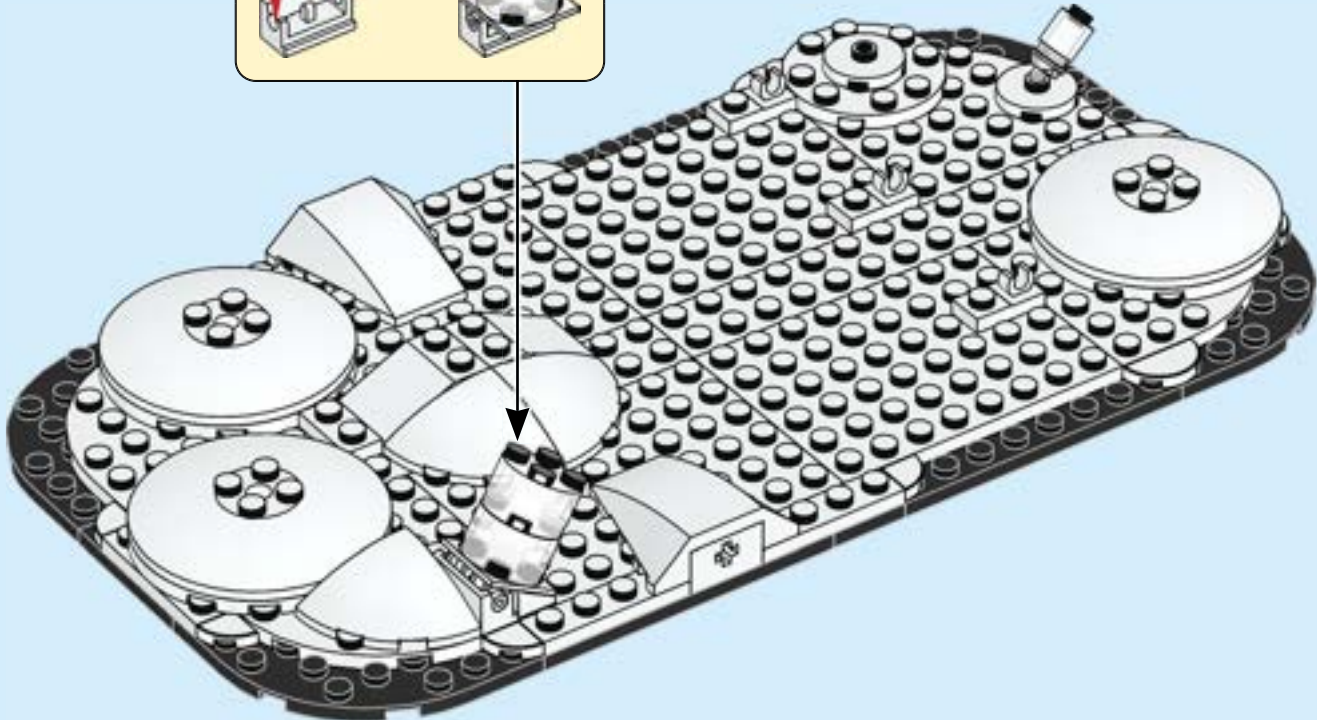
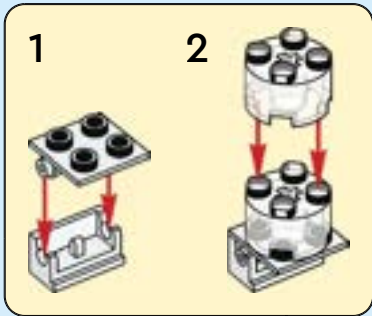

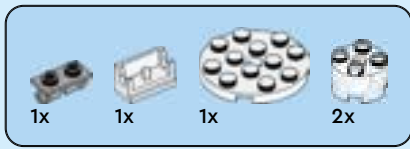

19

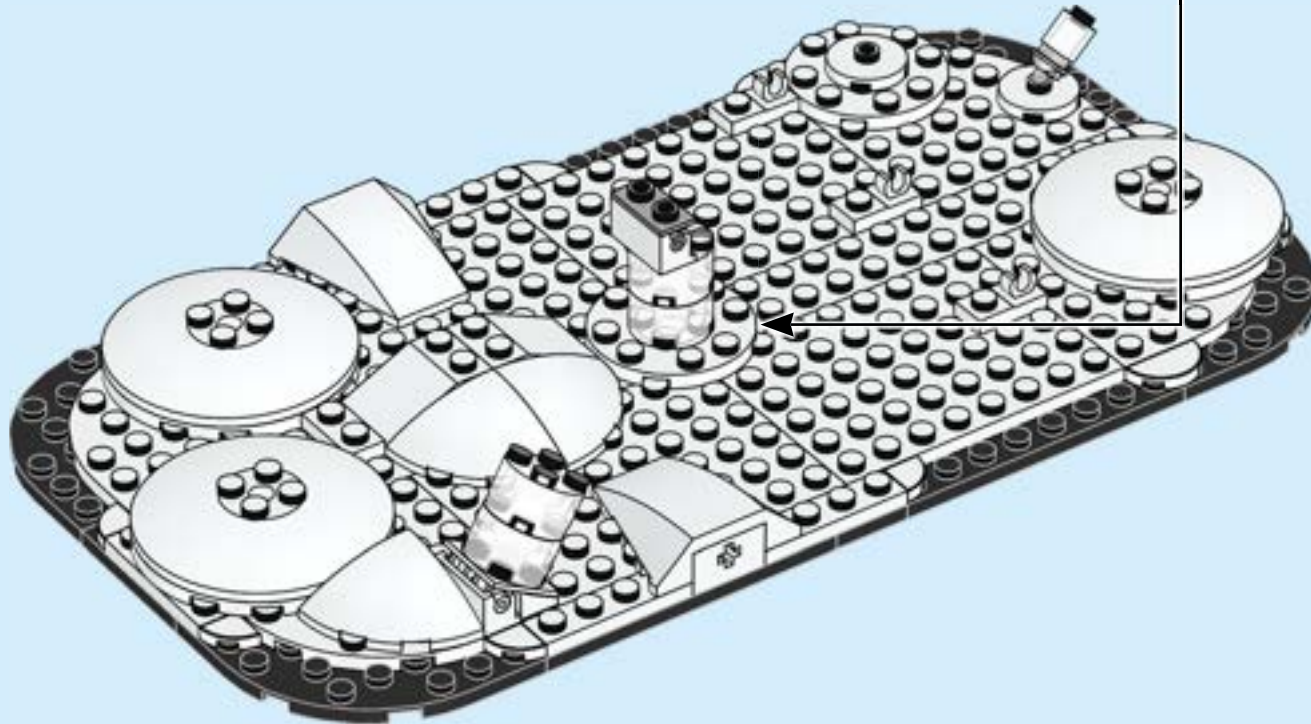
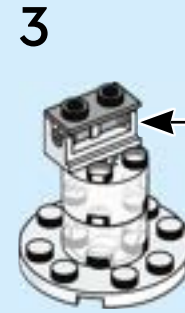

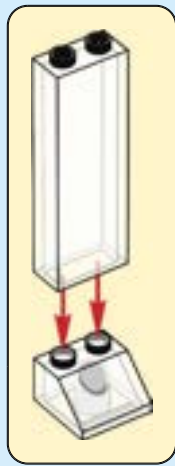
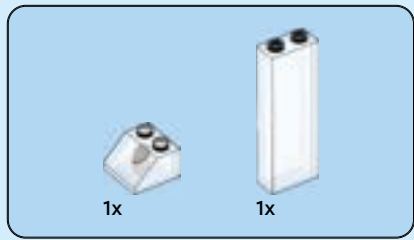

20

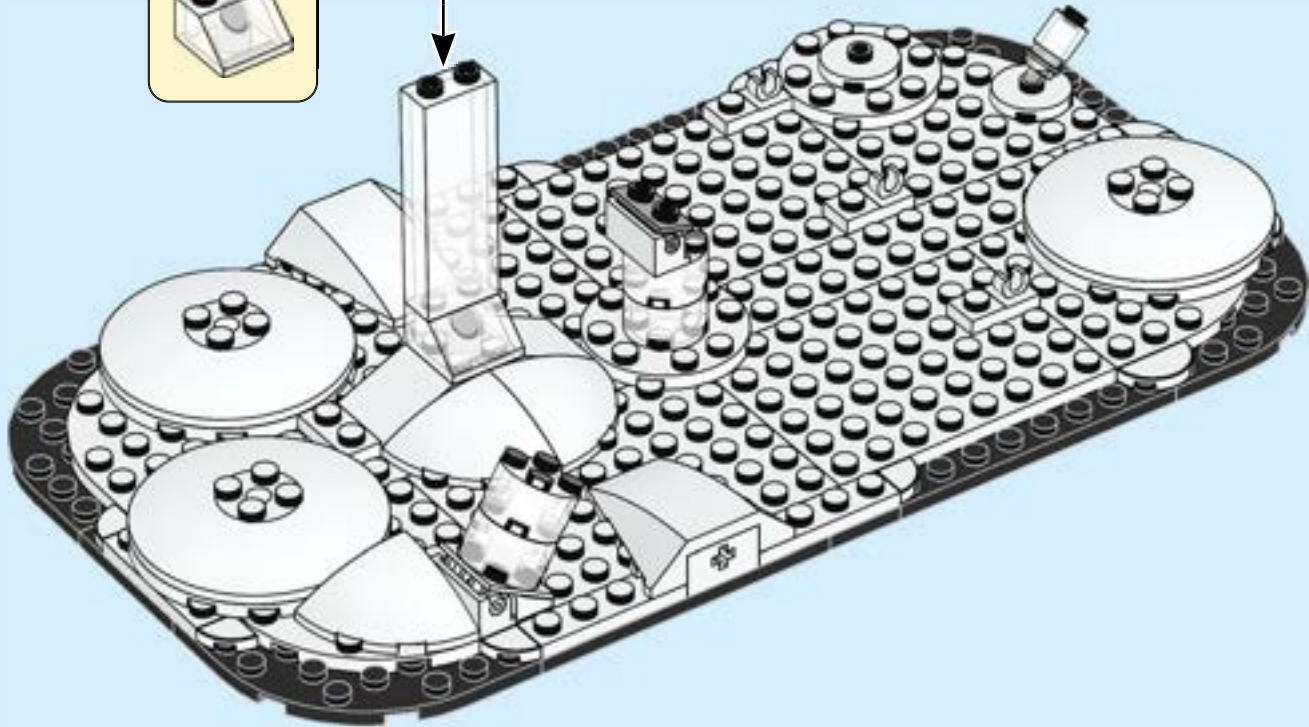

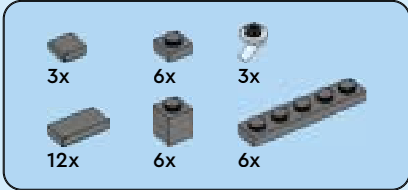

21

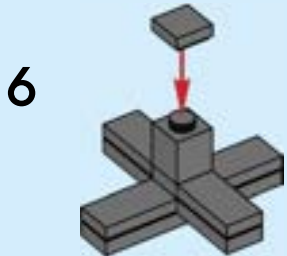
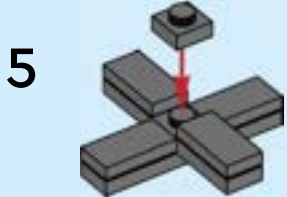
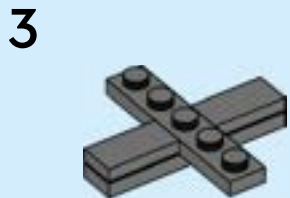
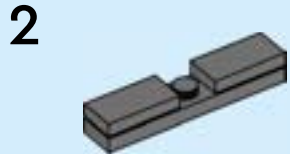
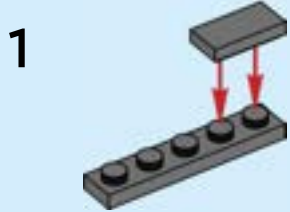

7

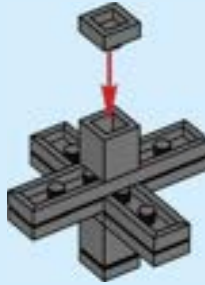

8



3x

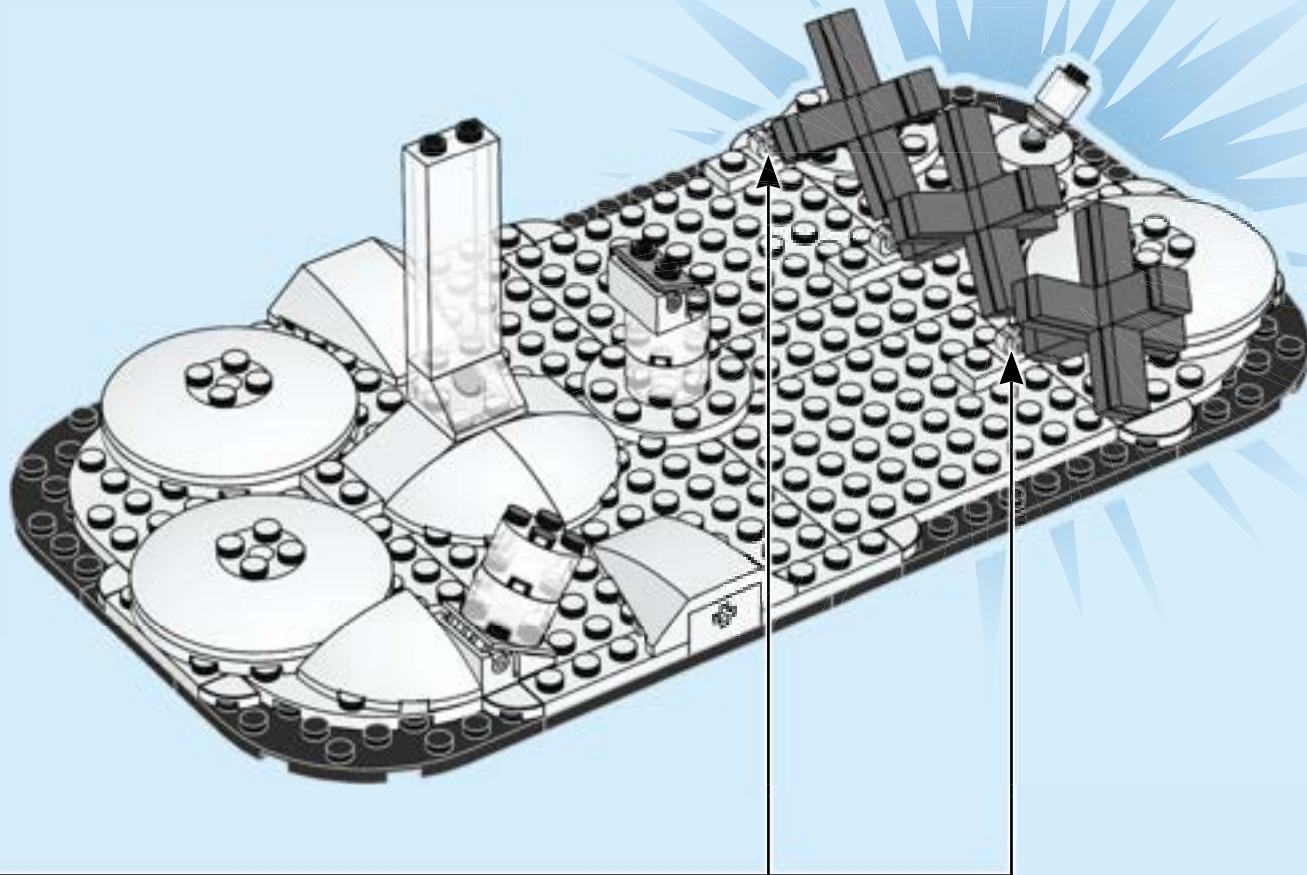

22

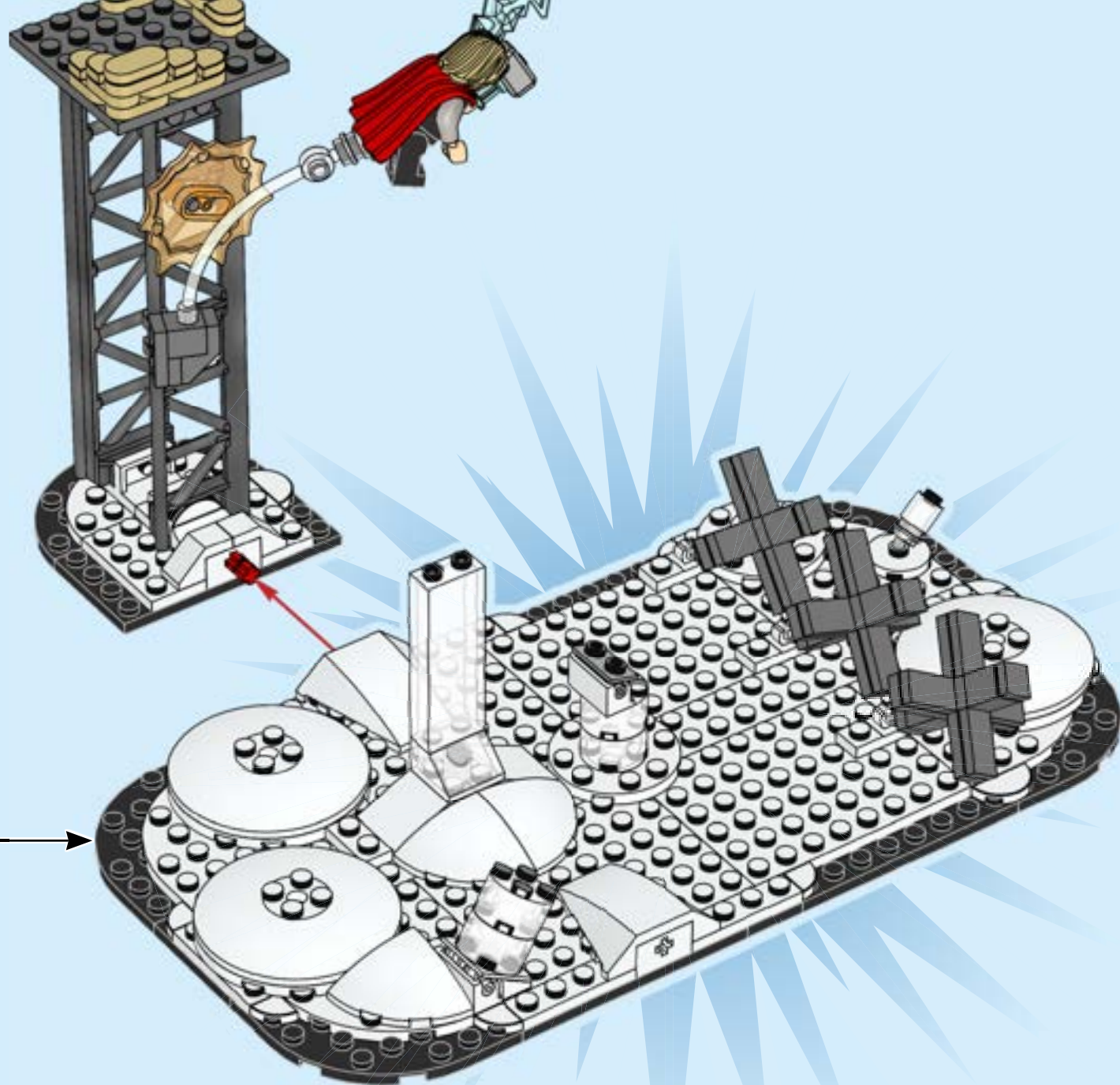

23

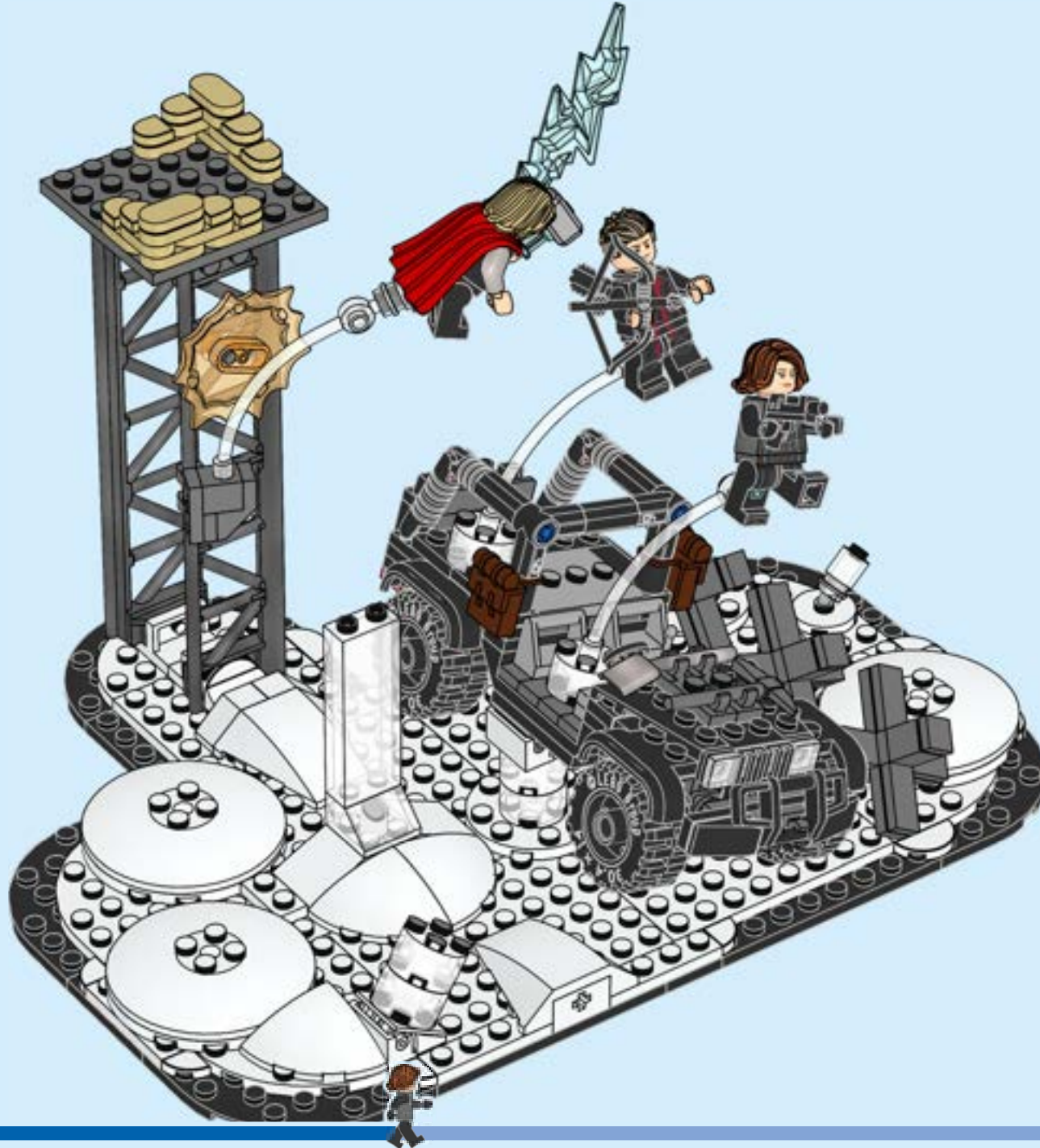



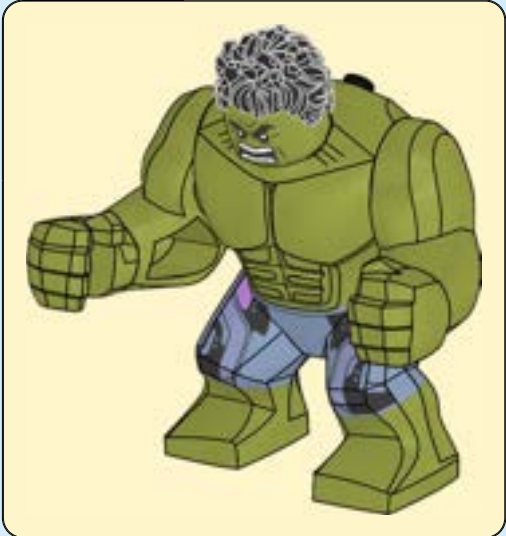
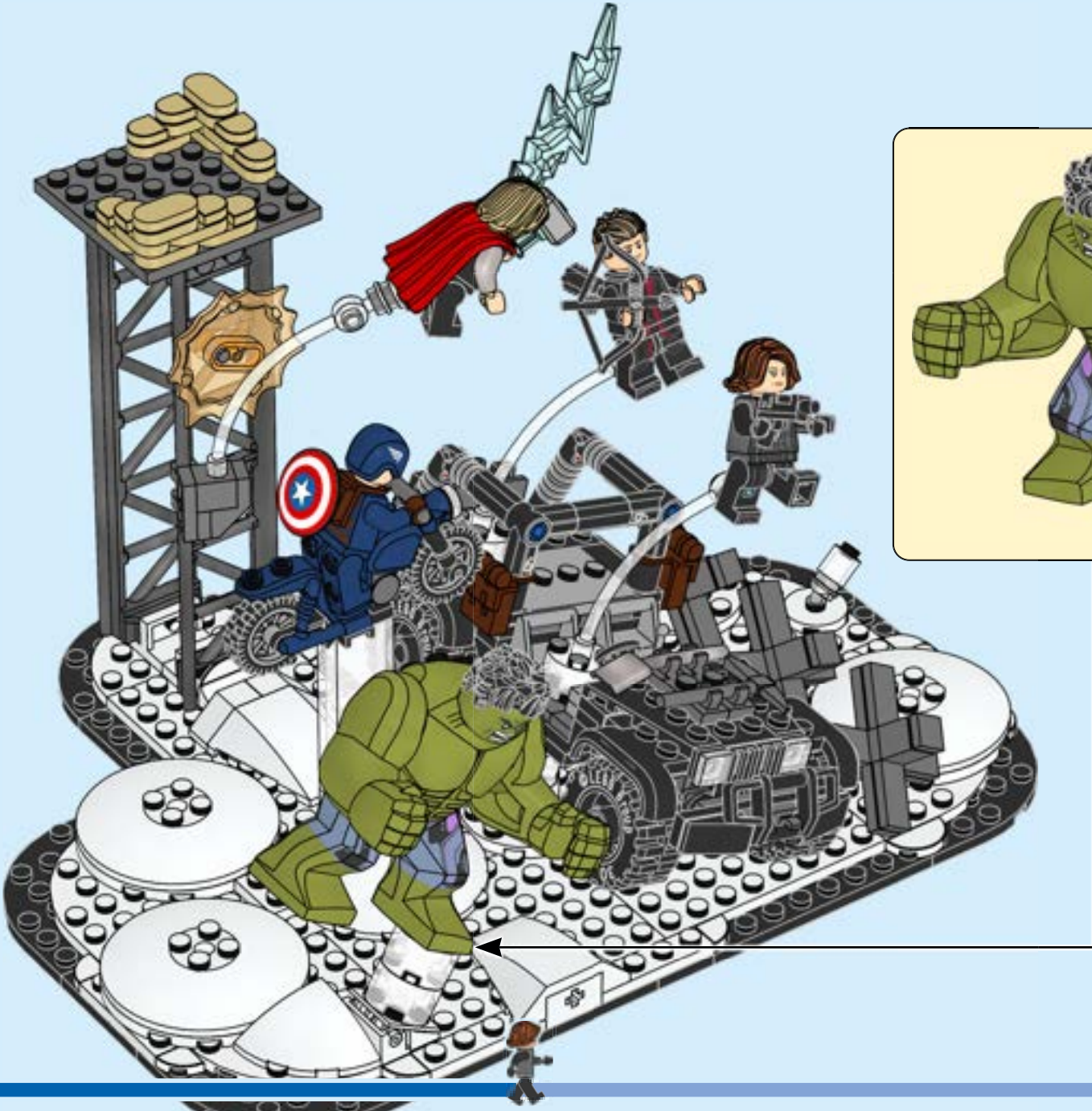

26



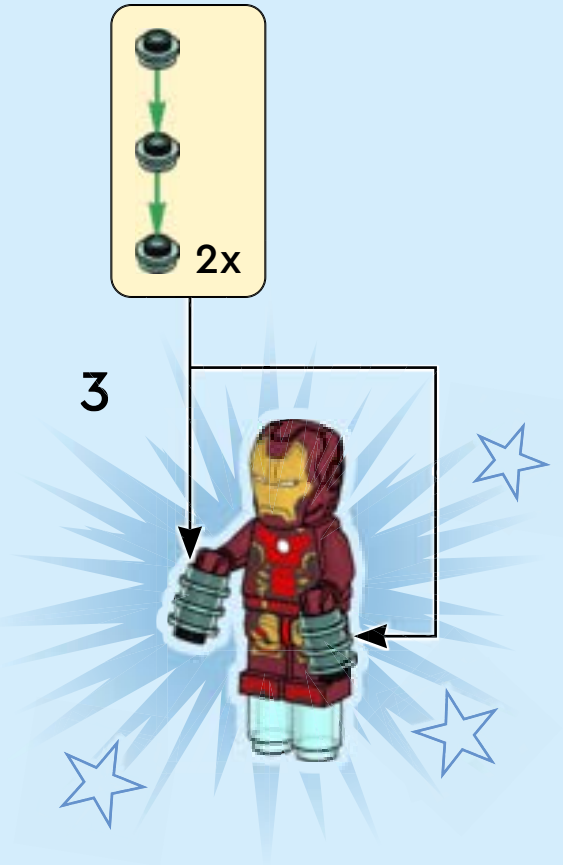



27

1

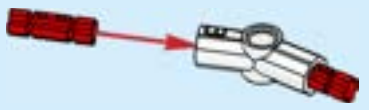

2



3



4







28

1



2



3

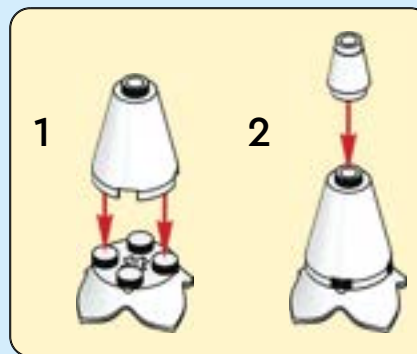

4





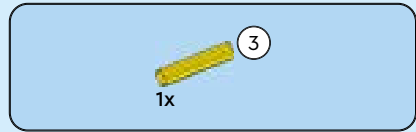

29

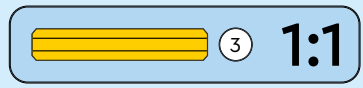
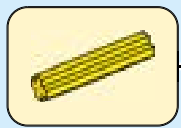



5x

30

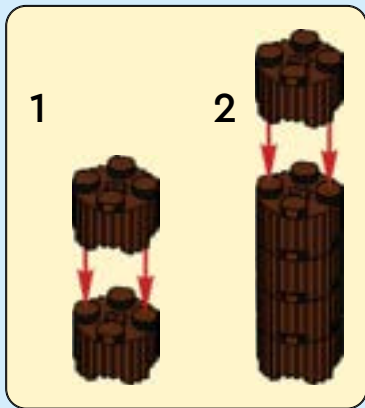
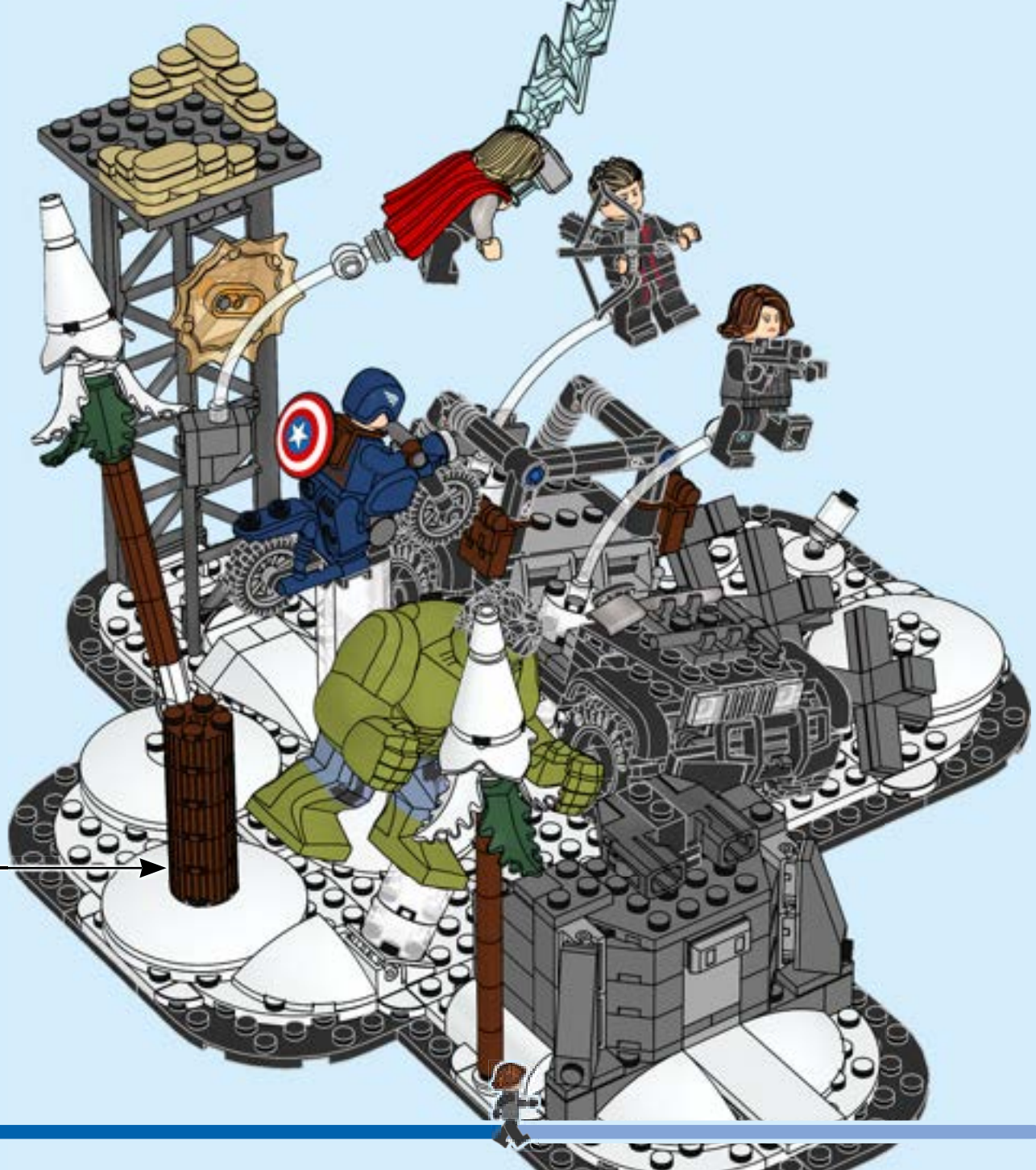

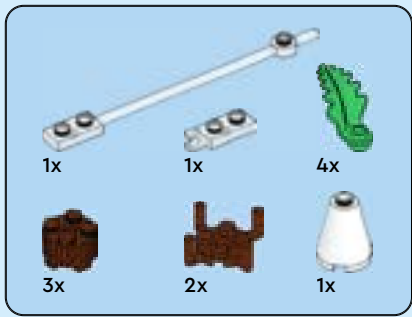

31

1



2



3



4



5



6



7



8

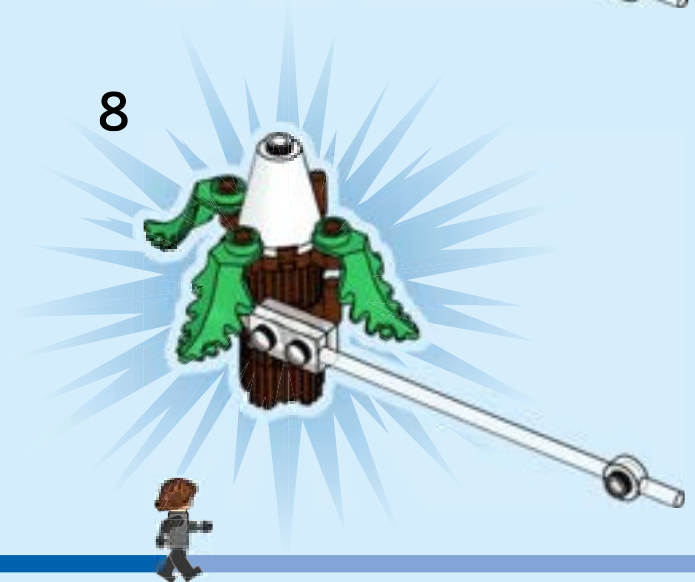





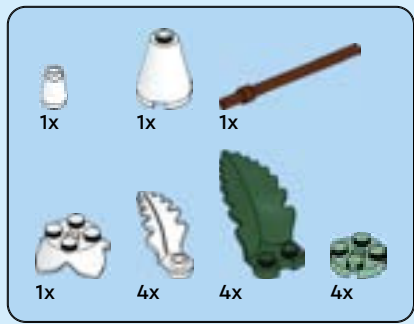

33

1



2



3

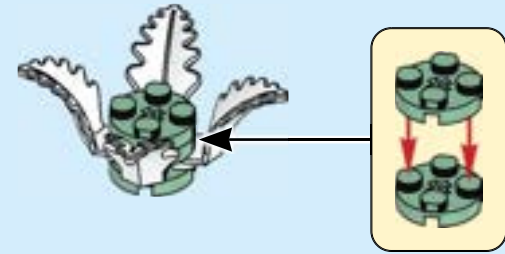

4



5



6



7



1



2



8

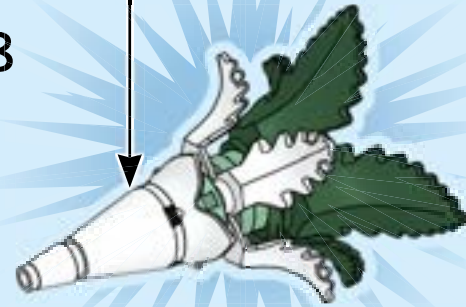
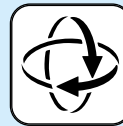



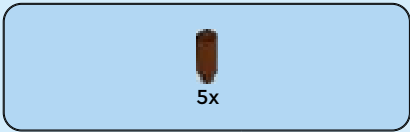

34

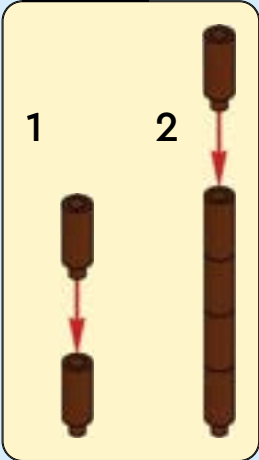



35

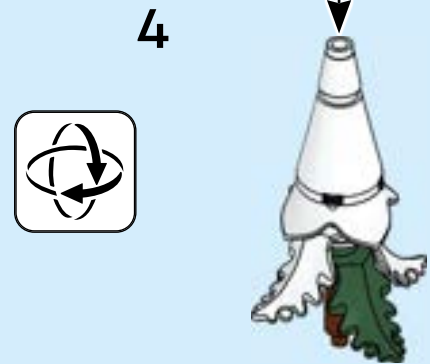
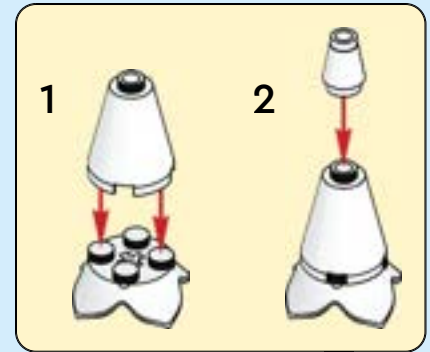
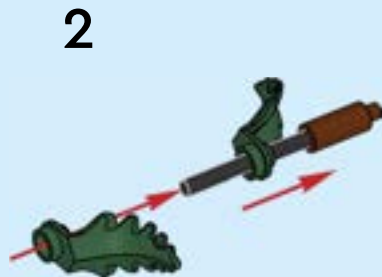



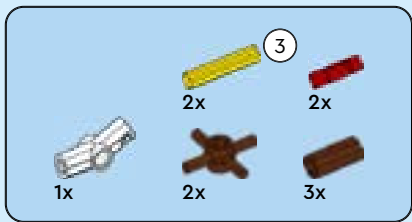

36

1



2



3

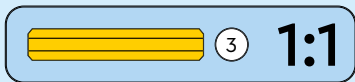

4



5



6





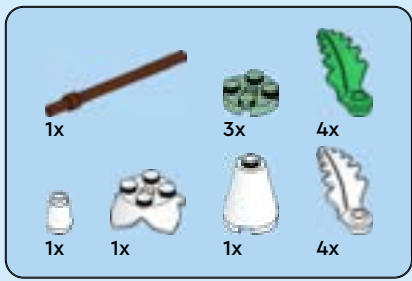

37

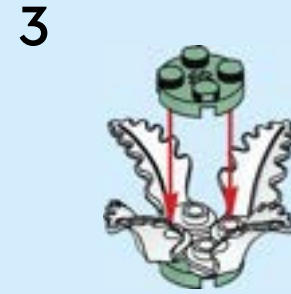

4



5



6

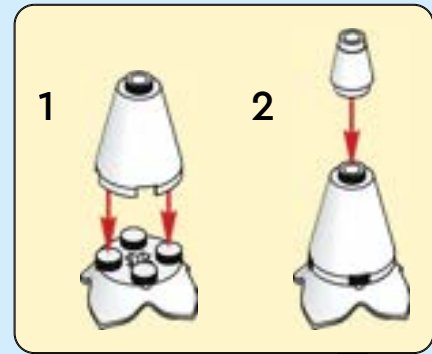

7

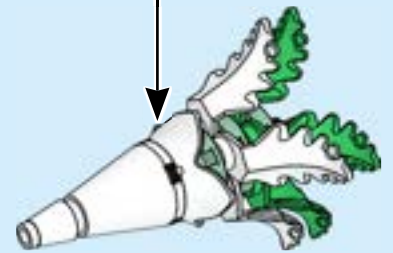
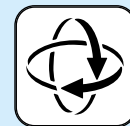



6x

38







5x 4518400
3x 6168642
12x 6172366
3x 6252744
4x 6510068
3x 4547489
6x 6044601
2x 6093053
14x 6439714
3x 6347309
4x 6178921
1x 6051511
3x 302301
2x 393701
2x 6250019

4x 6166894
5x 6468789
3x 6365712
2x 302201
2x 4612342
5x 6334524
3x 6502815
2x 329801
8x 371001
2x 4515347
2x 608101
3x 302001
2x 6002767

2x 6261390
1x 6192352
2x 4178429
3x 6109817
3x 4514791
1x 6332042
4x 6057460
1x 383201
4x 303601
2x 6359065
6x 4206482
3x 6130007

8x 6353196
1x 6294704
2x 6507789
12x 6212758
15x 4142865
5x 403221
1x 6508620
2x 303421
2x 6510193
2x 6121485
2x 6265699
1x 4161332
1x 4160869
4x 6170597
2x 302026

1x 6103643
2x 6483559
4x 6271535
1x 4253815
1x 9339
1x 6488118
3x 4512363
2x 6268905
2x 6092585
4x 6338799
1x 4226995
2x 241226
2x 300426
1x 6430626
1x 6020193

4x 4504382
4x 6299338
2x 6064174
1x 6268961
1x 368026
4x 6109682
1x 6450613
2x 4558170
2x 6097283
1x 6395354
1x 6510888
1x 6168620
3x 6116604
1x 6359942
1x 302126

4x 4619323
3x 366626
2x 6064228
2x 4243819
2x 6101857
3x 379526
1x 6298539
6x 6137779
6x 303526
1x 6170384
1x 302826

1x 6274738
1x 6223655
2x 6449836
4x 6510188
2x 6254254
6x 6273152
1x 6166106
1x 6251285
1x 6358934
1x 6244886
3x 6444527
1x 6276993

8x 6411022
1x 6115306
2x 6514003
2x 6238677
6x 6283590
1x 6508017
14x 6325432
1x 6444360
1x 6035540
1x 6488122
1x 4162916
1x 6357647



1x
6489304



6x
6447541



4x
6507852



1x
6488204



1x
6398321



1x
6488206



1x
6501829



1x
6327465



12x
6422088



1x
6348057



1x
6170809



8x
6036503



2x
6268828



7x
4531751



2x
6316697



2x
6313506



2x
6170468



1x
6267587



2x
6258831



3x
6488120



1x
6004729



2x
6410997



1x
4211492



1x
6329152



1x
4540203



3x
4227657



5x
4211469



4x
4211398



1x
6134378



5x
4211470



2x
4211357



4x
4211881



1x
4211491



1x
4211396



2x
4211394



1x
6372029



1x
6079461



2x
6408542



7x
6223237



2x
6284596



4x
4210633



1x
6439040



5x
4210848



4x
6228923



2x
4504378



6x
4211098



7x
4210719



1x
6362259



2x
6344022



2x
6225494



5x
6360675



4x
6388118



1x
6261471



2x
4211135



3x
6146225



2x
4211088



16x
4211052



2x
6069164



1x
6168776



4x
4211066



3x
6214341



1x
6350292



1x
4261908



1x
4211007



8x
4210635



8x
4624186



2x
4211104



2x
4211104



2x
4211104



2x
6118832



6x
4211105



2x
4218188



2x
6210601



2x
6210601



2x
6210601



2x
4210897



2x
6365692



8x
6343852



1x
6092649



2x
4535930



2x
4211065



6x
6413109



1x
4521572



1x
4211134



2x
6190252



2x
6210601



2x
6210601



2x
6210601



2x
6210601



2x
6210601



2x
6210601



1x
6350081



1x
6288611



1x
6221340



1x
6118815



1x
6163442



1x
6444161



1x
6447635



2x
6345952



2x
6287323



1x
6240515



1x
6240515



1x
6240515



1x
6240515



1x
6240515



1x
6240515



1x
6240515



1x
6488087



1x
6459214



1x
6459215



1x
6459213



1x
6459212



1x
6459212



1x
6488124



1x
6488124



1x
6488124



1x
6488124



1x
6488124



1x
6488124



1x
6488124



1x
6488124



1x
6488124



1x
6488124



2x
6287323



1x
6240515



[LEGO.com/service](https://www.lego.com/service)

YOU COULD **WIN**

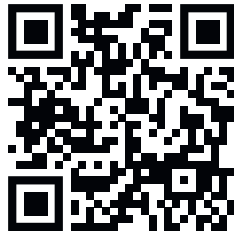

Scan this QR code or go to **LEGO.COM/PRODUCTFEEDBACK** and give us your short feedback about this LEGO® set for a chance to win a cool LEGO prize.

Terms and Conditions apply*

EN: YOU COULD WIN. Terms and Conditions apply* **DE: Du könntest GEWINNEN.** Es gelten die Teilnahmebedingungen* **FR: Tu pourrais GAGNER.** Des conditions s'appliquent* **IT: Potresti VINCERE tu.** Termini e condizioni sono applicabili* **ES: Puedes GANAR.** Aplican términos y condiciones* **PT: Poderá GANHAR.** Aplicam-se termos e condições* **ZH: 轻松获奖. 条款和条件适用*** **PL: Szansa na WYGRANĄ.** Obowiązują warunki korzystania* **CS: Máte šanci VYHRÁT.** Platí všeobecné smluvní podmínky* **SK: Máte šancu VYHRAŤ.** Platia všeobecné zmluvné podmienky* **HU: TE IS NYERHETSZ.** Felhasználási feltételek érvényesek* **RO: Ai putea CÂȘTIGA.** Se aplică termenii și condițiile* **BG: Можете да СПЕЧЕЛИТЕ.** Има определени правила и условия* **LV: Tu vari LAIMĒT.** Ir spēkā noteikumi un nosacījumi.* **ET: Sul on võimalus VÕITA.** Kehtivad tingimused* **LT: Jūs galite LAIMĖTI.** Taikomos sąlygos*

*[LEGO.com/productfeedback-terms](https://www.lego.com/productfeedback-terms)

LEGO and the LEGO logo are trademarks of the LEGO Group. ©2024 The LEGO Group.
© 2024 MARVEL