



76959





 **FR**  
**DONNEZ**  
OU  
**RECYCLEZ**

 OU  OU 

ASSOCIATION    MAGASIN    DÉCHÈTERIE

Adresses sur [quefairedemesdechets.fr](http://quefairedemesdechets.fr)



[LEGO.com/sustainable-packaging](https://LEGO.com/sustainable-packaging)



# BUILDER



Apple and the Apple logo are trademarks of Apple Inc., registered in the U.S. and other countries and regions. App Store is a service mark of Apple Inc.

Google Play and the Google Play logo are trademarks of Google LLC.

Tencent and the Tencent logo are trademarks of Tencent Inc.

Q [LEGO.com/devicecheck](https://www.lego.com/devicecheck)

**EN** Ask parents' permission before going online | **DE** Eltern um Erlaubnis bitten, bevor du online gehst | **FR** Demande l'autorisation d'un parent avant d'aller en ligne | **IT** Chiedi il permesso ai tuoi genitori prima di andare online | **ES** Pídeles permiso a tus papás antes de conectarte a Internet | **PT** Pede autorização aos pais antes de acederes online | **ZH** 上网前应先征得父母的同意 | **PL** Poproś rodziców o zgodę, zanim wejdiesz do Internetu | **CS** Než půjdeš na internet, požádej rodiče o svolení | **SK** Skôr než pôjdeš na internet, vypýtaj si povolenie od rodičov | **HU** Kérj szülői engedélyt, mielőtt online csatlakoznál! | **RO** Cere permisiunea părinților înainte de a te conecta online | **BG** Поискайте разрешение от родител, преди да влезете онлайн | **LV** Pirms došanās tiešsaistē palūdz atļauju vecākiem | **ET** Enne Interneti kasutamist küsi vanematelt luba | **LT** Prieš prisijungdami prie interneto, atsiklauskite tėvų

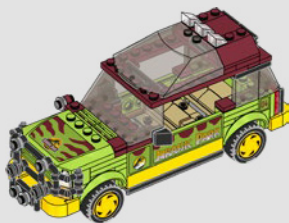
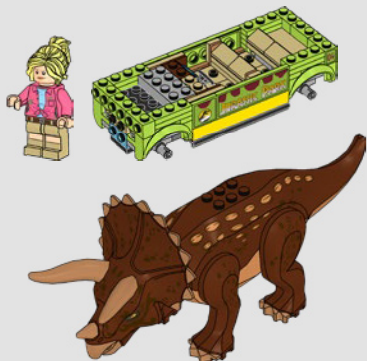



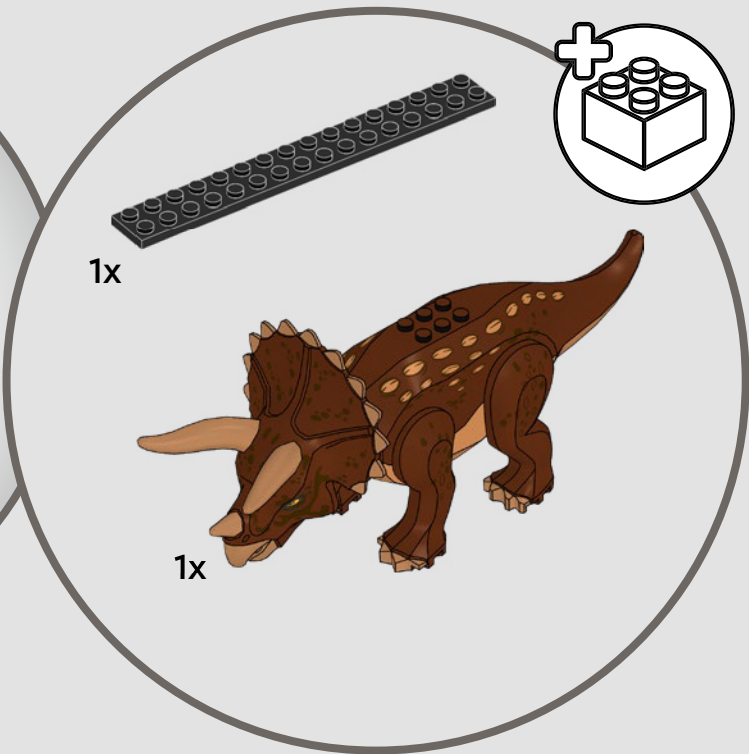

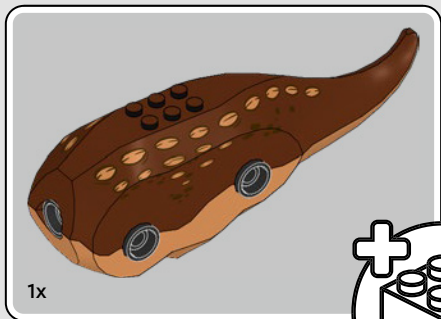
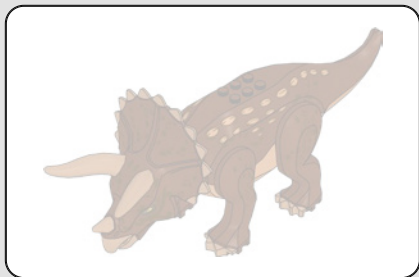

1x

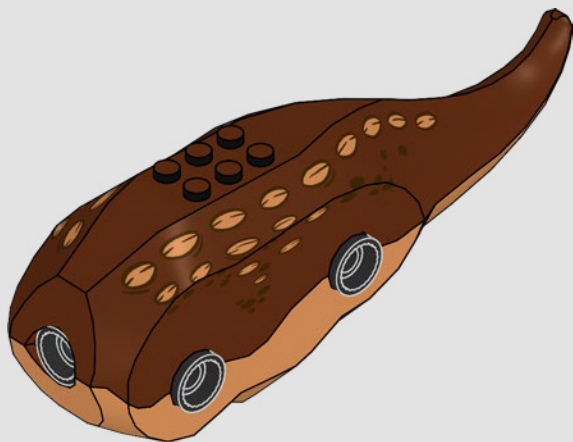
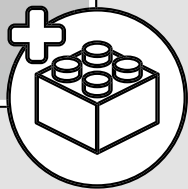

1



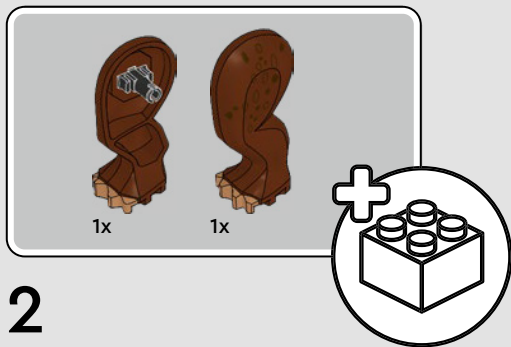

2

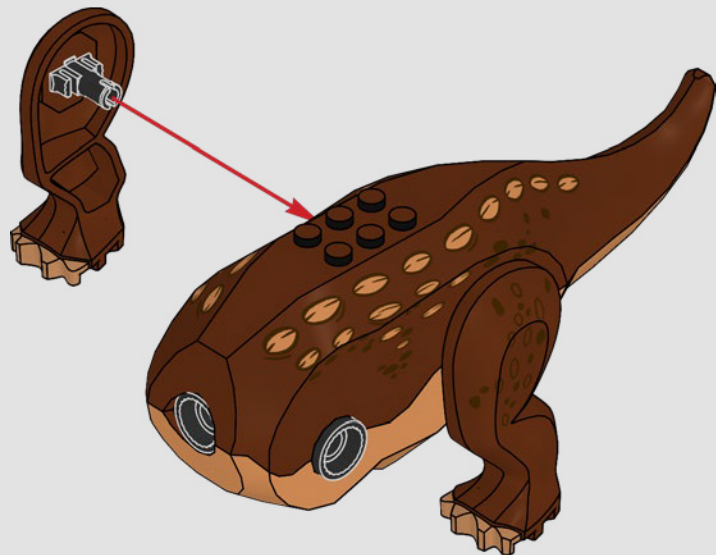

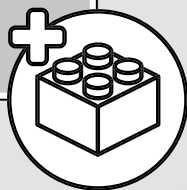

3

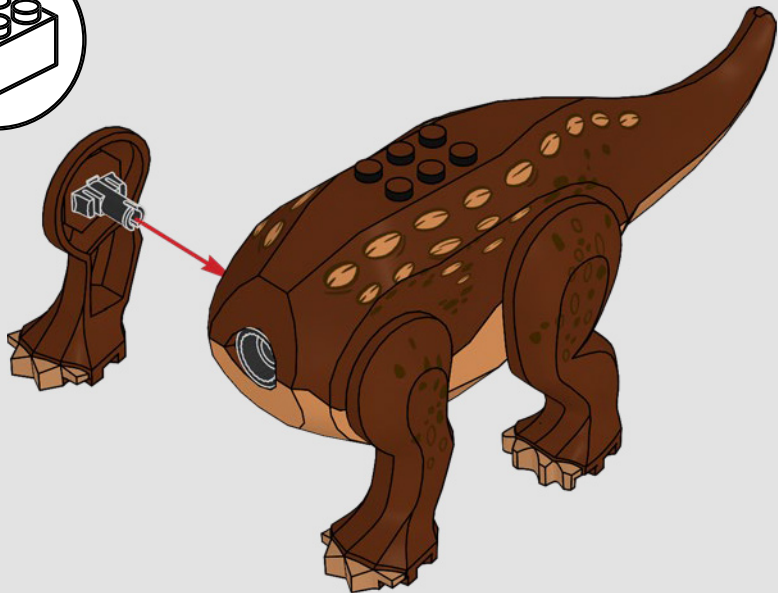

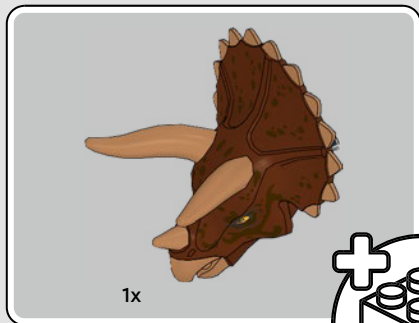

4





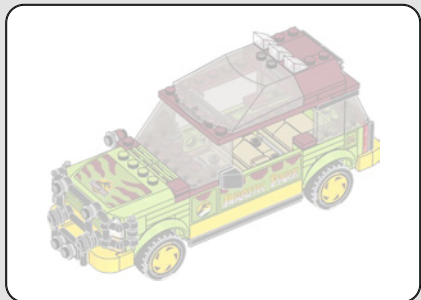
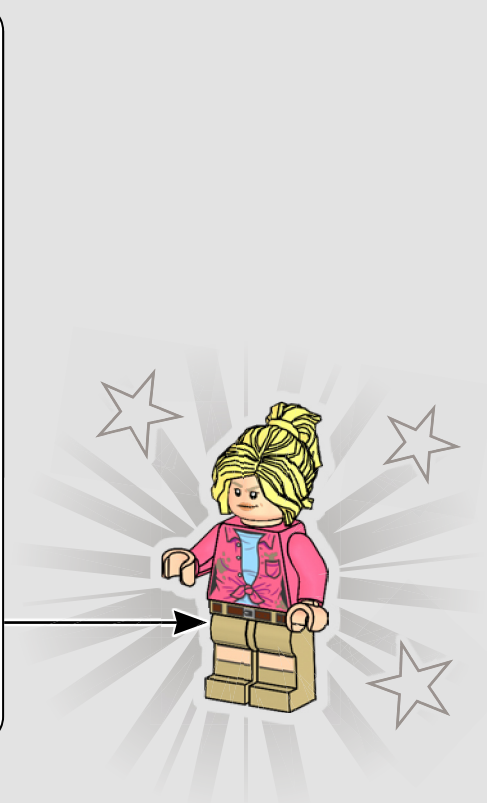
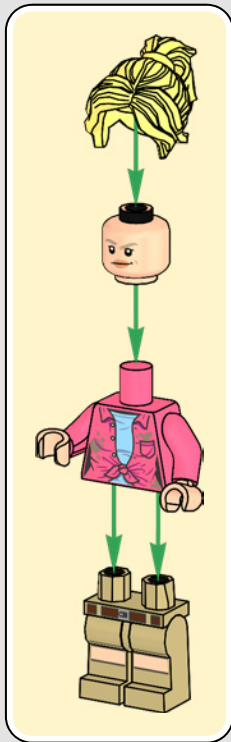

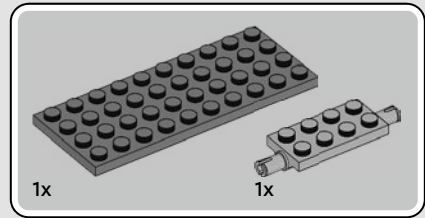
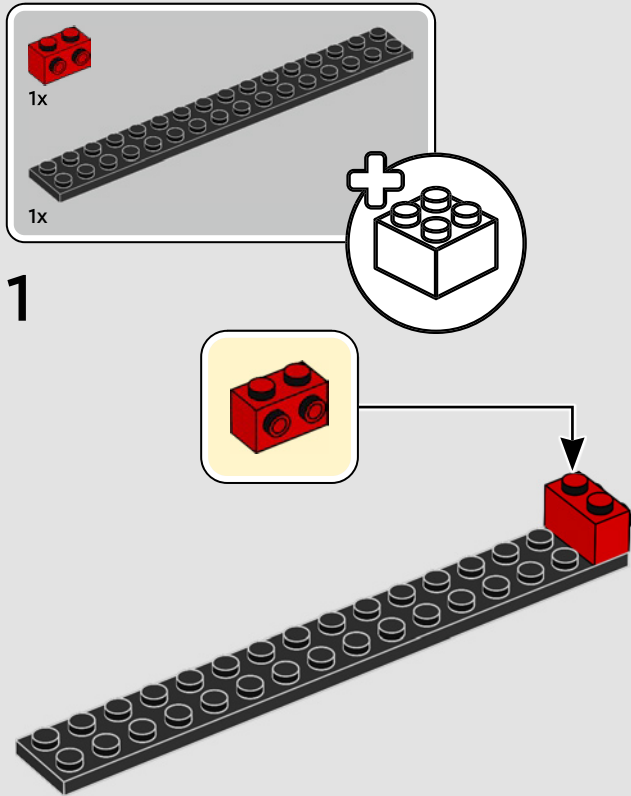

2

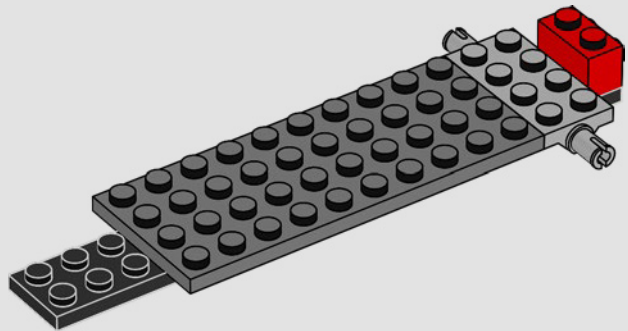

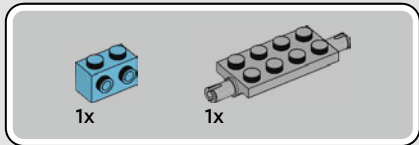

3

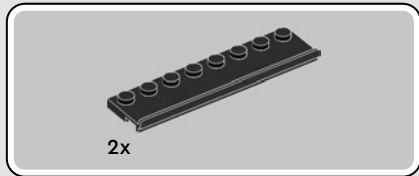
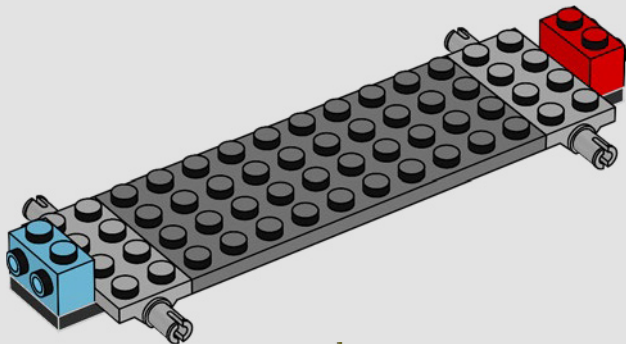

4

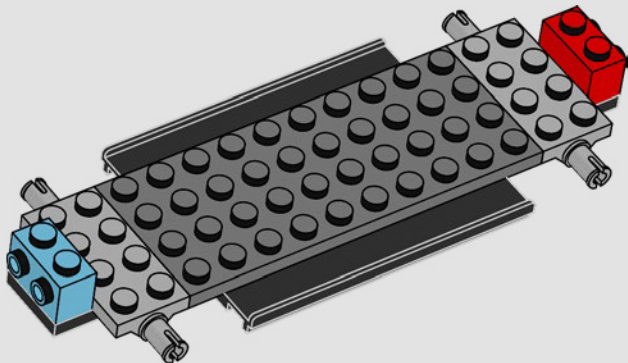



2x

5

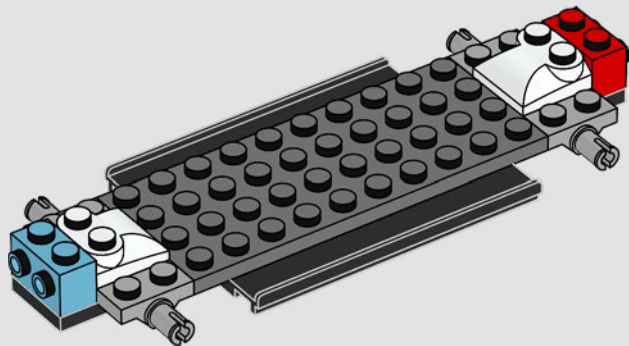

2x

6

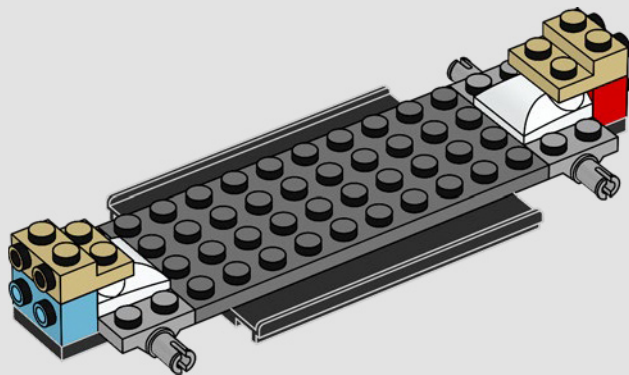

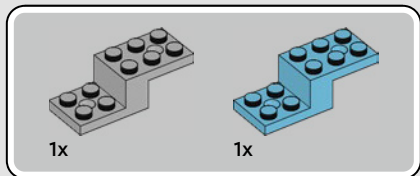

7

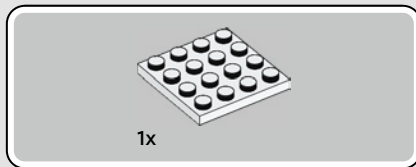
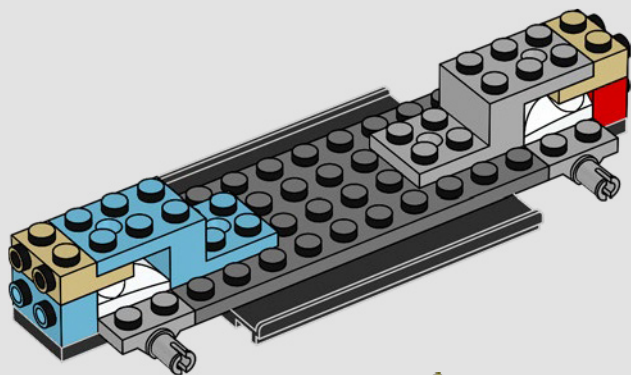

8

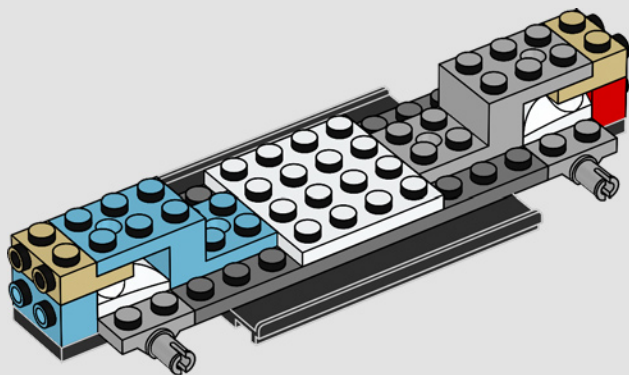



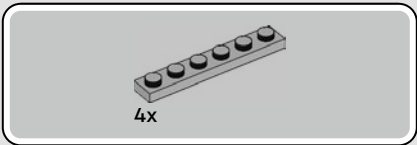

9

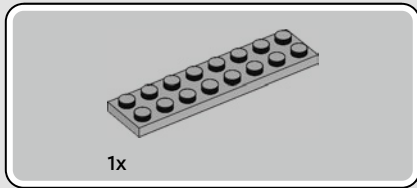
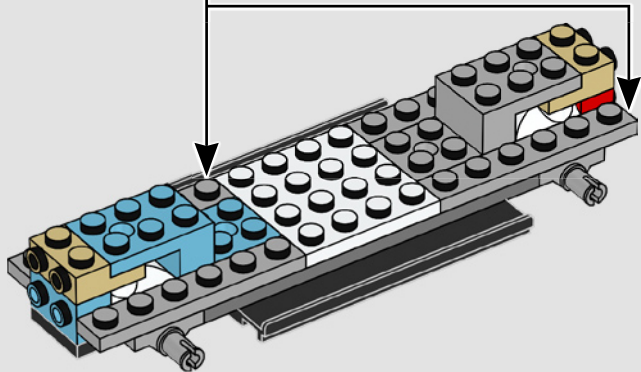
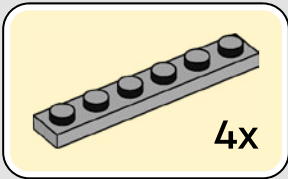

10

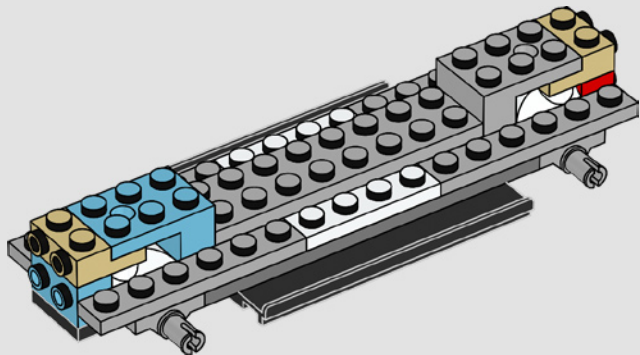

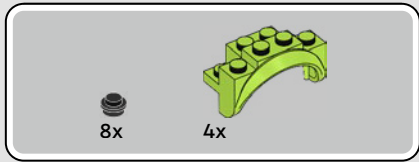

11

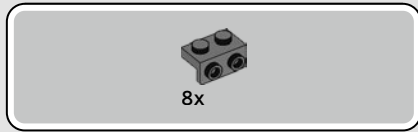
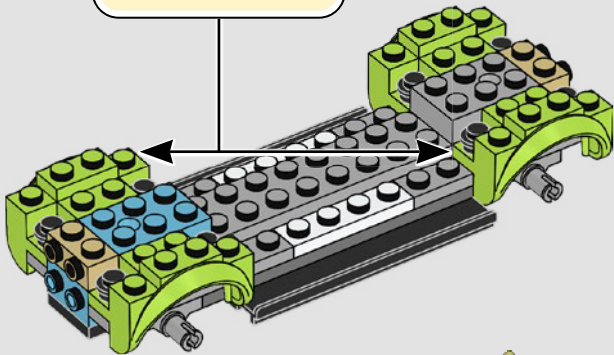
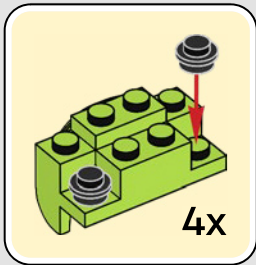

12

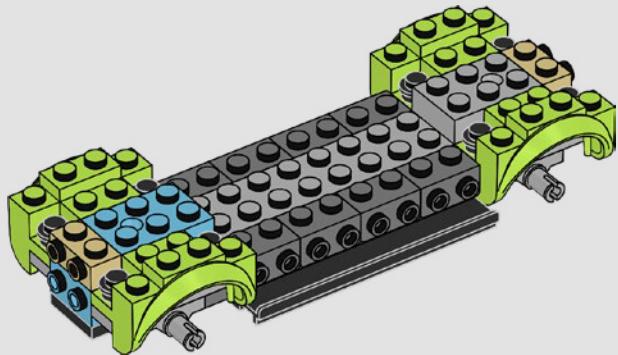

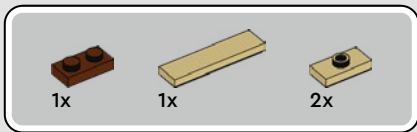

13

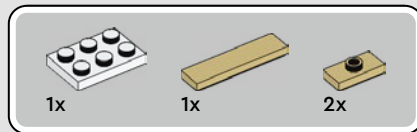
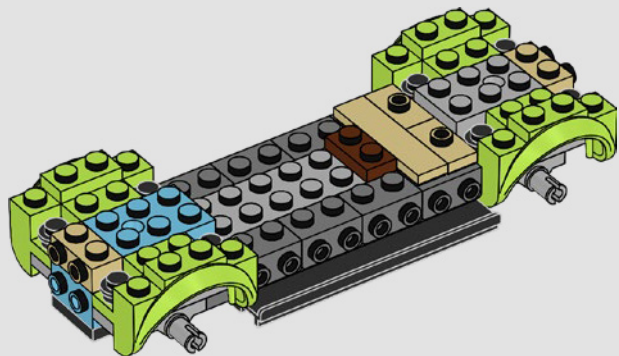

14

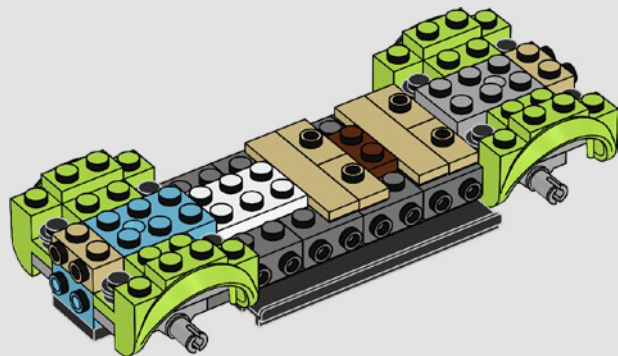



6x

15

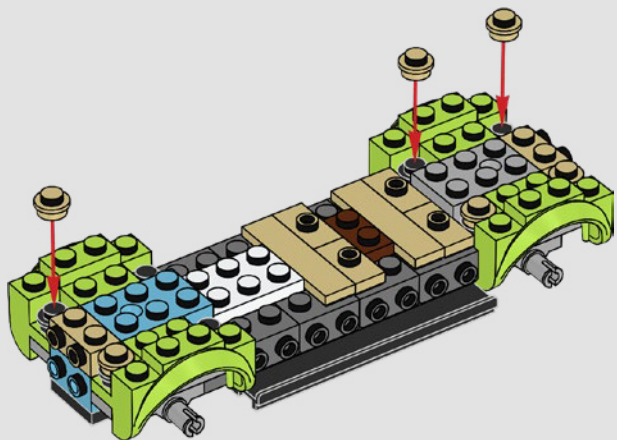

3x

16



3x

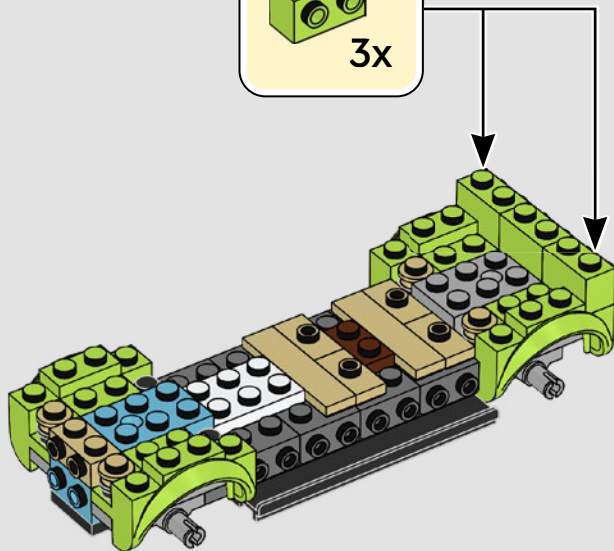

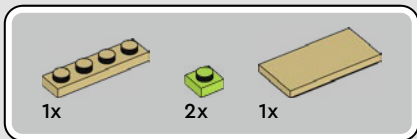

17

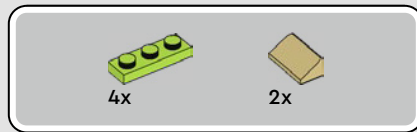
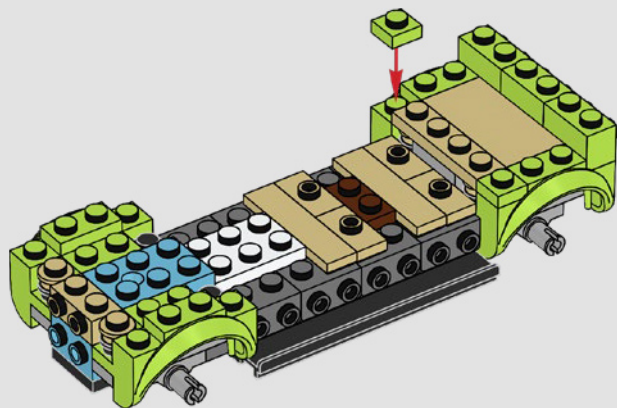

18

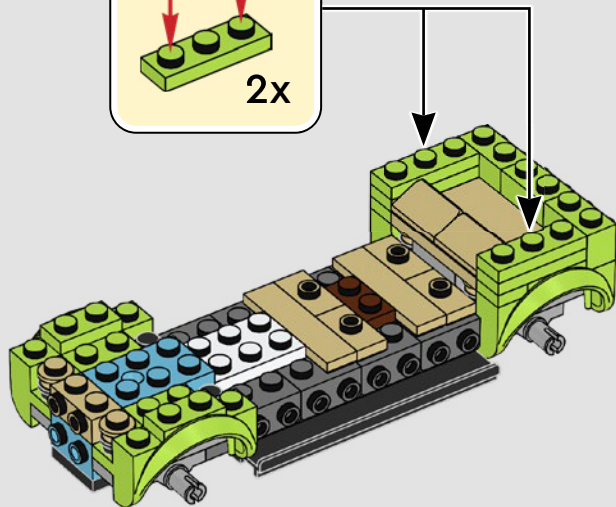
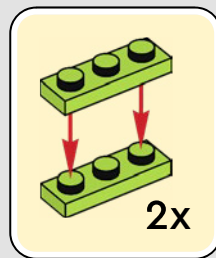





2x



4x

# 19

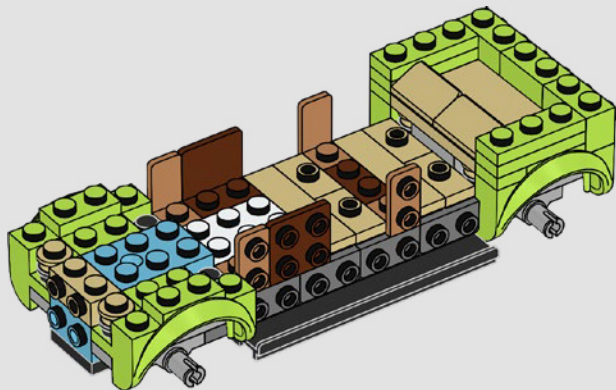

2x



2x

# 20

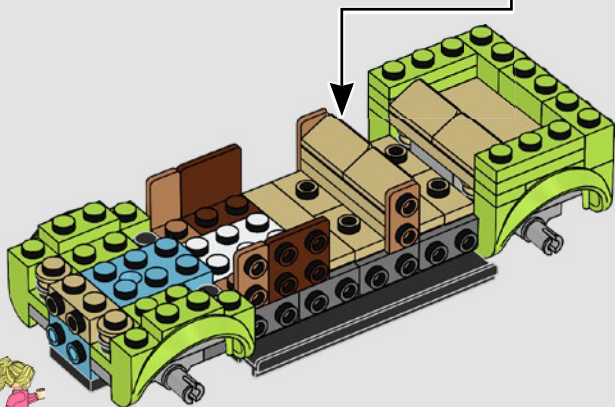
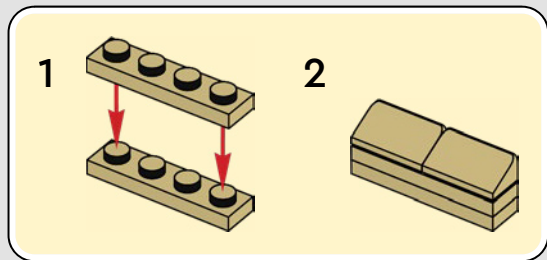



1x



2x

# 21



2x

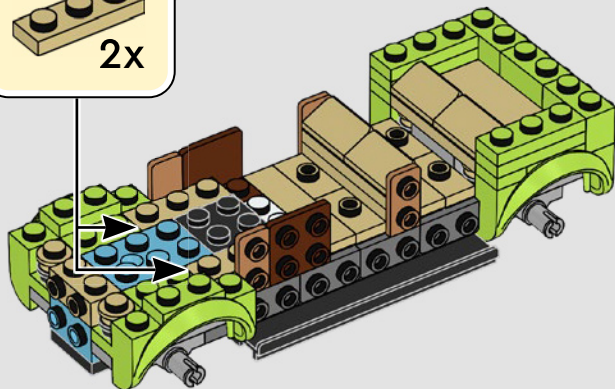

1x



1x

# 22

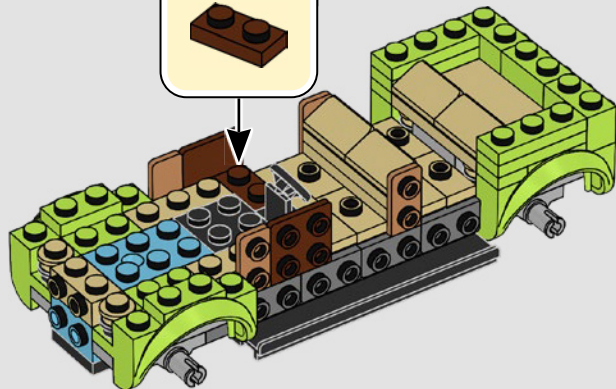

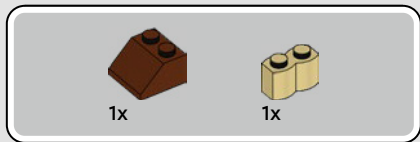

23

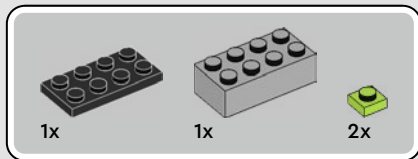
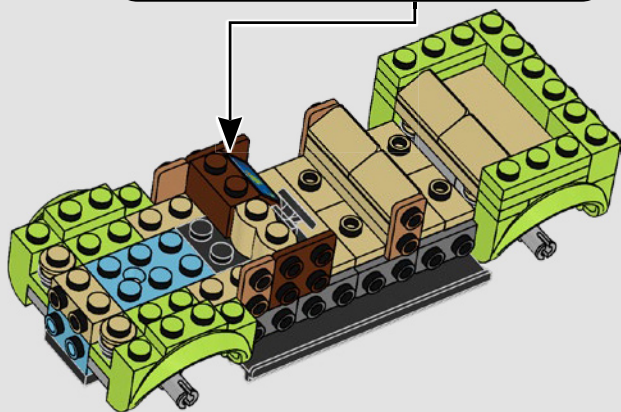
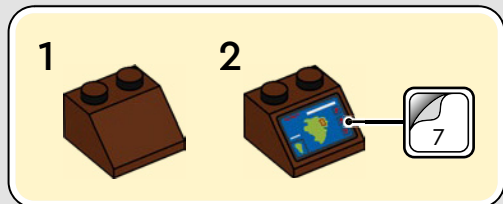

24

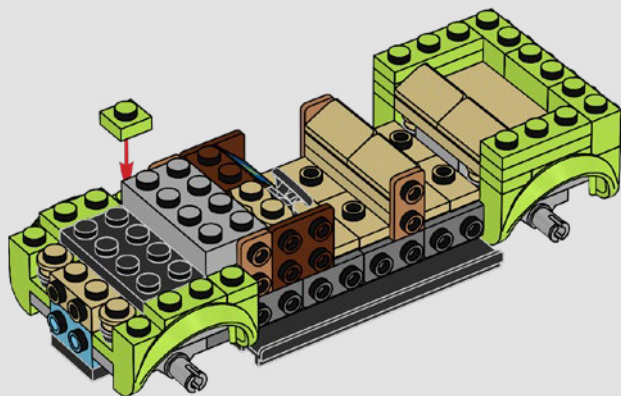



4x

25

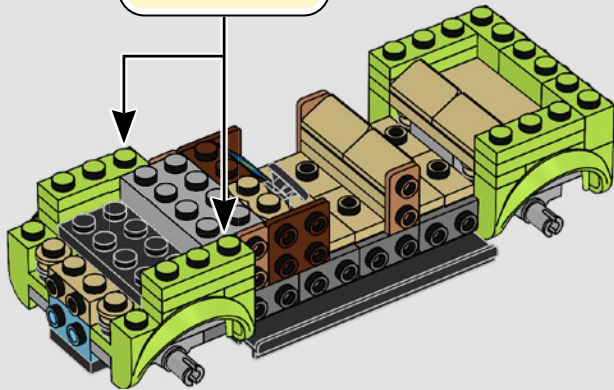
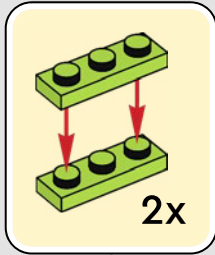

3x

26

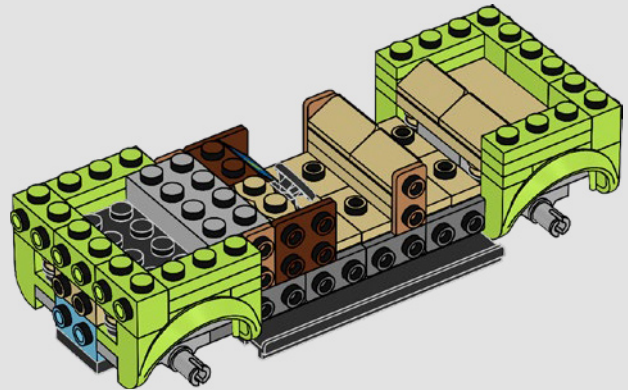

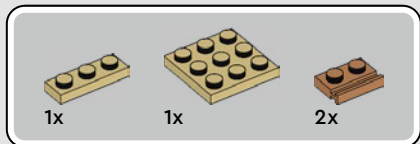

27

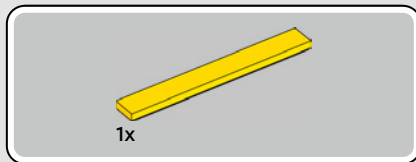
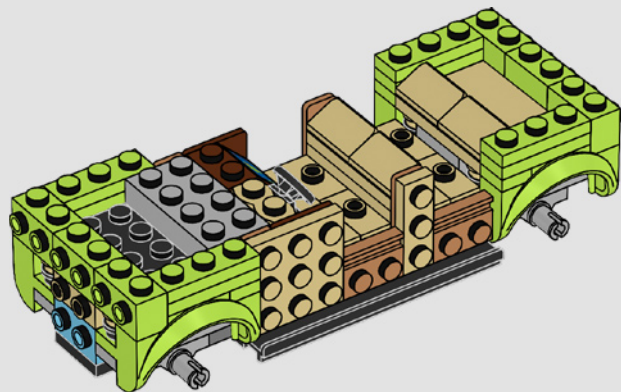

28

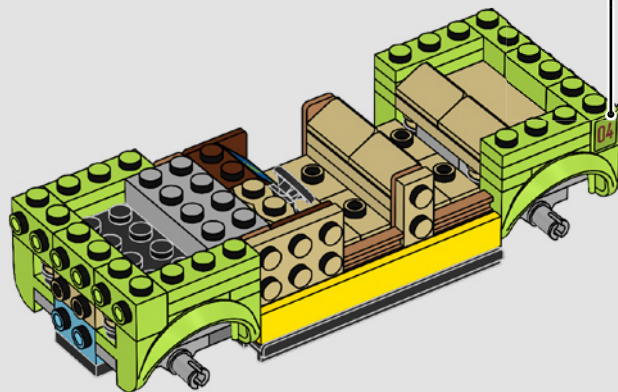



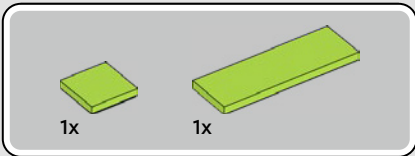

29

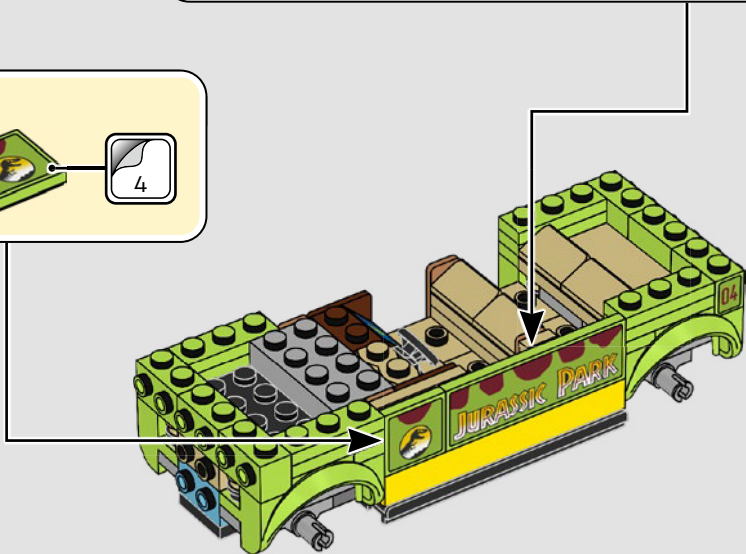
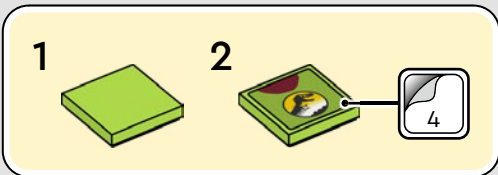
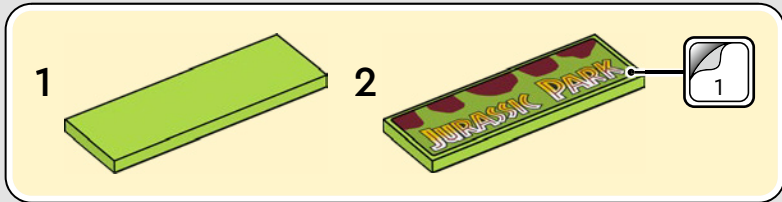

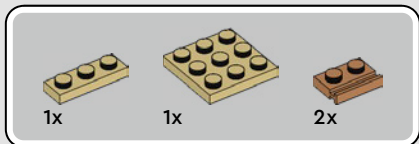

30

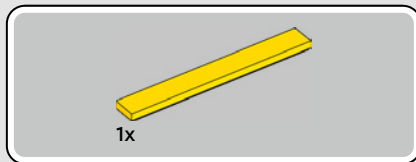
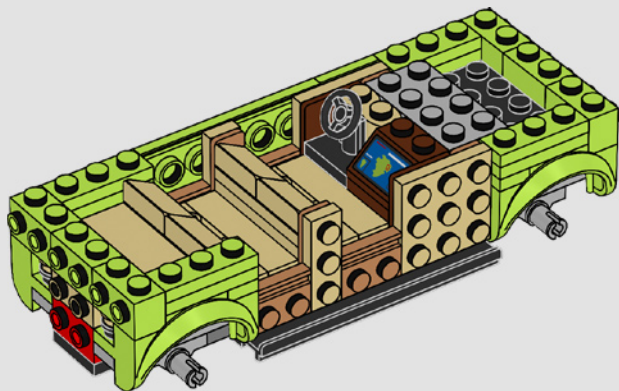

31

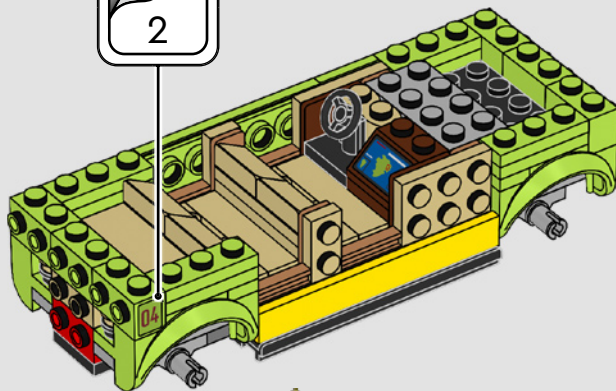

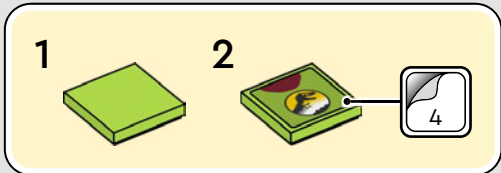
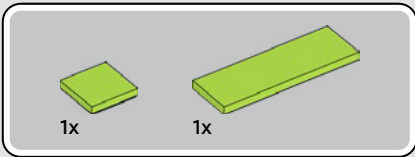

# 32

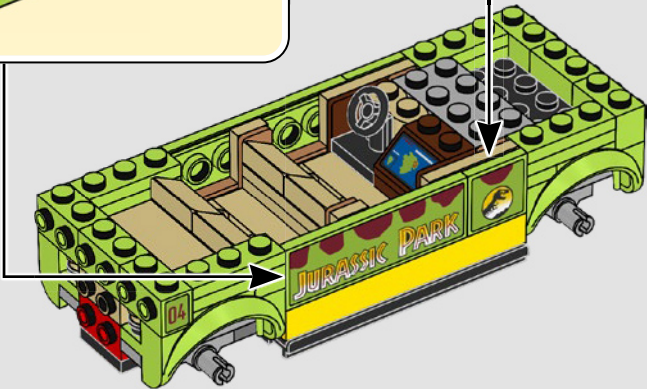
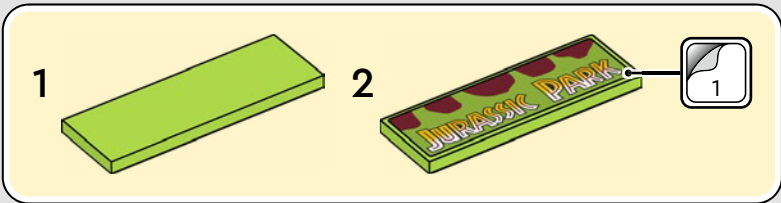

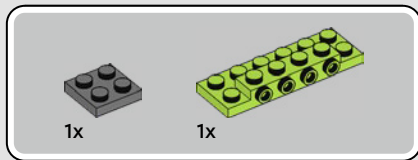
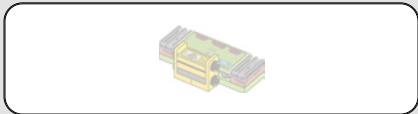

33

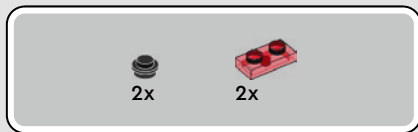
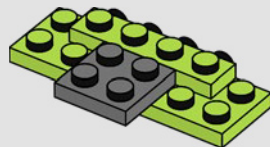

34

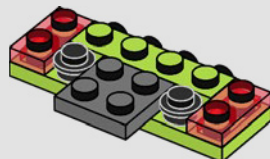

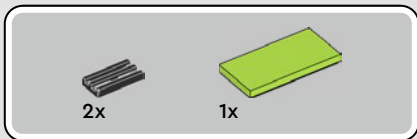

35

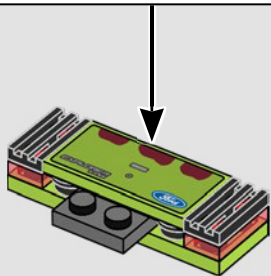
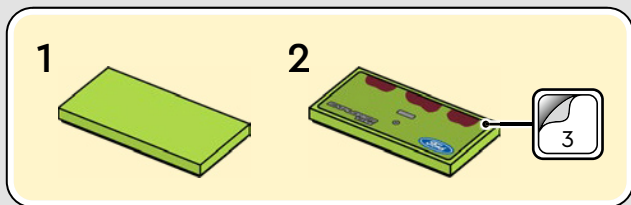

36

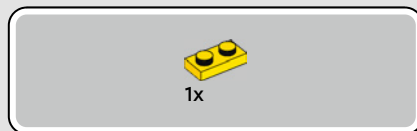
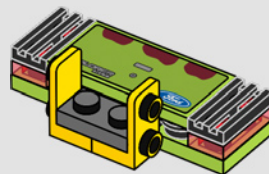

37

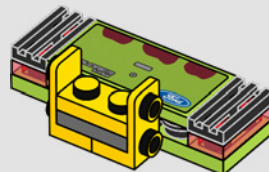



1x

38

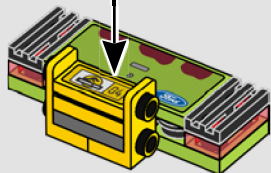
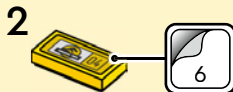
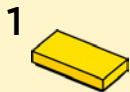

39

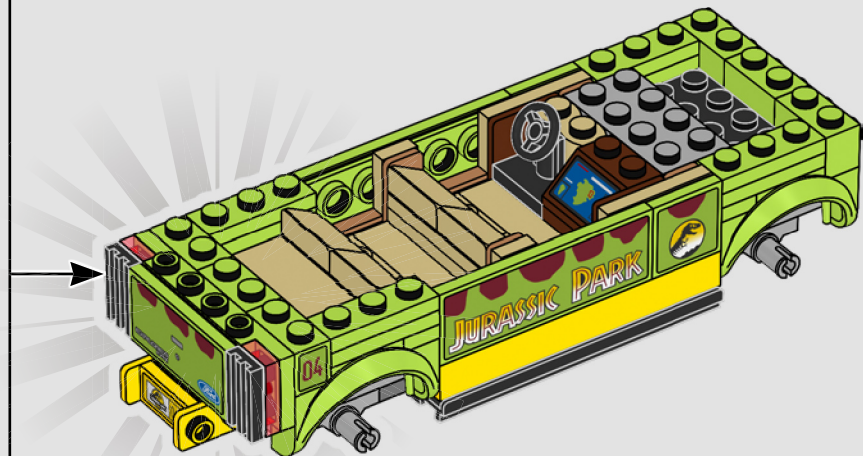

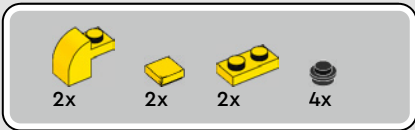

40

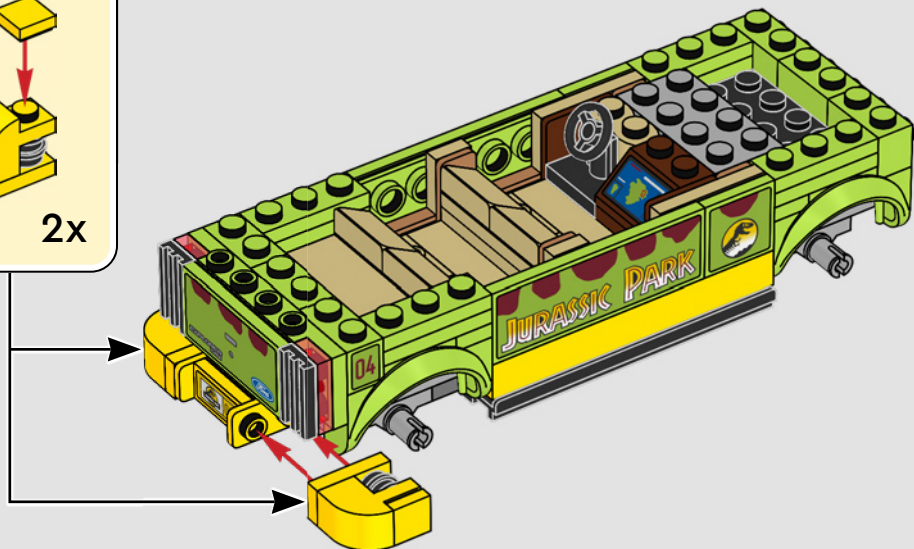
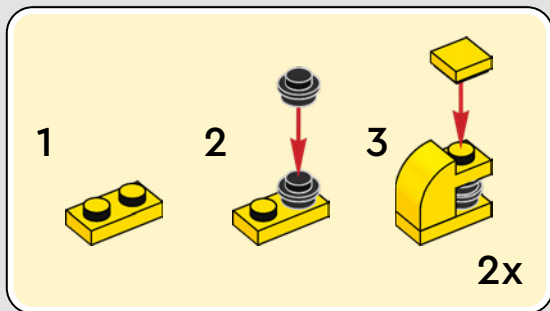



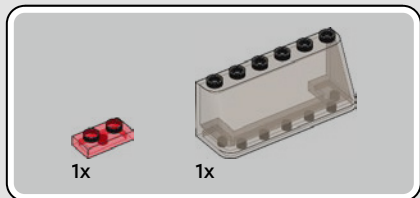

41

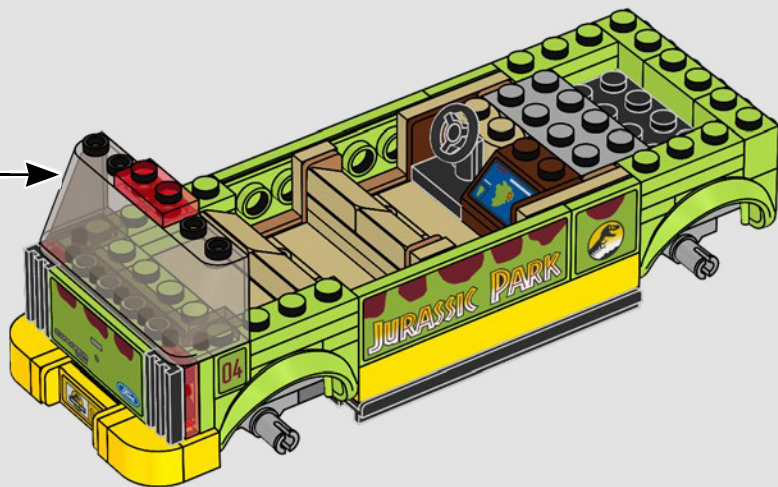
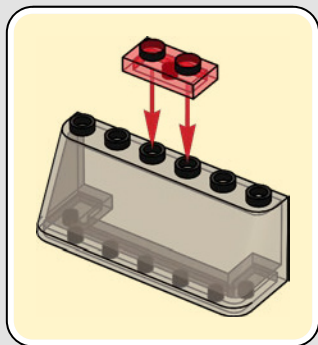

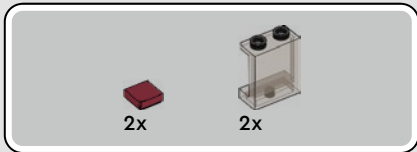

42

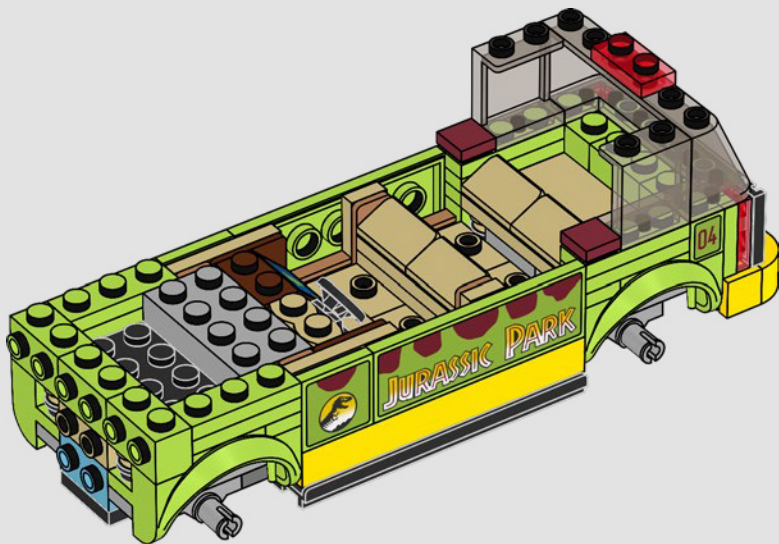



1x



1x

43

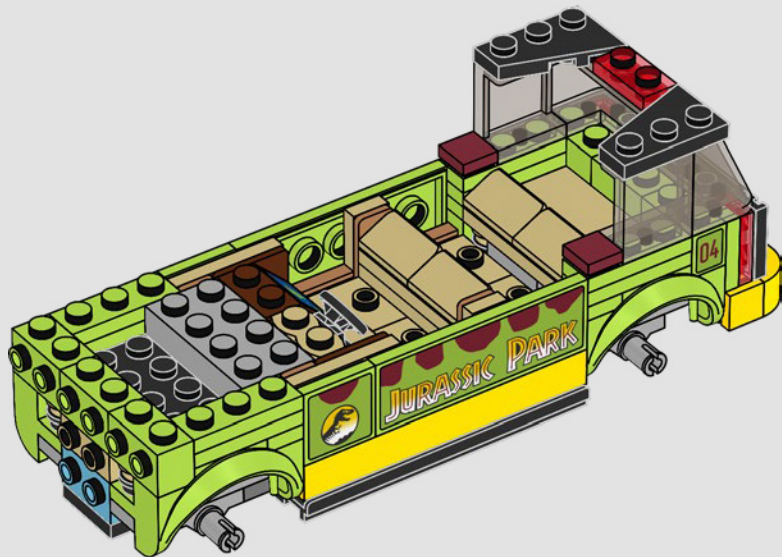

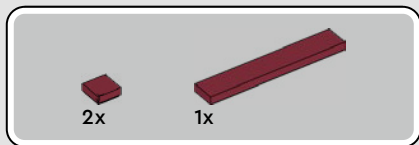

44

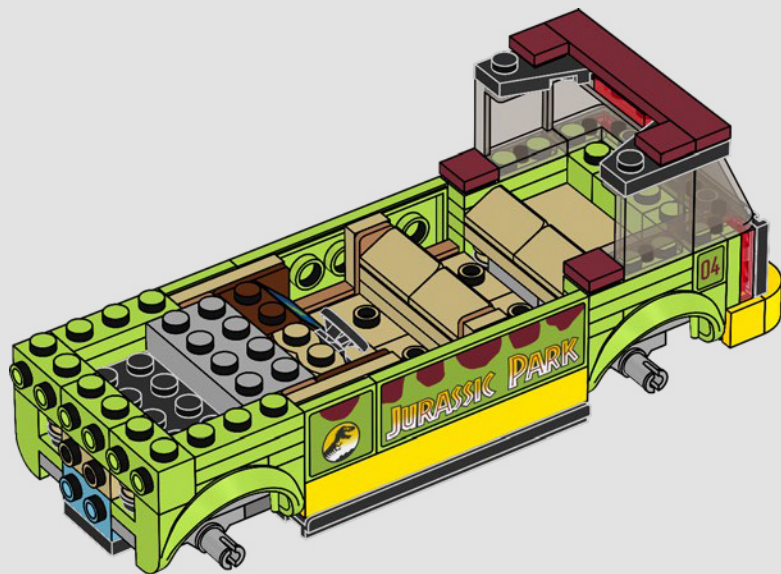

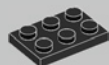

1x

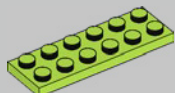

1x

# 45

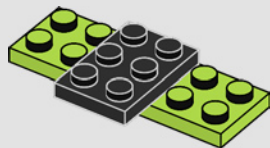

2x



2x



2x

# 46

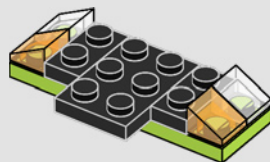

1x



2x

# 47

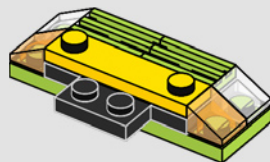



2x

48

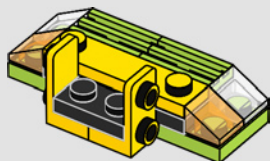

1x



1x

49

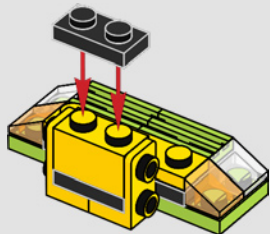

2x

50

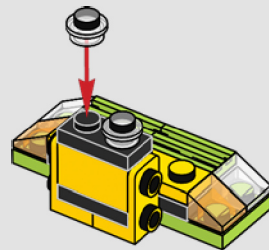

51

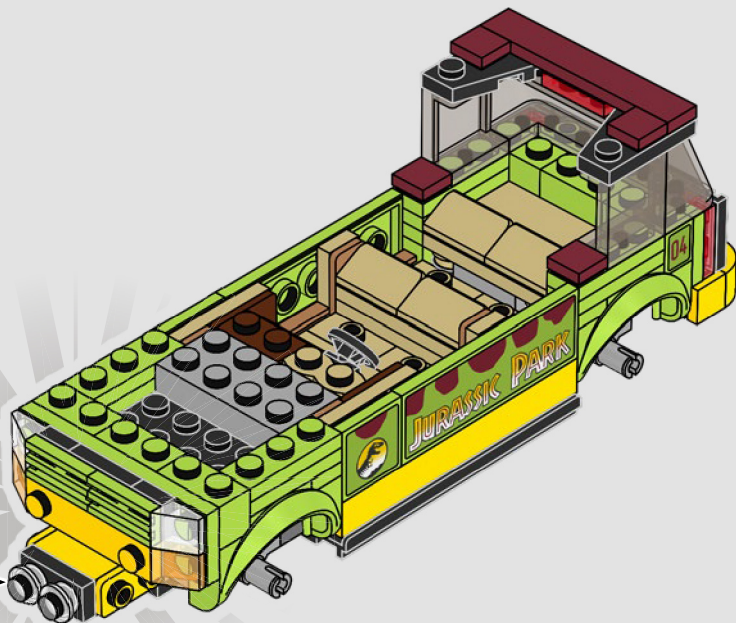





52

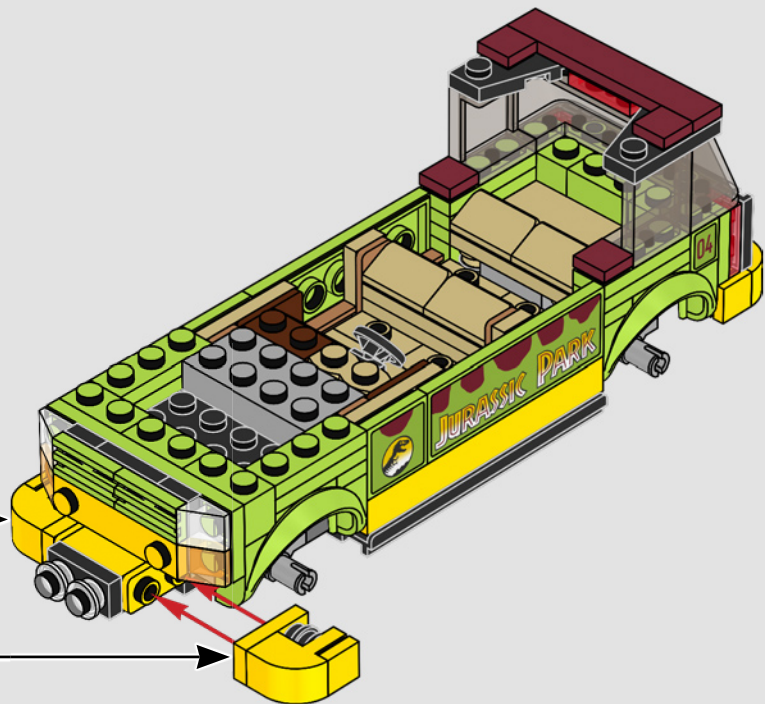
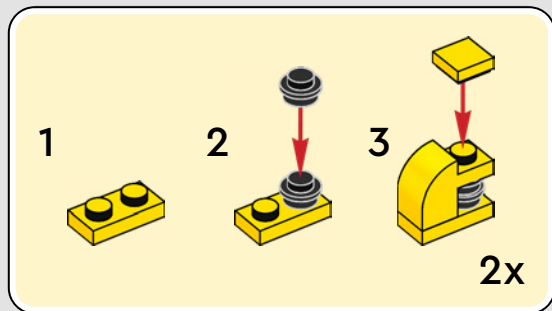



1x

53

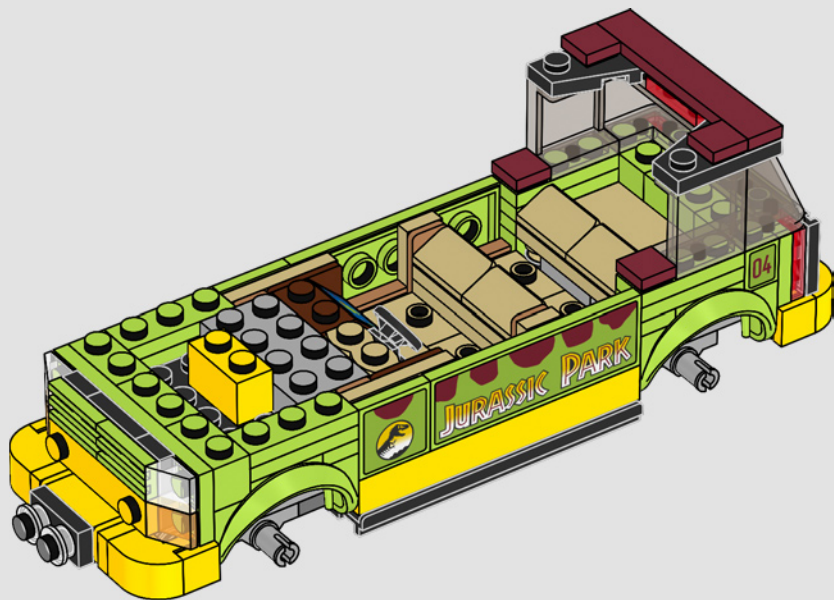

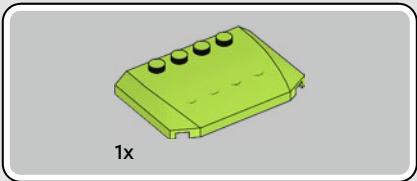

54

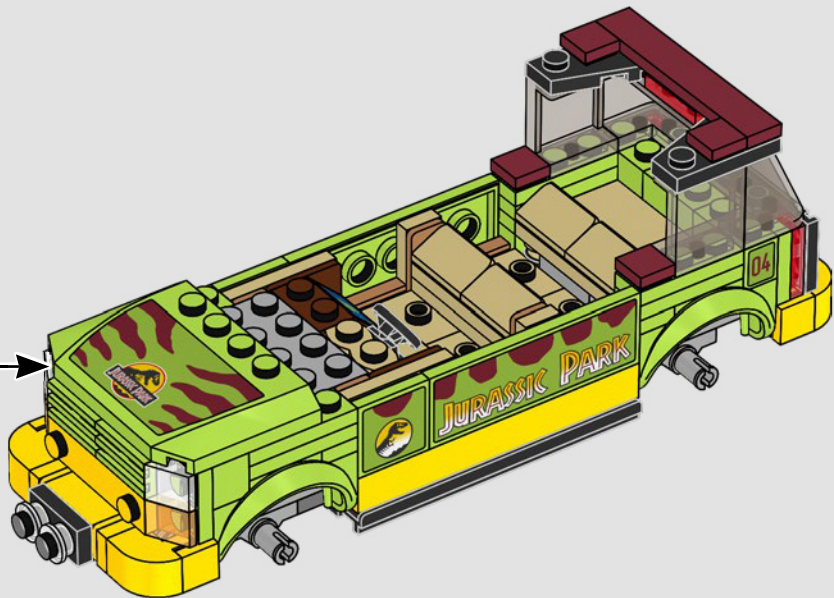
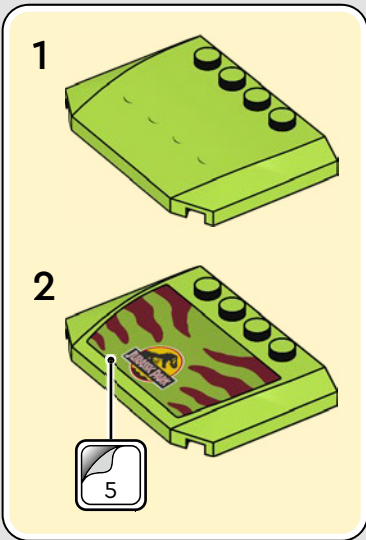

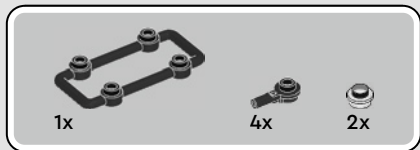

55

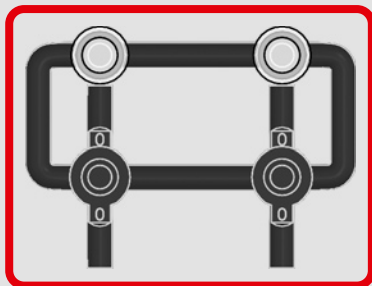

1

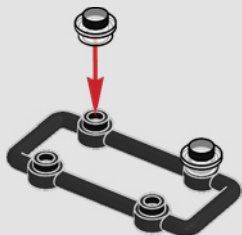

2

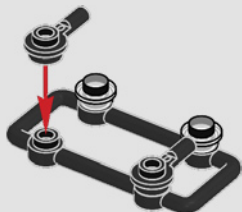

3

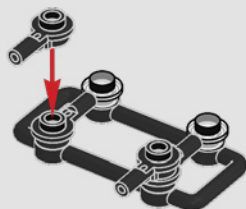

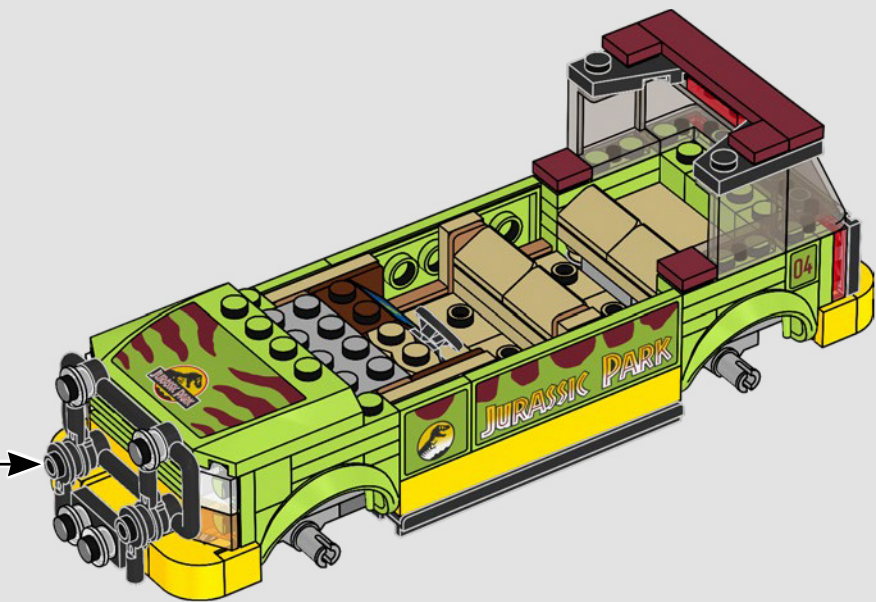



4x



2x

# 56

1



2



2x

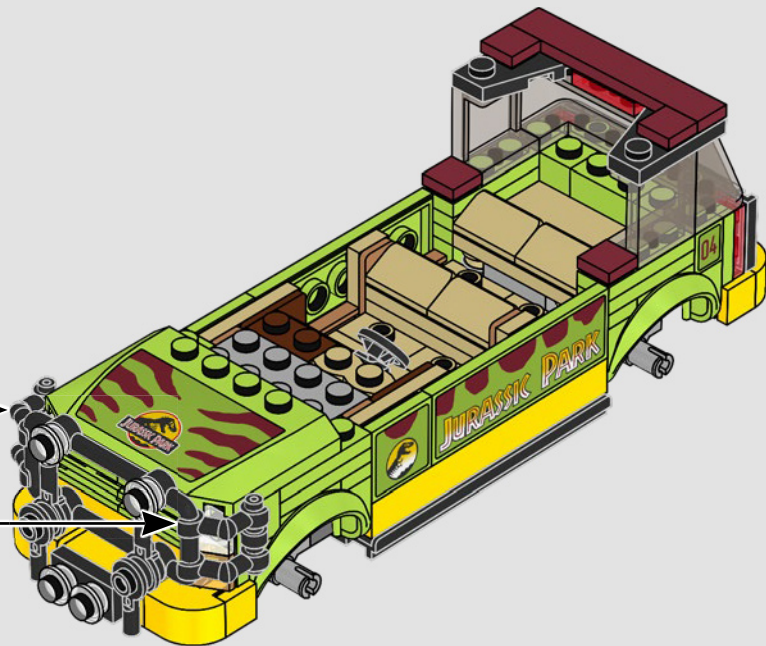

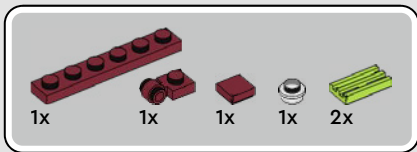

57

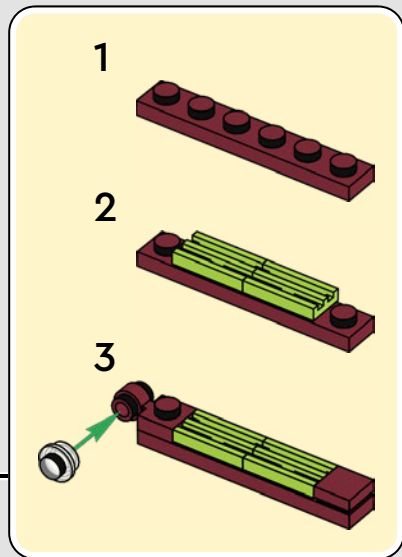
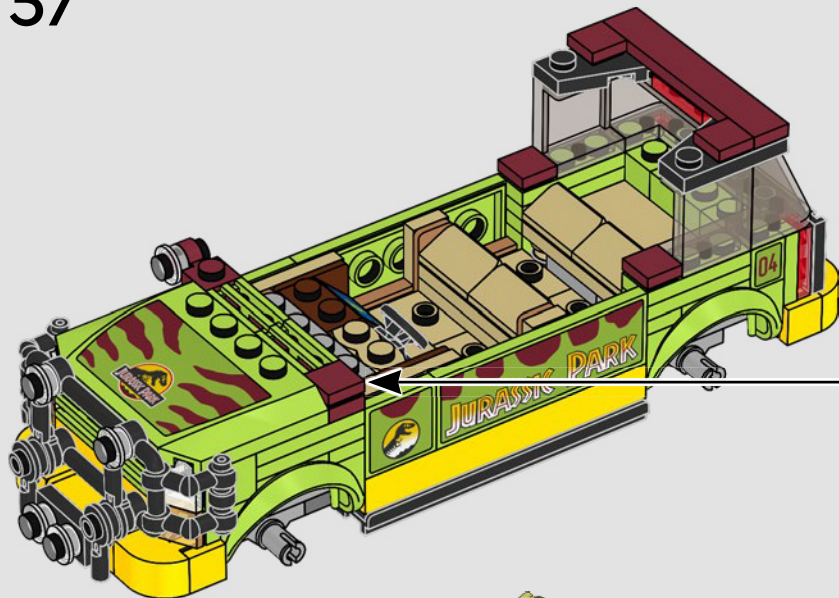



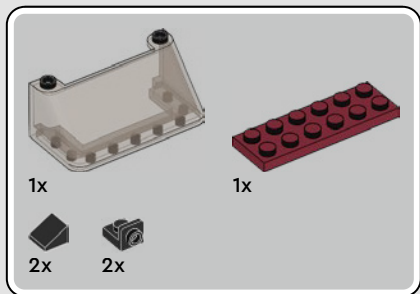

58

1

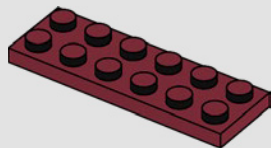

2

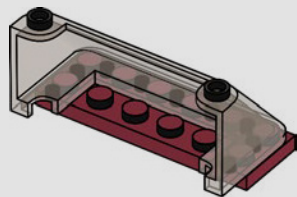

3

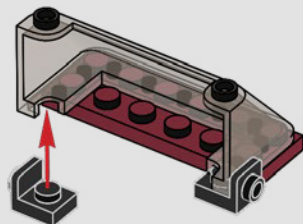

4

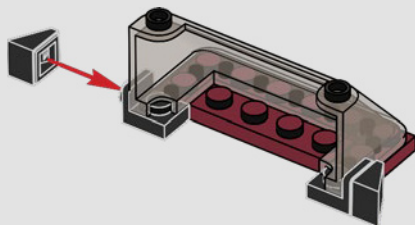

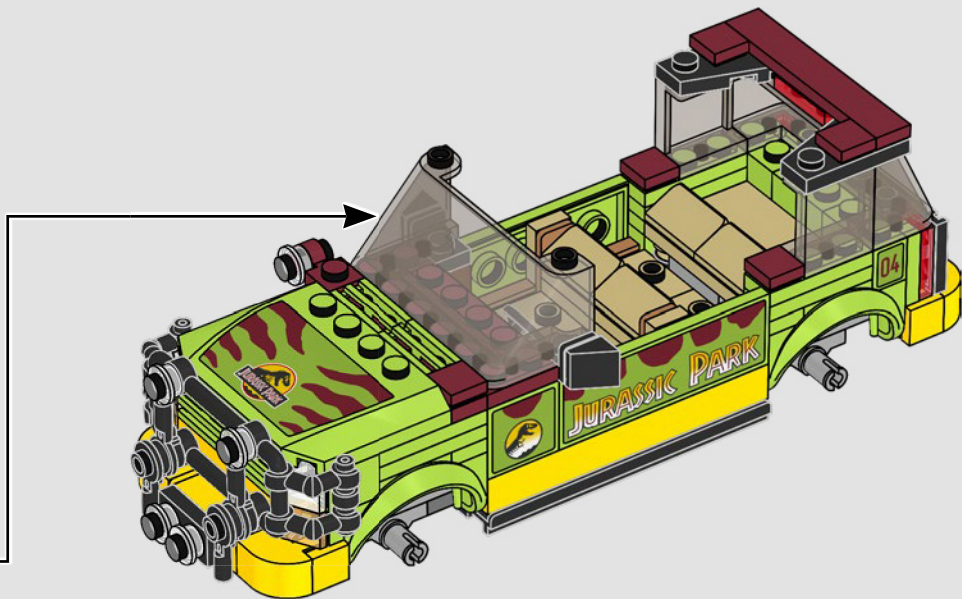

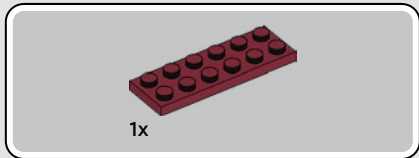
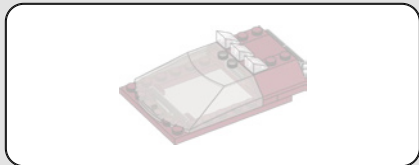

1x

59

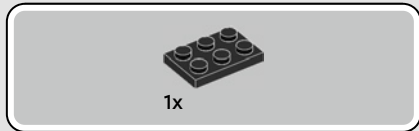
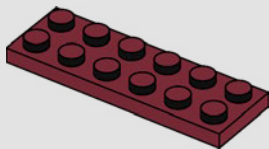

1x

60

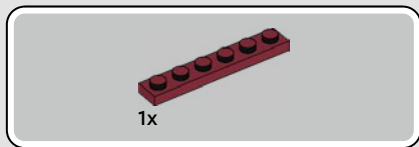
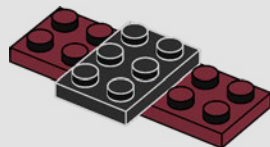

1x

61

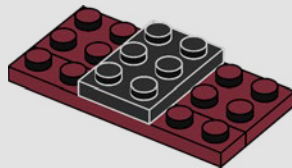

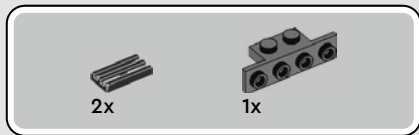

62

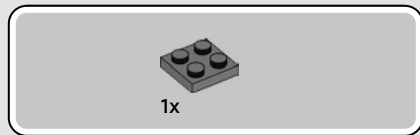
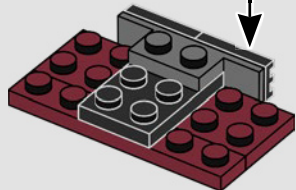
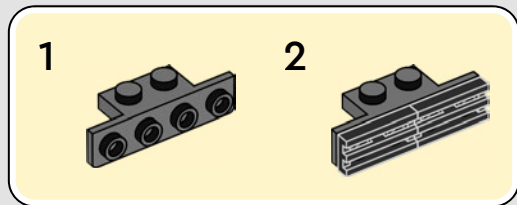

63

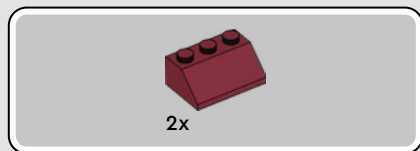
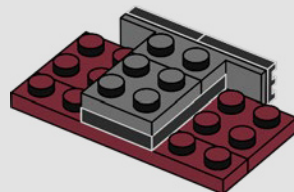

64

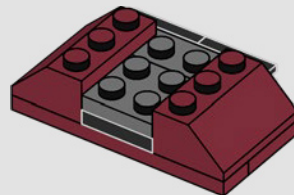

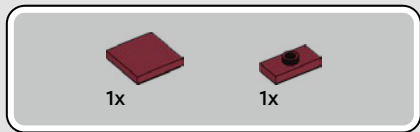

65

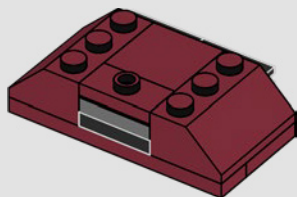

66

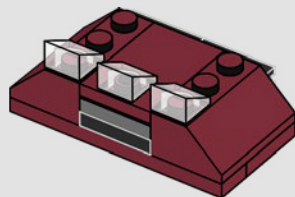

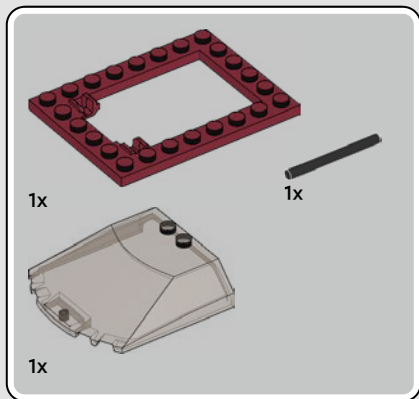

67

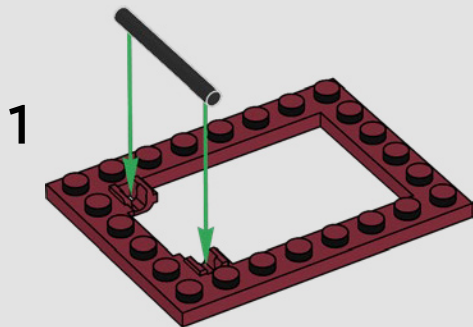

2

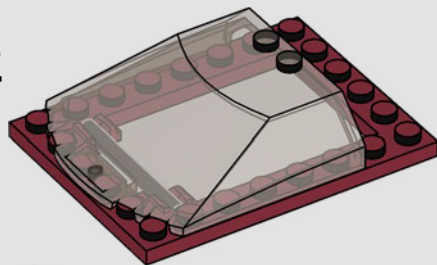

68

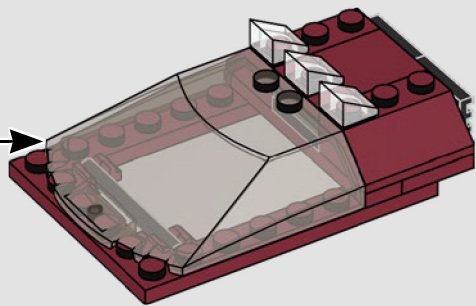

69

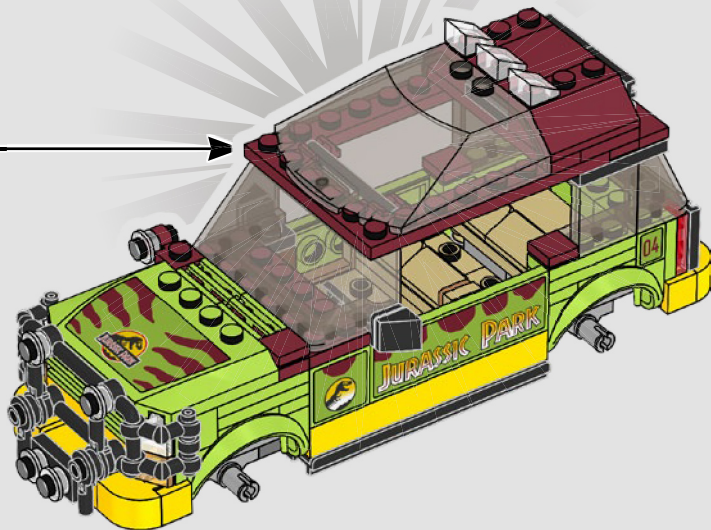



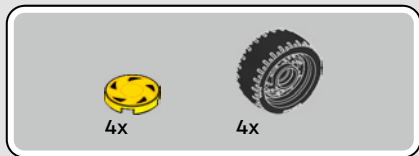

70

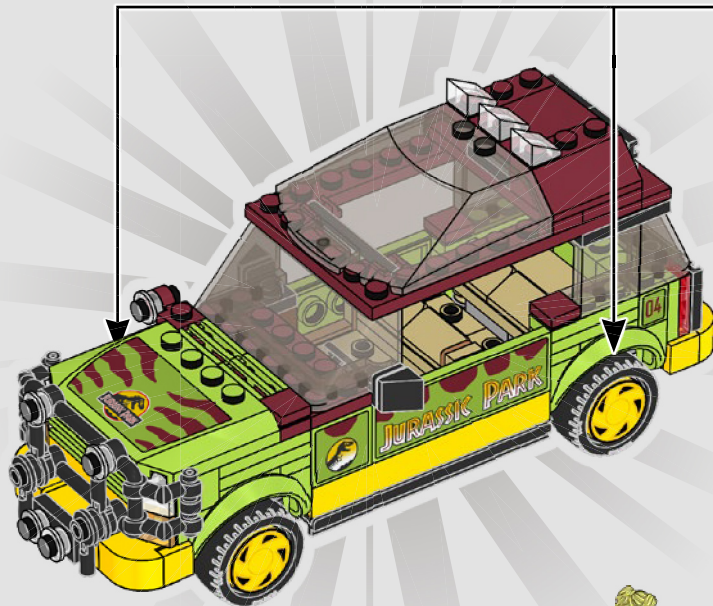

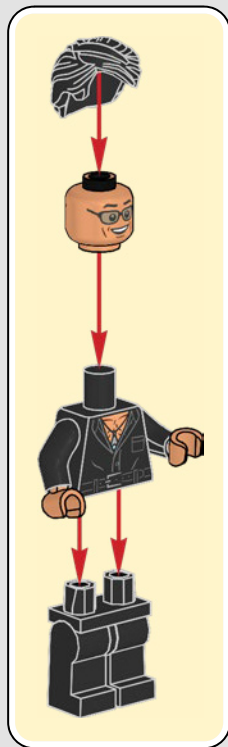

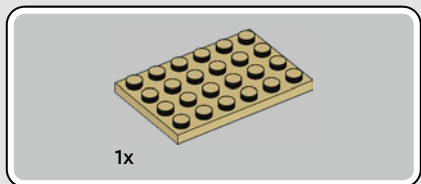
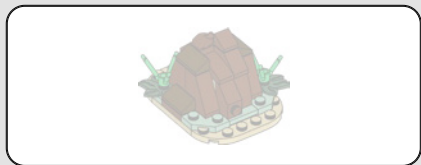

1

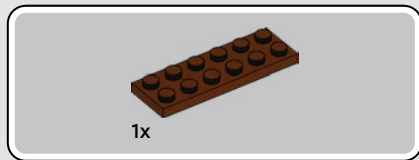
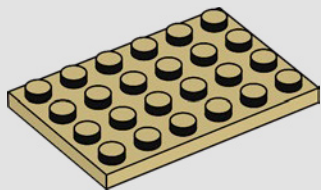

2

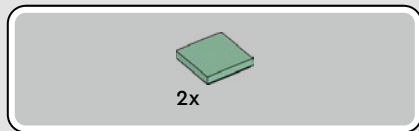
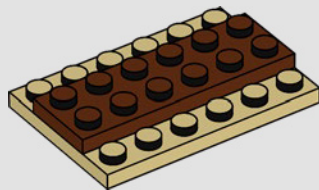

3

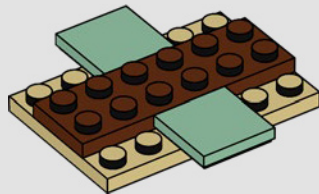



2x

4

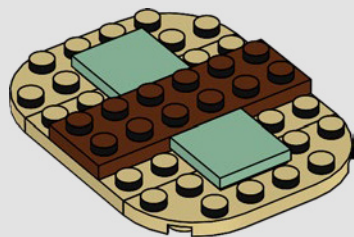

4x

5

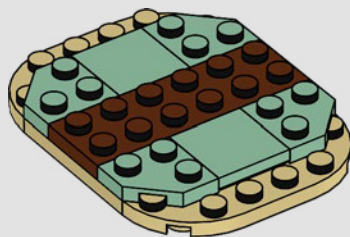



2x

6

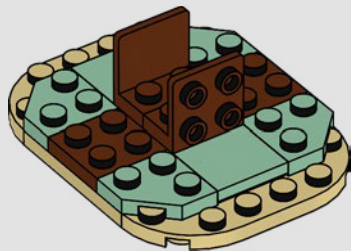

1x

7

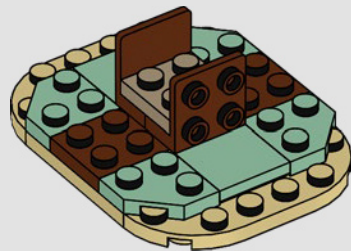

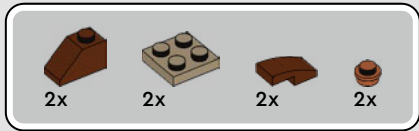

8

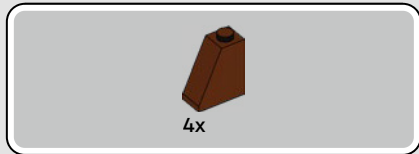
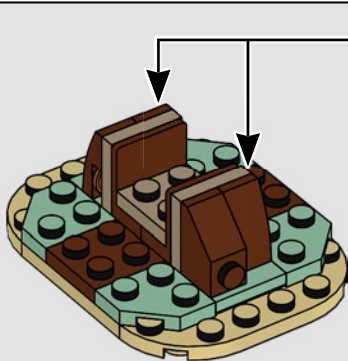
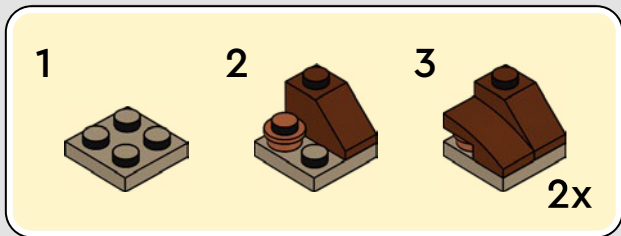

9

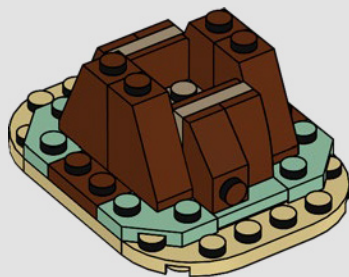



4x

10

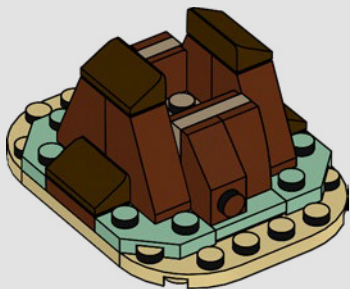

2x

11

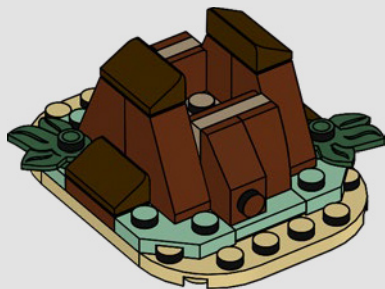



2x

12

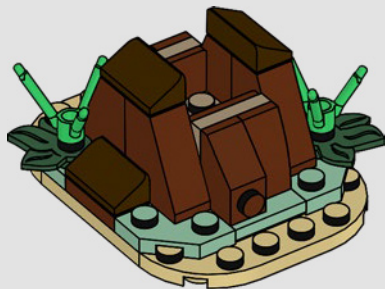

1x

13

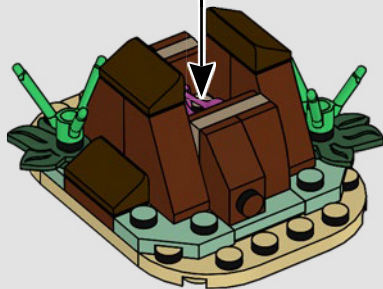



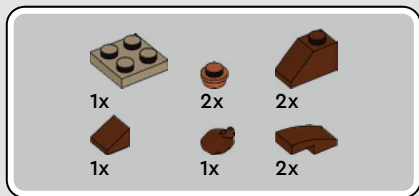

14

1



2



3

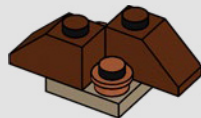

4

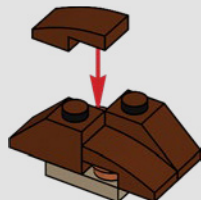

5

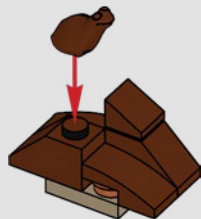



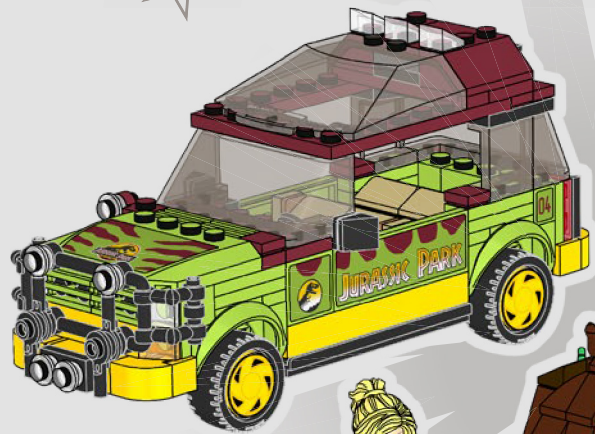



76961









- 1x 6100562
- 4x 6047415
- 2x 6400754
- 2x 6133896
- 4x 6233984
- 2x 6439884
- 5x 4550169
- 1x 6092597
- 1x 4539105
- 1x 4650865
- 2x 4539062
- 2x 4618986
- 1x 6282000
- 1x 6389824
- 2x 6245265
- 1x 4504376
- 4x 4211199
- 4x 4629736
- 1x 4211202
- 4x 6069984
- 2x 4211150
- 1x 4211247
- 4x 6226436
- 1x 6436311
- 1x 6436310
- 1x 6436313
- 1x 6436308
- 1x 6442974
- 1x 6436312
- 1x 6234347
- 1x 4211385
- 1x 6028811
- 4x 4211438
- 1x 4211406
- 2x 4211094
- 1x 4211122
- 8x 6214341
- 1x 6271127
- 1x 4211006
- 1x 6390255
- 1x 6226739
- 4x 6127366
- 4x 6380634
- 4x 6433739
- 1x 6348142
- 1x 6355732
- 1x 6441067

 [LEGO.com/service](https://www.LEGO.com/service)



YOU COULD  
**WIN**

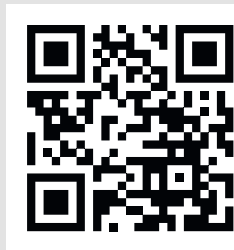

Scan this QR code or go to  
**LEGO.COM/PRODUCTFEEDBACK** and give  
us your short feedback about this LEGO® set  
for a chance to win a cool LEGO prize.

Terms and Conditions apply\*

**EN: YOU COULD WIN.** Terms and Conditions apply\* **DE: Du könntest GEWINNEN.** Es gelten die Teilnahmebedingungen\* **FR: Tu pourrais GAGNER.** Des conditions s'appliquent\* **IT: Potresti VINCERE tu.** Termini e condizioni sono applicabili\* **ES: Puedes GANAR.** Aplican términos y condiciones\* **PT: Poderá GANHAR.** Aplicam-se termos e condições\* **ZH: 轻松获奖. 条款和条件适用\*** **PL: Szansa na WYGRANĄ.** Obowiązują warunki korzystania\* **CS: Máte šanci VYHRÁT.** Platí všeobecné smluvní podmínky\* **SK: Máte šancu VYHRÁŤ.** Platia všeobecné zmluvné podmienky\* **HU: TE IS NYERHETSZ.** Felhasználási feltételek érvényesek\* **RO: Ai putea CÂȘTIGA.** Se aplică termenii și condiții\* **BG: Можете да СПЕЧЕЛИТЕ.** Има определени правила и условия\* **LV: Tu vari LAIMĒT.** Ir spēkā noteikumi un nosacījumi.\* **ET: Sul on võimalus VÕITA.** Kehtivad tingimused\* **LT: Jūs galite LAIMĖTI.** Taikomos sąlygos\*

\*[LEGO.com/productfeedback-terms](https://www.lego.com/productfeedback-terms)

LEGO and the LEGO logo and are trademarks of the LEGO Group. ©2023 The LEGO Group.  
© Universal City Studios LLC and Amblin Entertainment, Inc. All Rights Reserved.  
Ford Motor Company Trademarks and Trade Dress used under license to the LEGO Group.

6499541