



MARVEL

76257





LEGO.com/sustainable-packaging

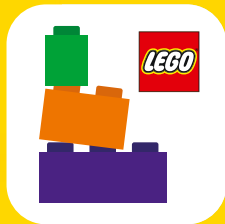

BUILDER



Apple and the Apple logo are trademarks of Apple Inc., registered in the U.S. and other countries and regions. App Store is a service mark of Apple Inc. Google Play and the Google Play logo are trademarks of Google LLC. Tencent and the Tencent logo are trademarks of Tencent Inc.

Q [LEGO.com/devicecheck](https://www.lego.com/devicecheck)

EN Ask parents' permission before going online | **DE** Eltern um Erlaubnis bitten, bevor du online gehst | **FR** Demande l'autorisation d'un parent avant d'aller en ligne | **IT** Chiedi il permesso ai tuoi genitori prima di andare online | **ES** Pídeles permiso a tus papás antes de conectarte a Internet | **PT** Pede autorização aos pais antes de acederes online | **JA** オンラインになる前に ほご者の方のきよかをもらおう | **ZH** 上网前应先征得父母的同意 | **KO** 온라인 접속 전에 보호자 동의가 필요합니다 | **RU** Спроси разрешения у родителей, прежде чем заходить в интернет | **PL** Poproś rodziców o zgodę, zanim wejdziesz do Internetu | **CS** Než půjdeš na internet, požádej rodiče o svolení | **SK** Skôr než pôjdeš na internet, vypýtaj si povolenie od rodičov | **HU** Kérj szülői engedélyt, mielőtt online csatlakoznál! | **RO** Cere permisiunea părinților înainte de a te conecta online | **BG** Поискайте разрешение от родител, преди да влезете онлайн | **LV** Pirms došanās tiešsaistē palūdz atļauju vecākiem | **ET** Enne Interneti kasutamist küsi vanematelt luba | **LT** Prieš prisijungdami prie interneto, atsiklauskite tėvų

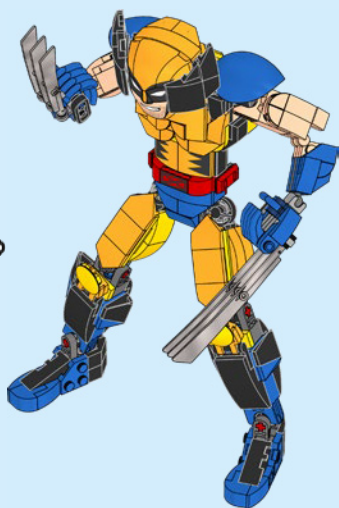
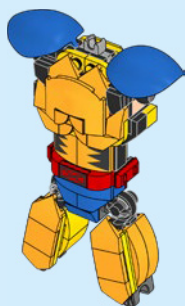

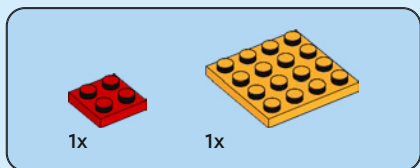

1

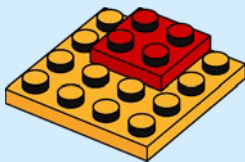



1x



1x

2

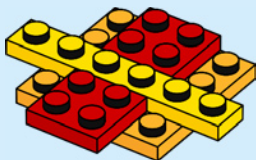

2x

3

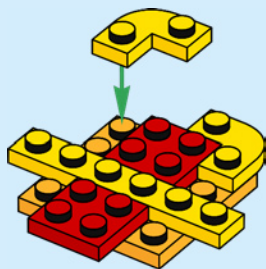



2x

4

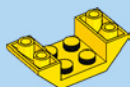
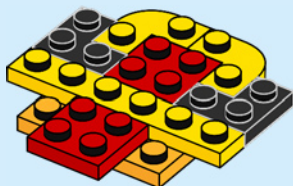

1x

5

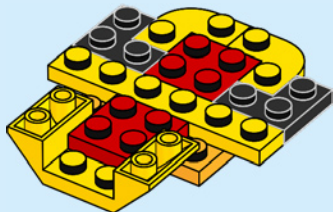



2x



1x

6

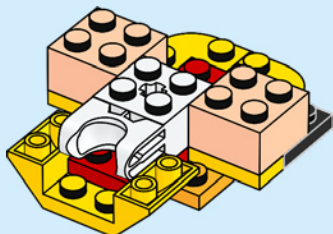

2x

7

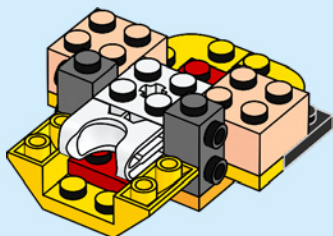



2x



4x

8

1

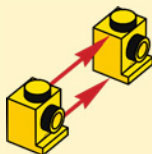

2

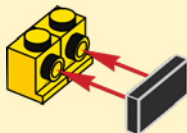

2x

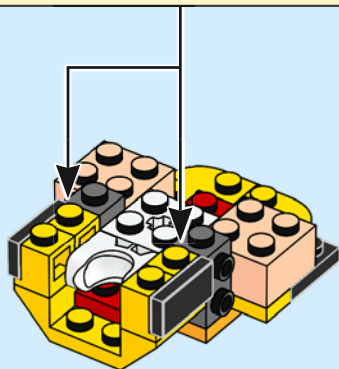



2x

9

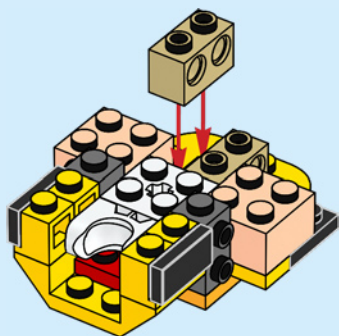

4x

10

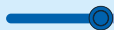
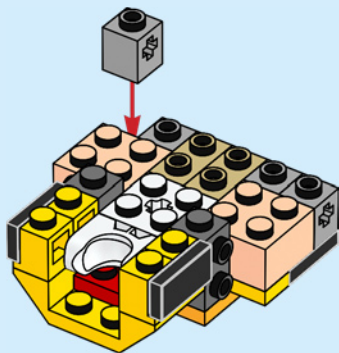

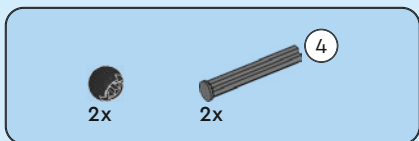

11

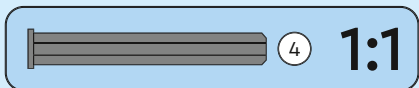
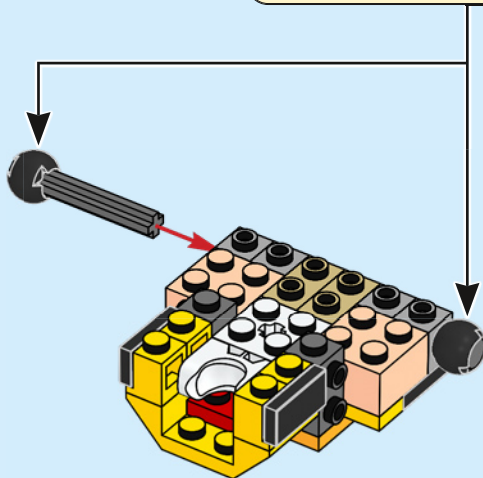
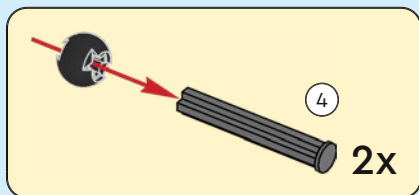



1x



4x

12

1

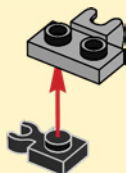

2

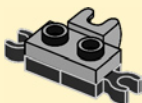

3

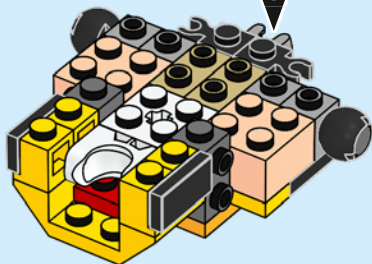

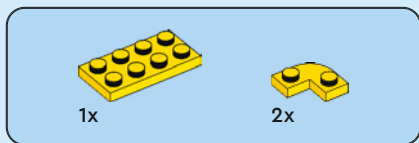

13

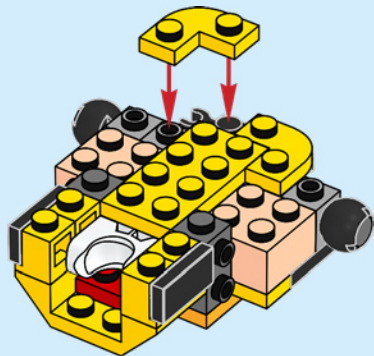

14

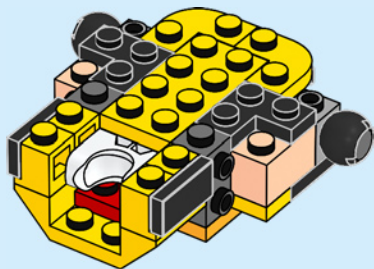



1x



1x

15

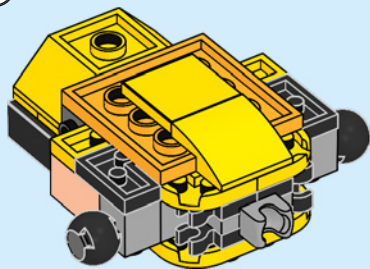



2x



2x

16

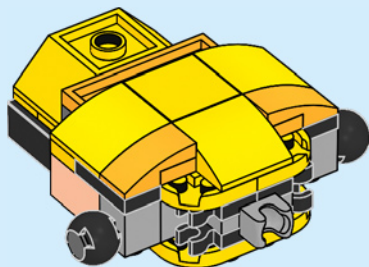

1x

17

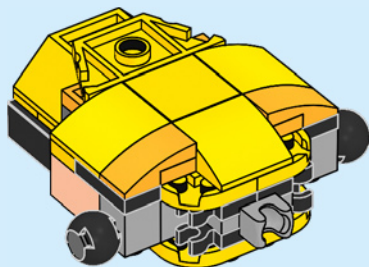

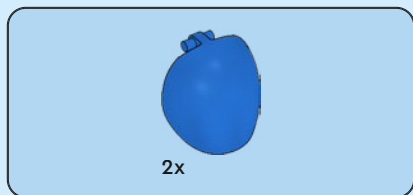

18

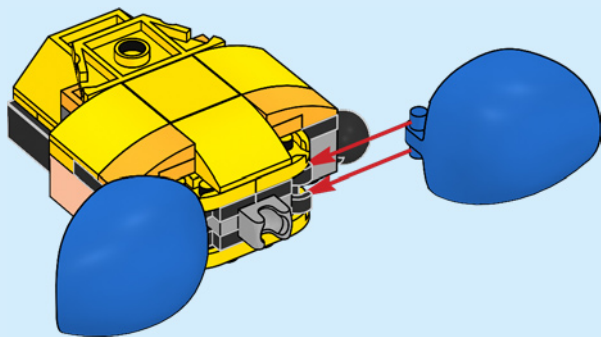



2x



2x

19

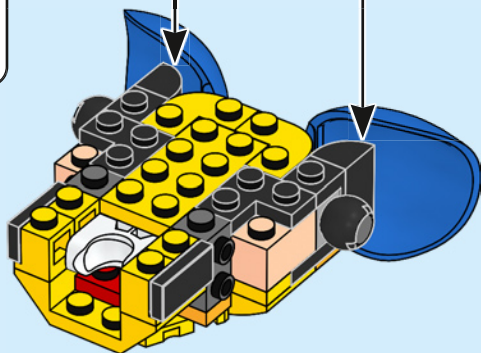
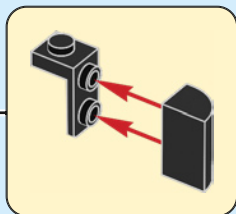
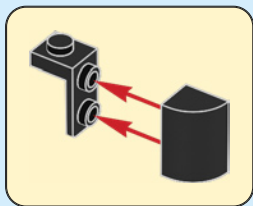



2x

20

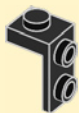

2x

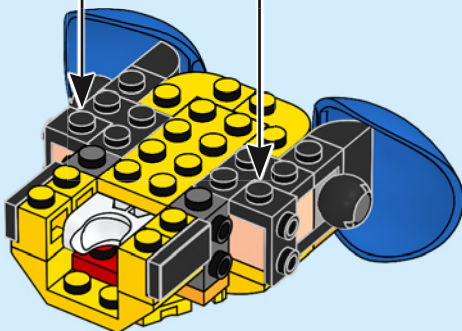



2x

21

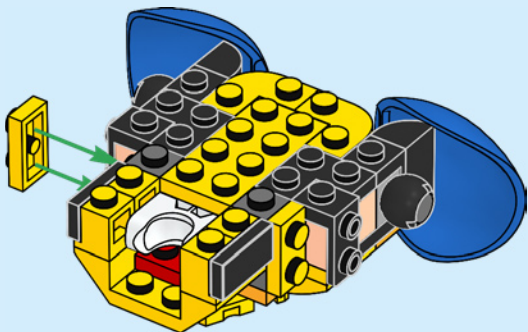

2x



2x

22

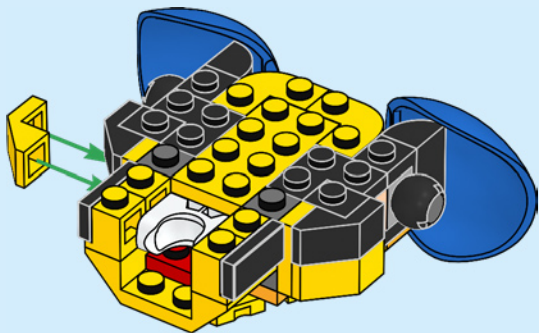

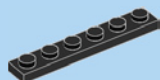

1x

23

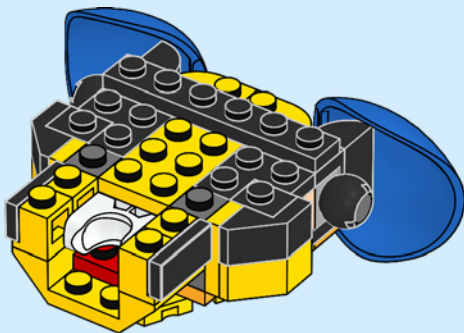



2x



1x

24

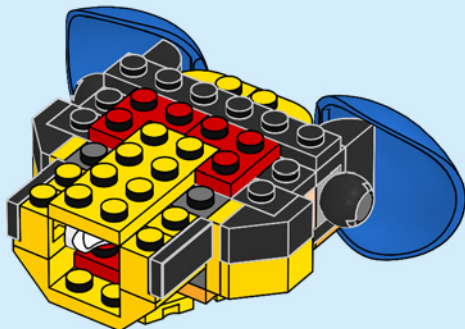

2x

25

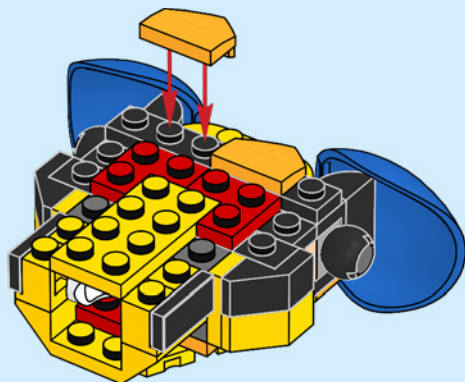



1x

26

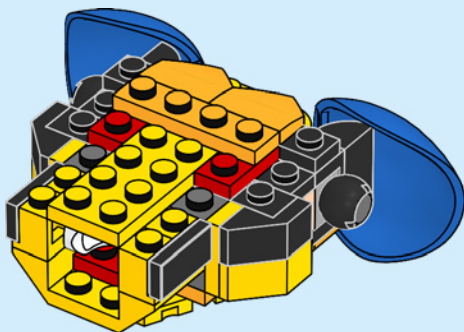



1x



1x

27

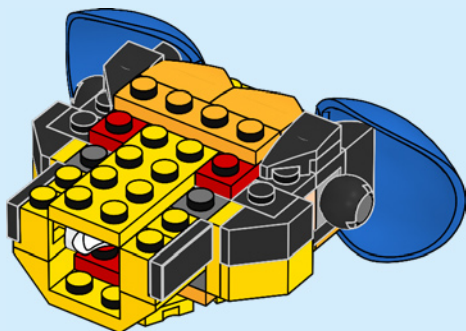

2x

28

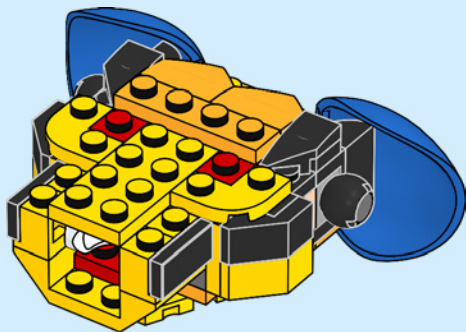



1x



1x

29

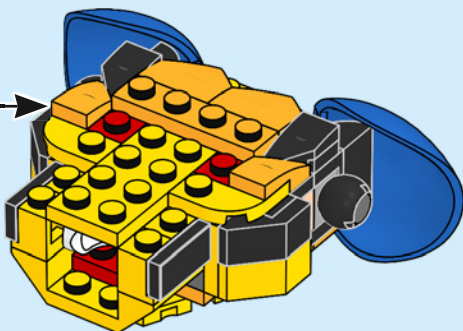

1x

30

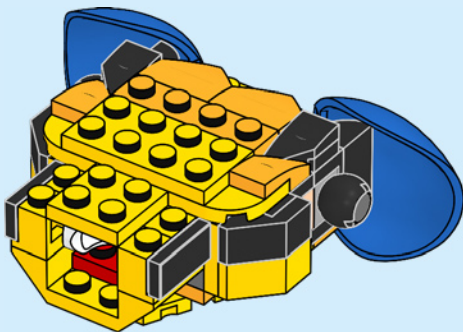



2x

31

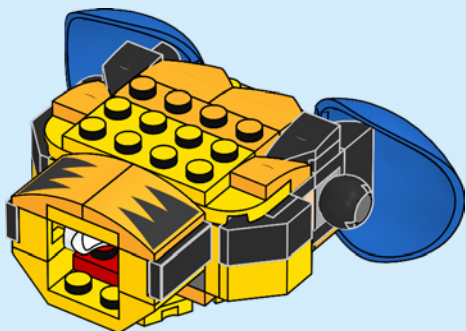

1x

32

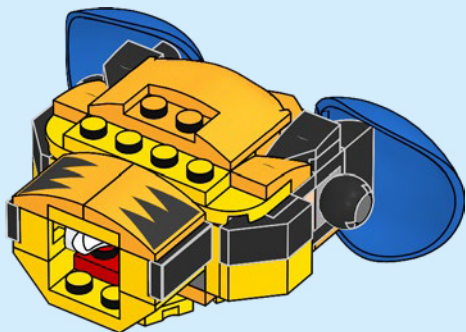



4x



1x



1x

33

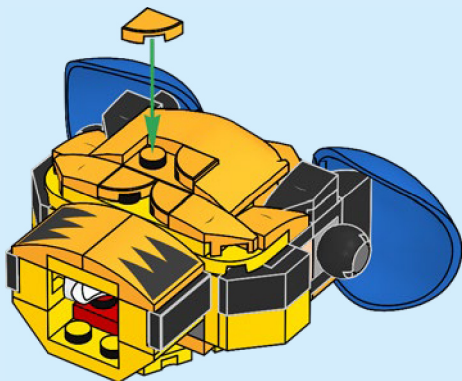

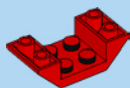

1x

34

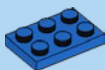
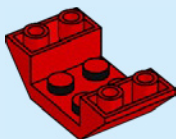

1x

35

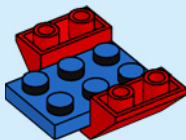



1x

36

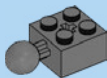
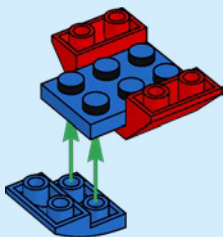

1x

37

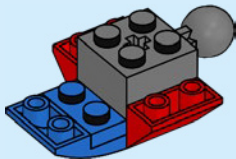



2x

38

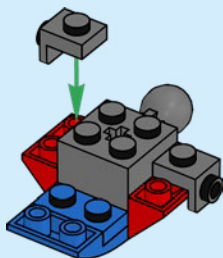

2x

39

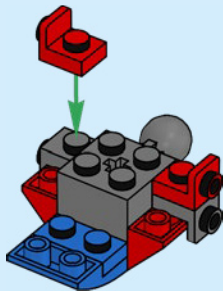



1x

40

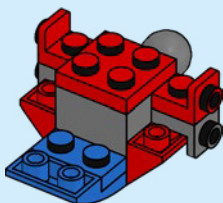

2x

41

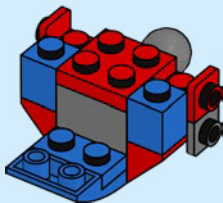



2x

42

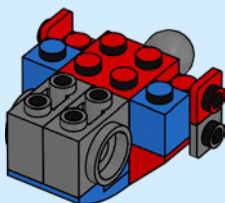

1x

43

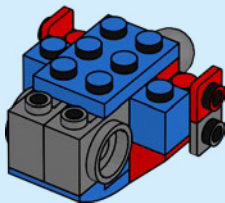



2x

44

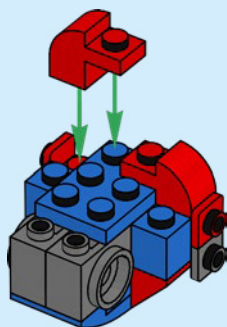

1x

45

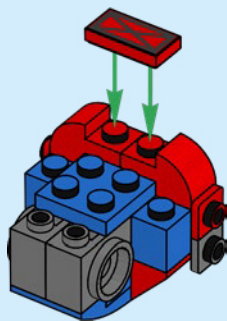



2x

46

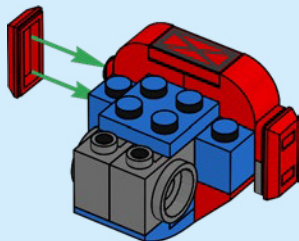

1x

47

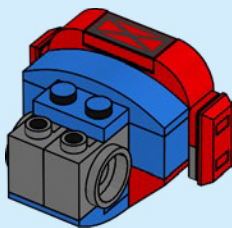



1x



1x



1x

48

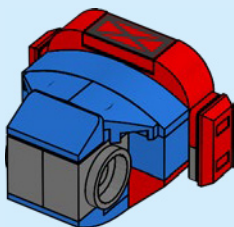

49

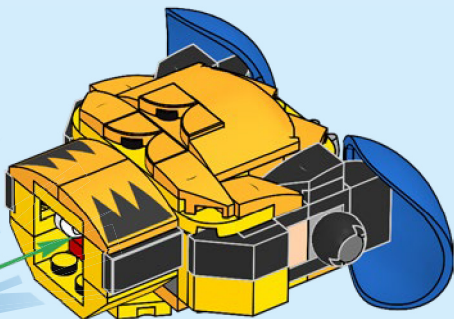
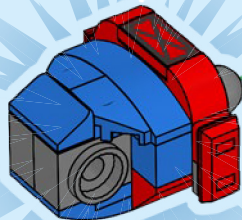



1x

50



1x



1x

51

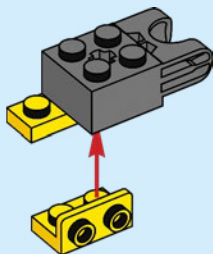



1x



1x

52

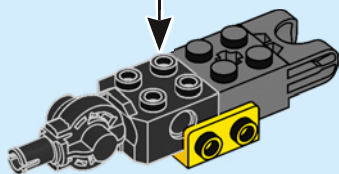
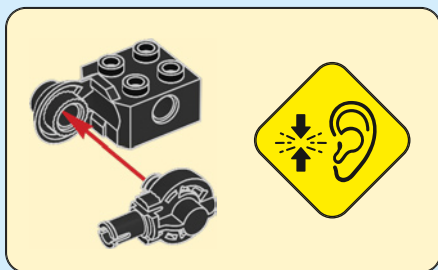

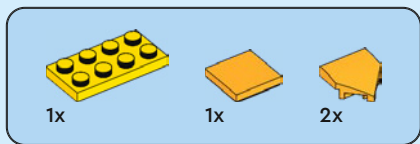

55

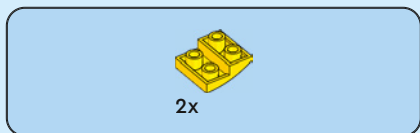
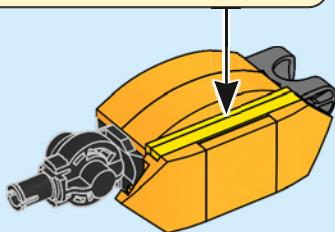
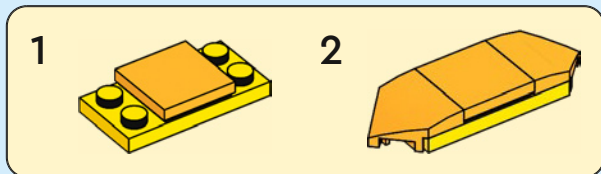

56

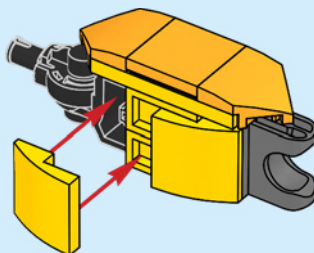

57

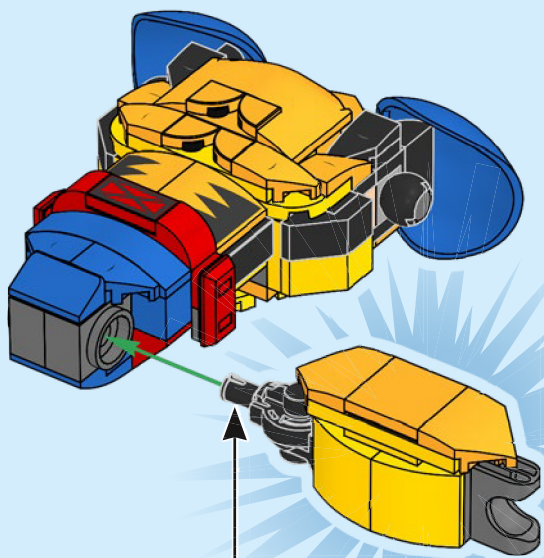



1x

58



1x



1x

59

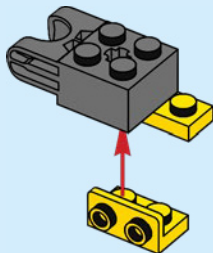

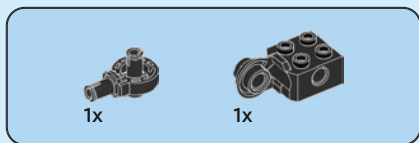

60

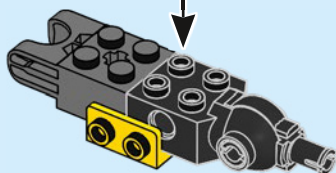
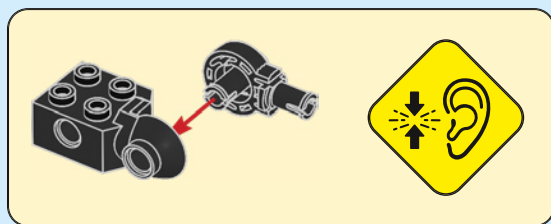



1x



1x

61

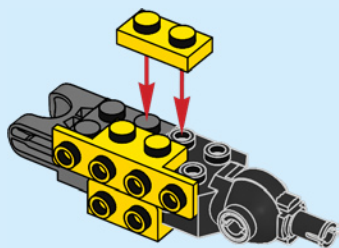

2x

62

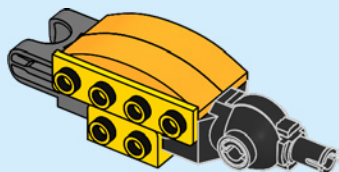

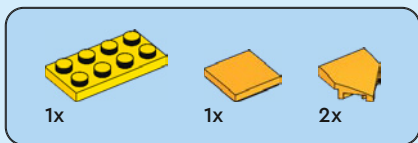

63

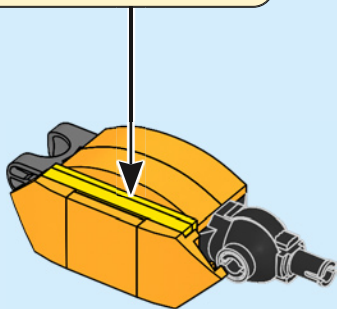
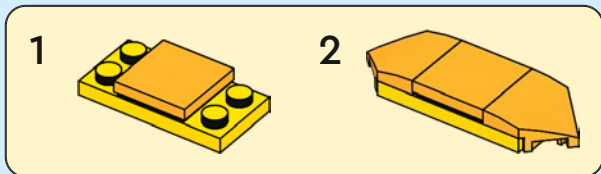



2x

64

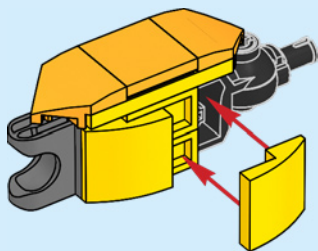

65

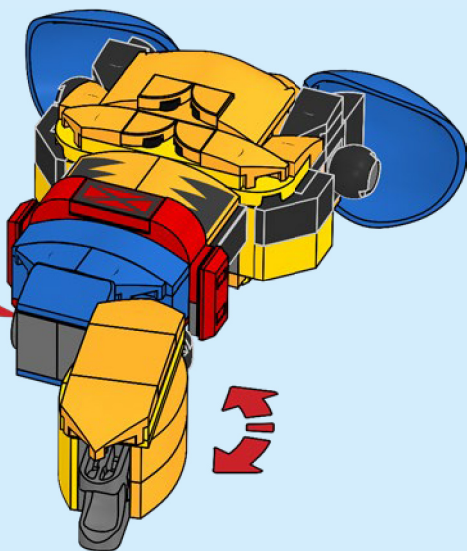
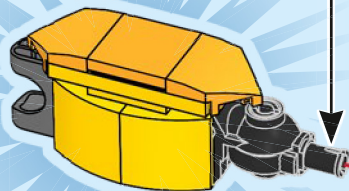



2x



1x



1x

66

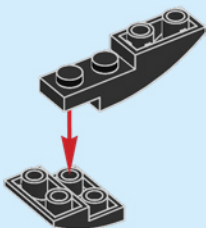

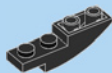

1x

67

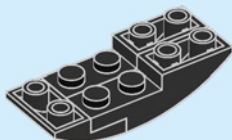

1x

68

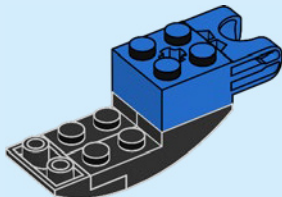

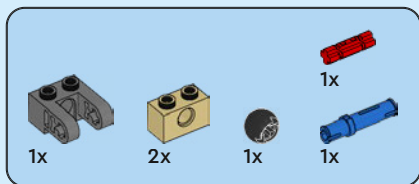

69

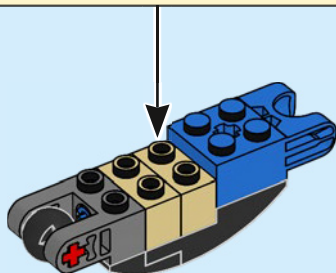
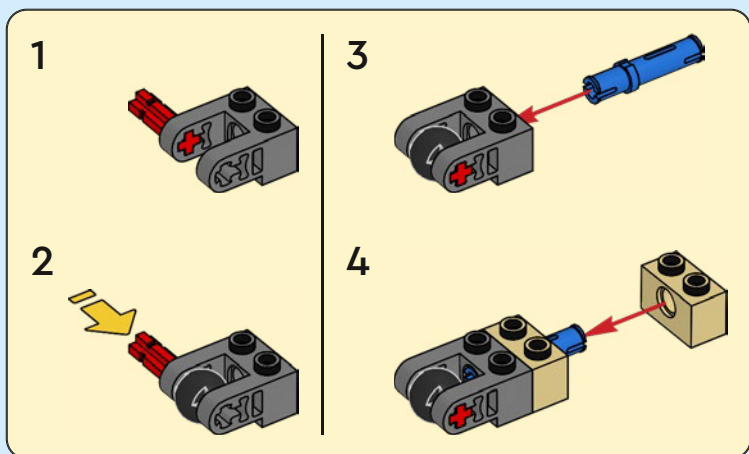



1x



1x

70

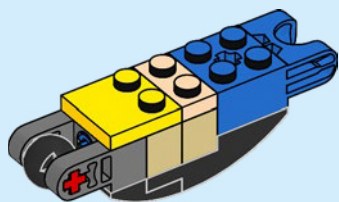

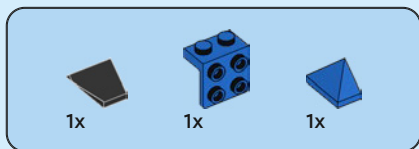

71

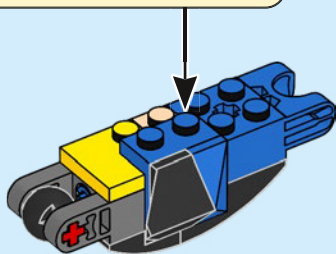

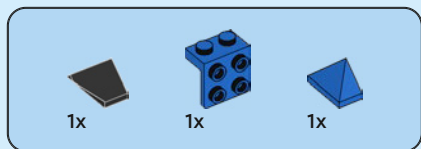

72

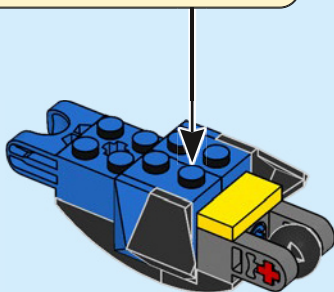



1x

73

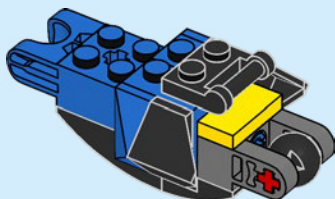

1x

74

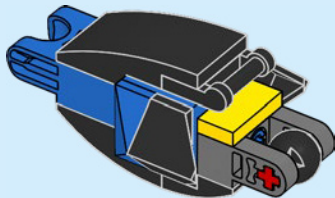



1x



1x



1x

75

1

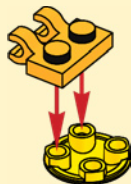

2

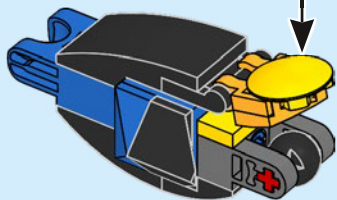

2x

76

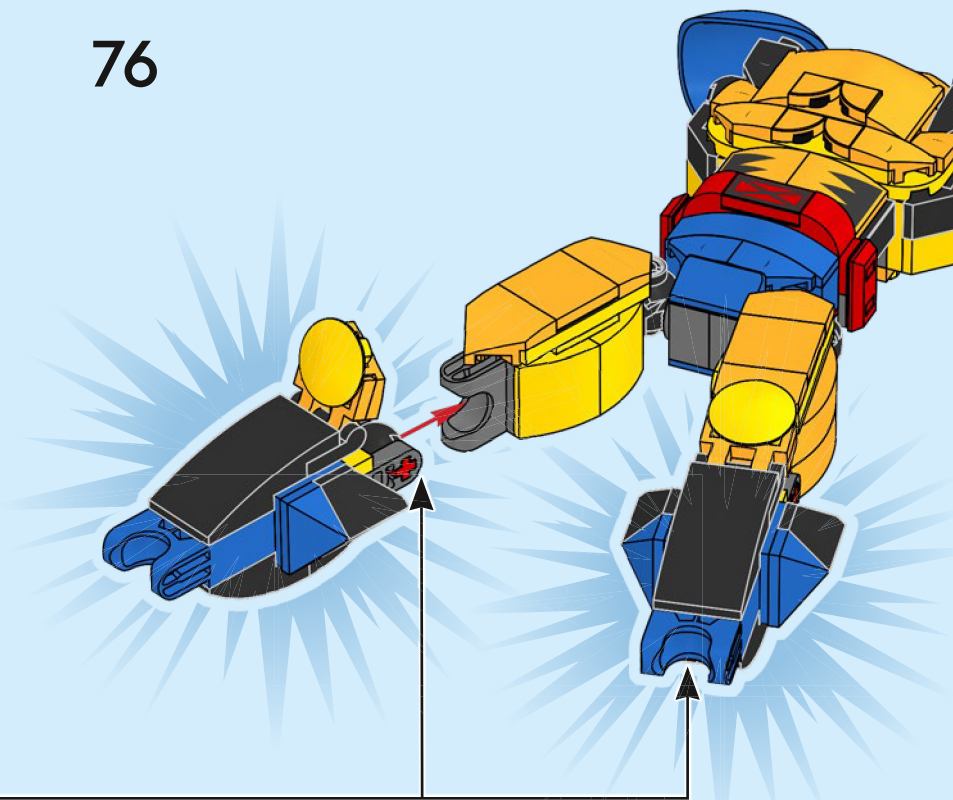

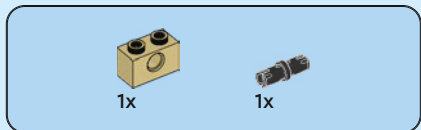
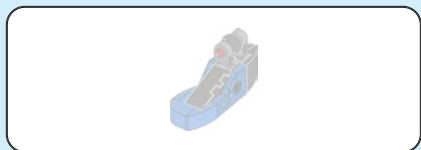

77

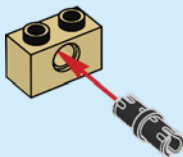



1x

78

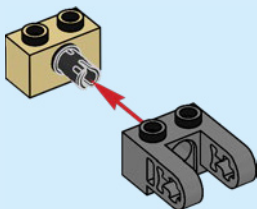

1x

79

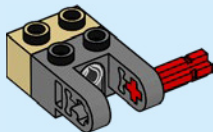



80

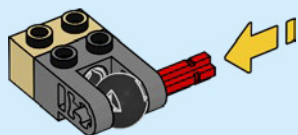

81

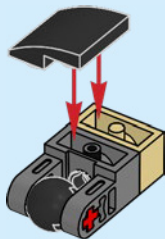



1x

82

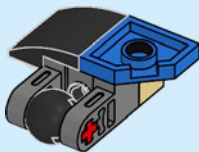

2x

83

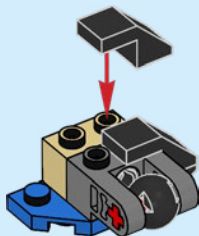



1x

84

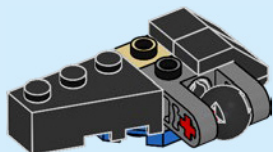

1x

85

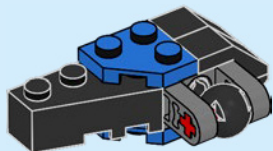

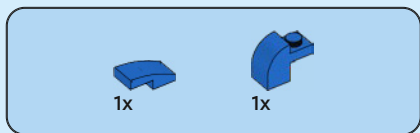

86

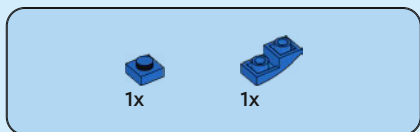
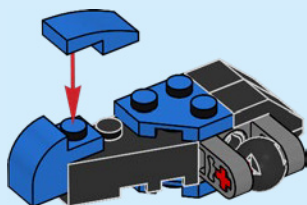

87

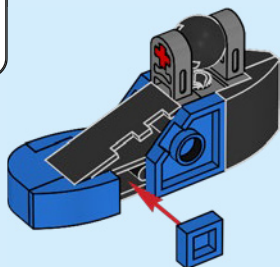

88

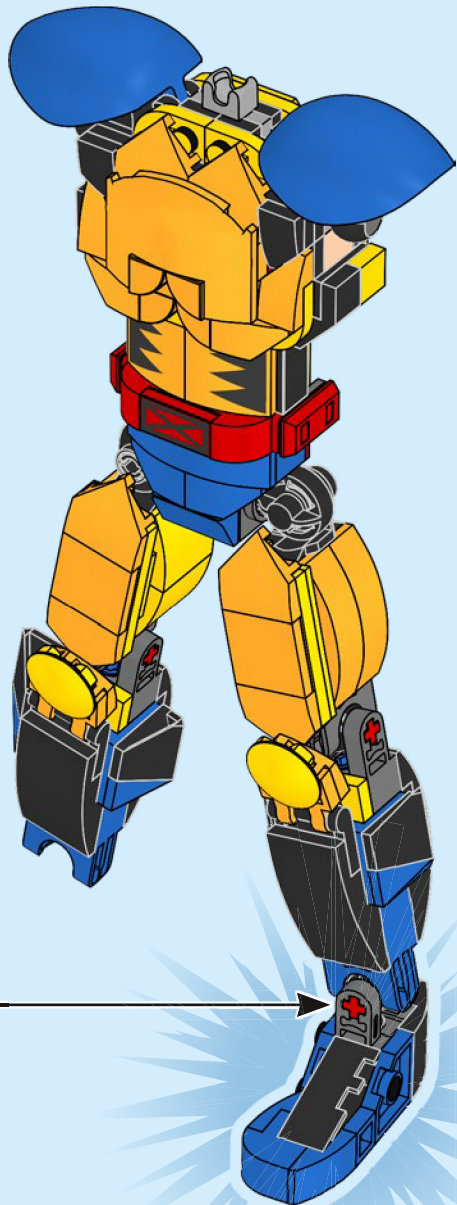

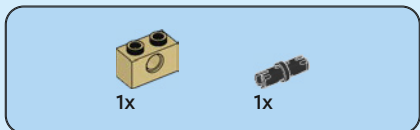
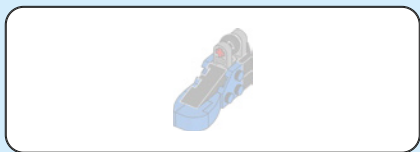

89

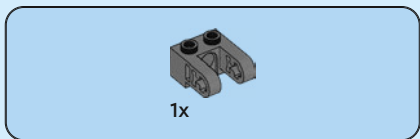
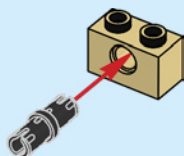

90

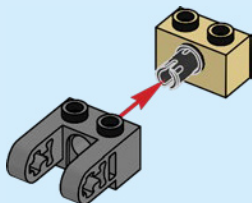



1x

91

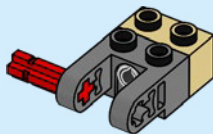

1x

92

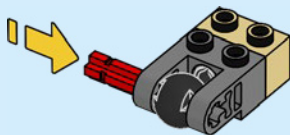



1x

93

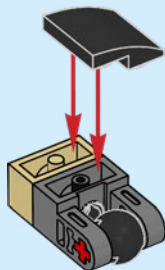

1x

94

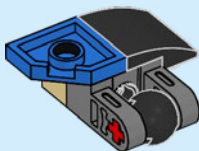



2x

95

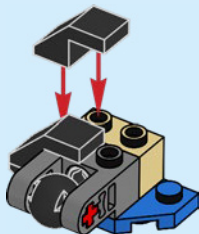



1x

96

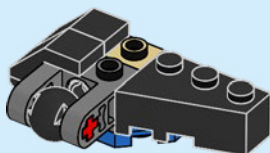

1x

97

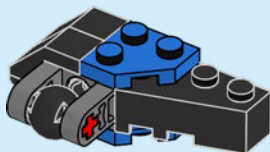



98

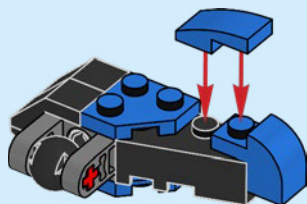

99

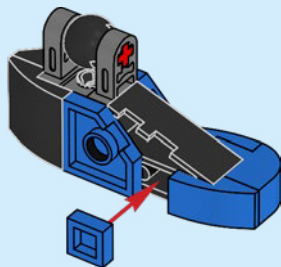

100

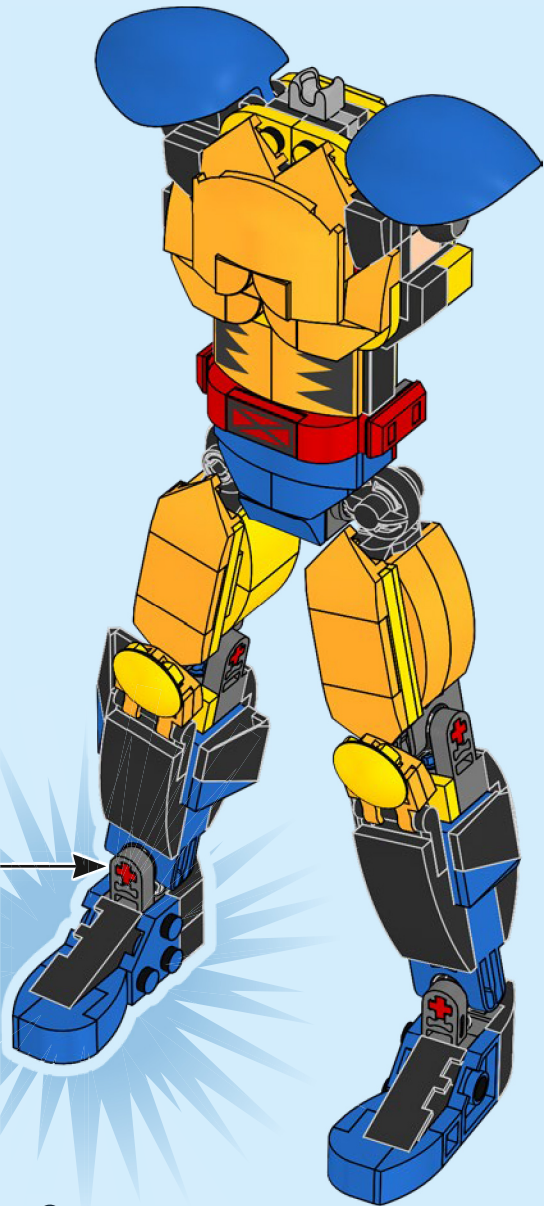



1x



1x

101

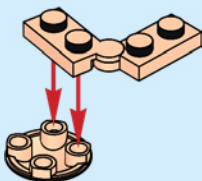

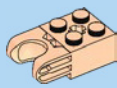

1x

102

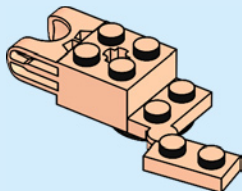

1x

103

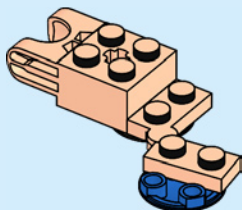



1x

104

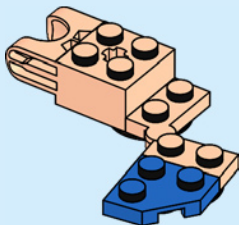

1x



1x

105

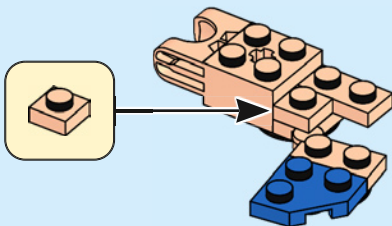



106

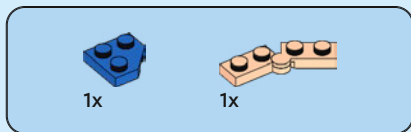
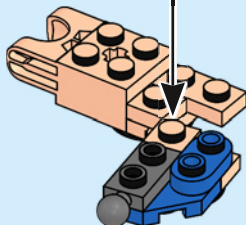

107

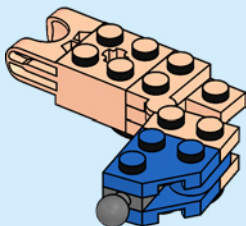



1x



1x

108

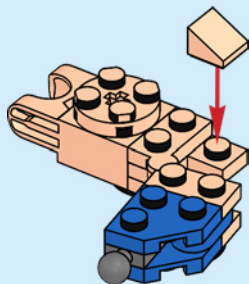

2x



2x

109

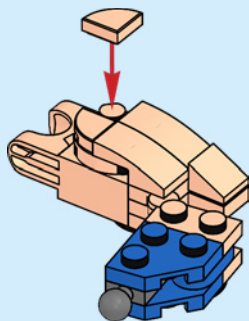



1x

110

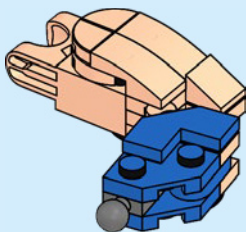

1x



1x

111

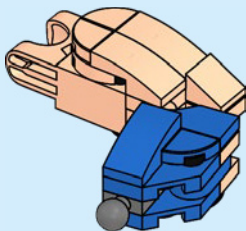

112

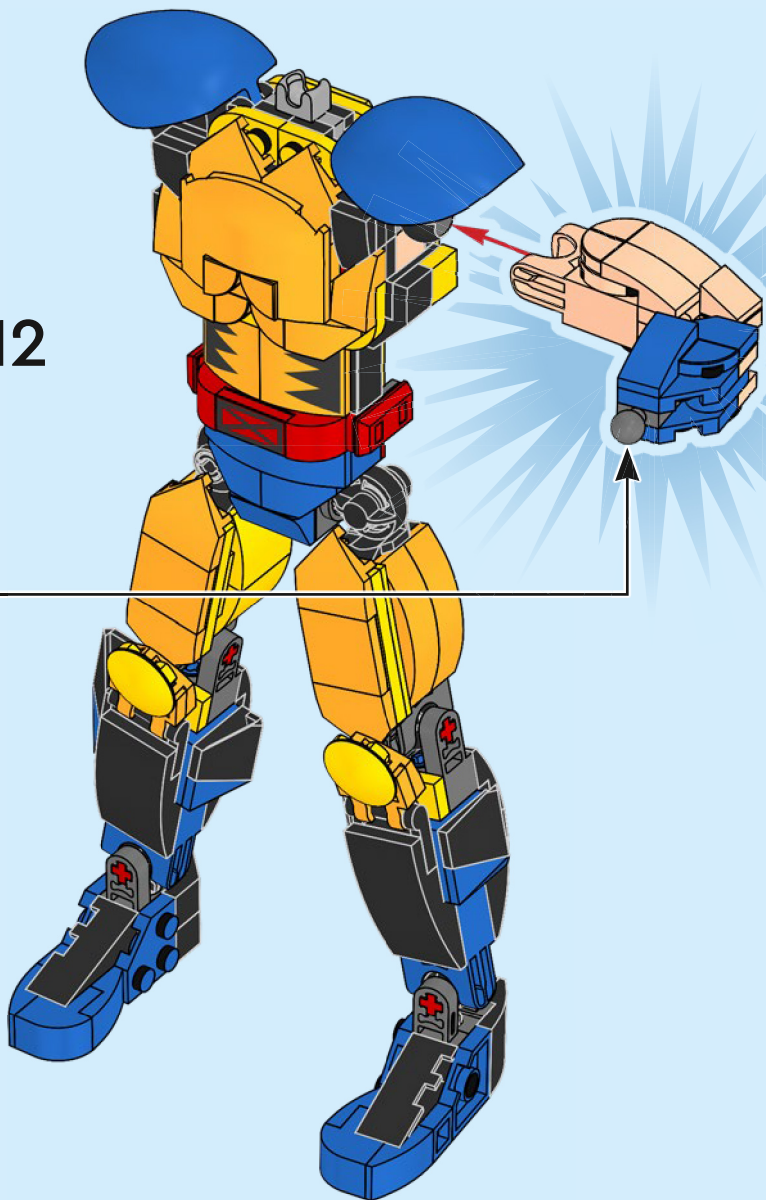

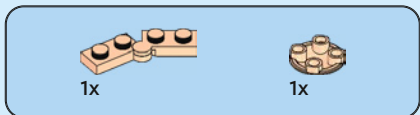
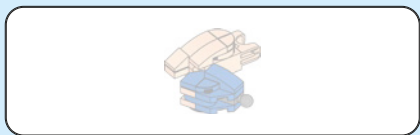

113

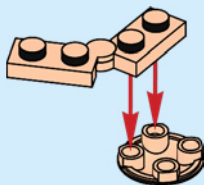

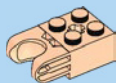

1x

114

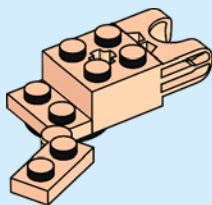

1x

115

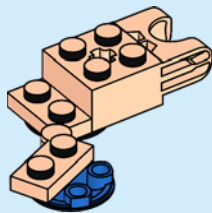



1x

116

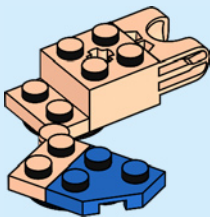

1x



1x

117

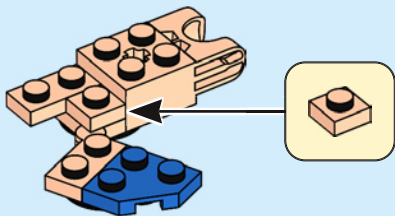



118

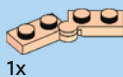
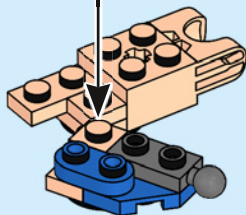

119

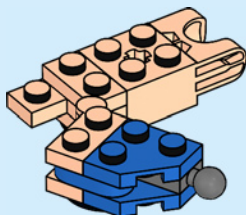



1x



1x

120

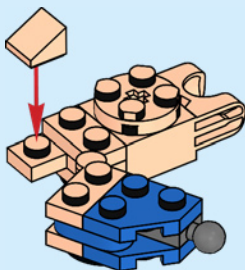

2x



2x

121

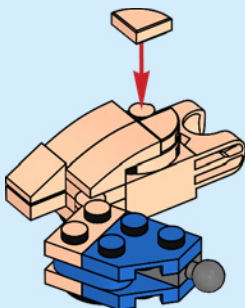



1x

122

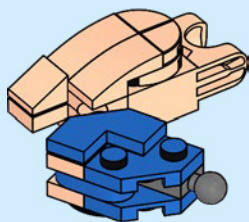

1x



1x

123

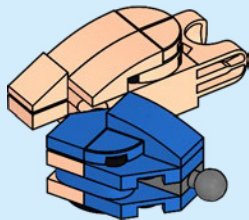

124

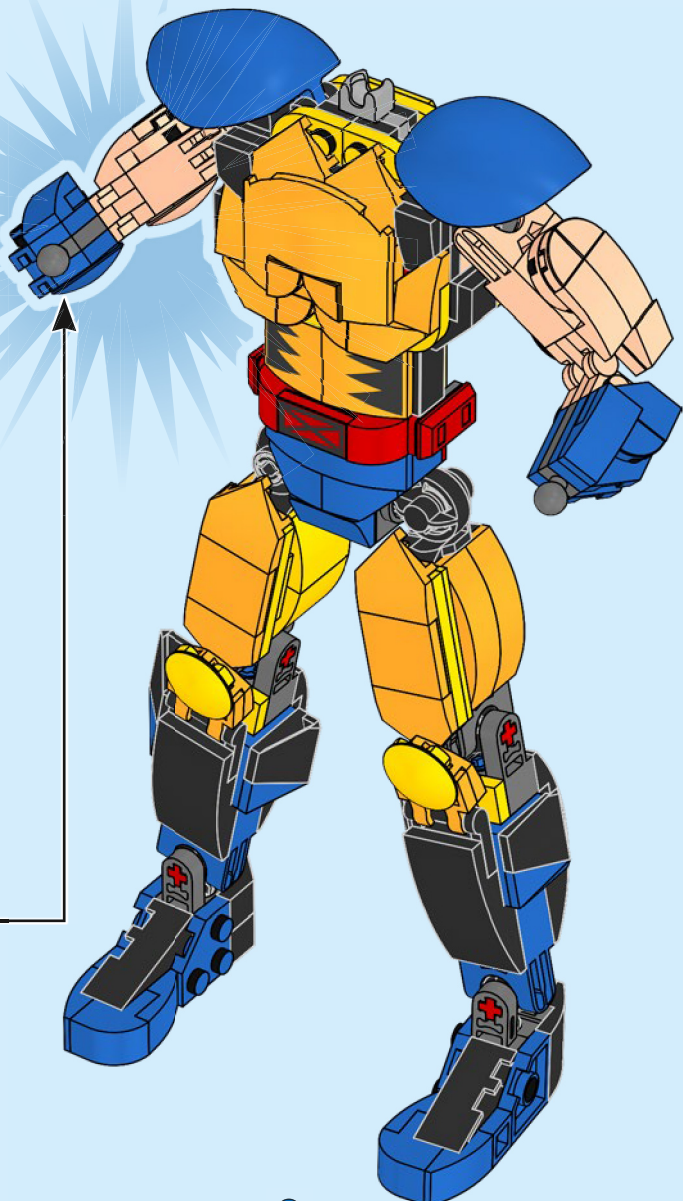

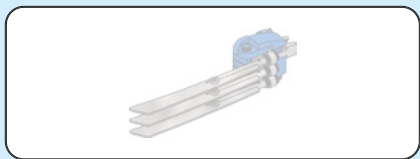

1x



1x

125

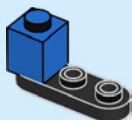

1x



1x

126

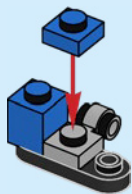



1x

127



1x

128

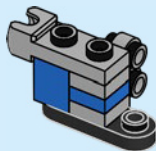



1x



1x

129



1x



1x

130

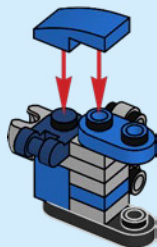

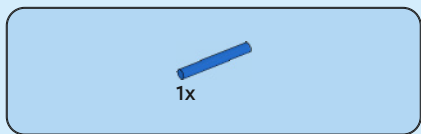

131

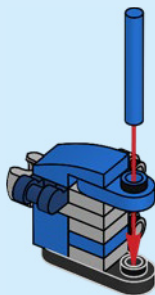

132

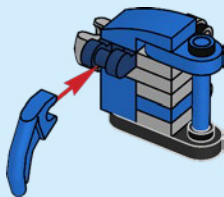



133

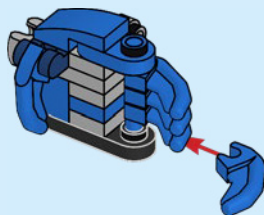

134

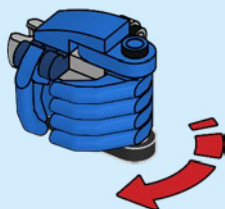

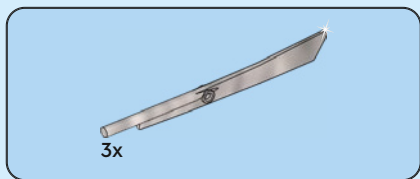

135

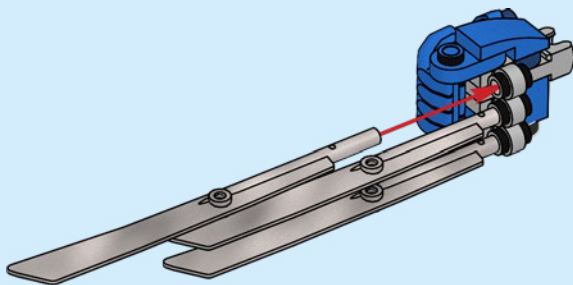

136

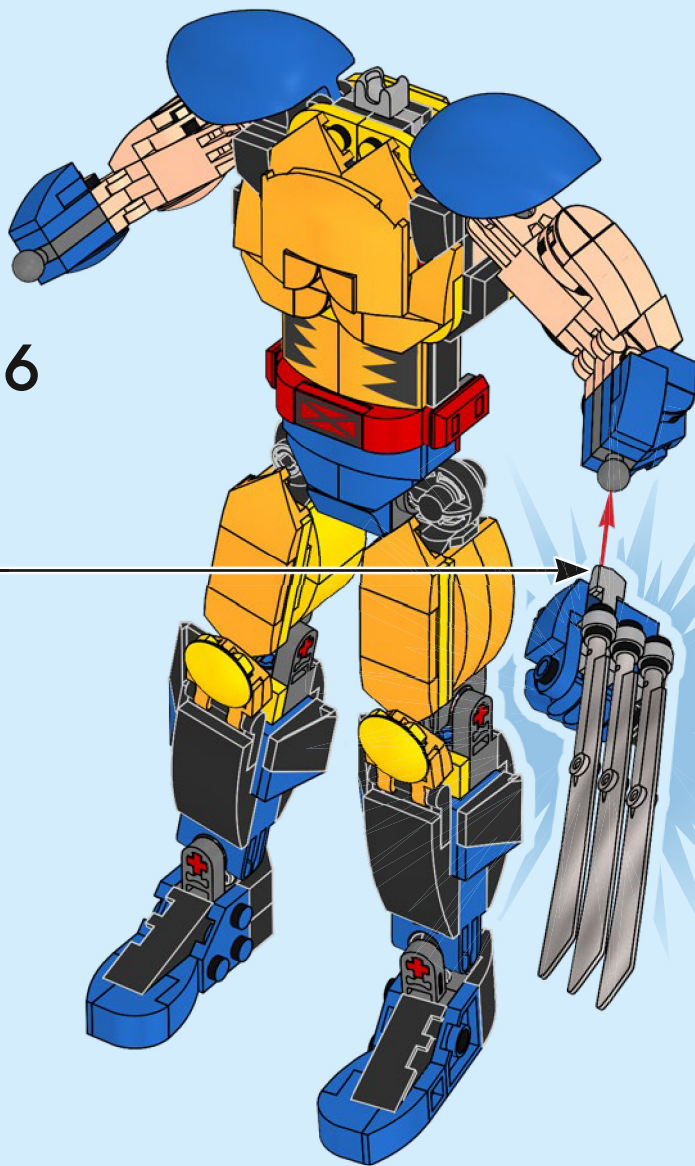

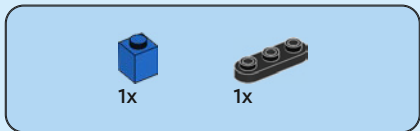
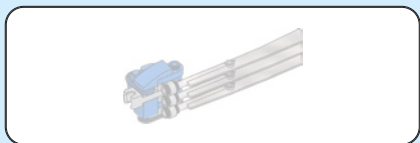

137

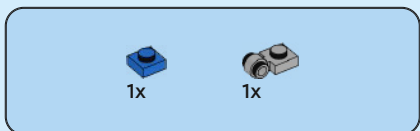
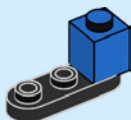

138

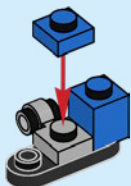



1x

139



1x

140

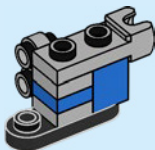



1x



1x

141



1x



1x

142

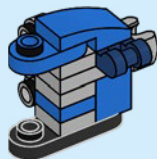



1x

143

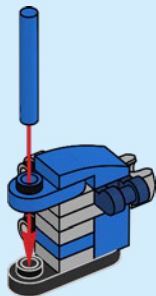

1x

144

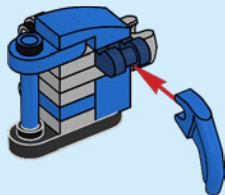



145

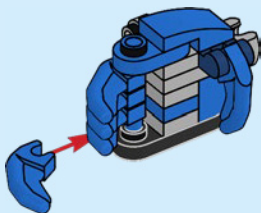

146



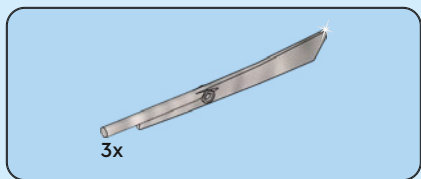

147

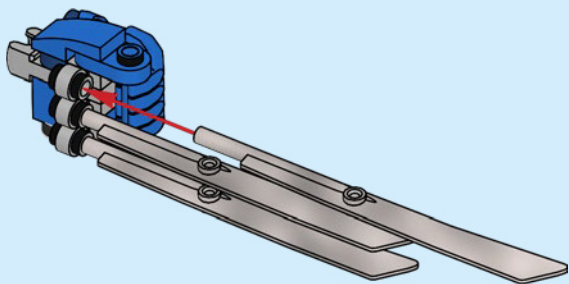

148

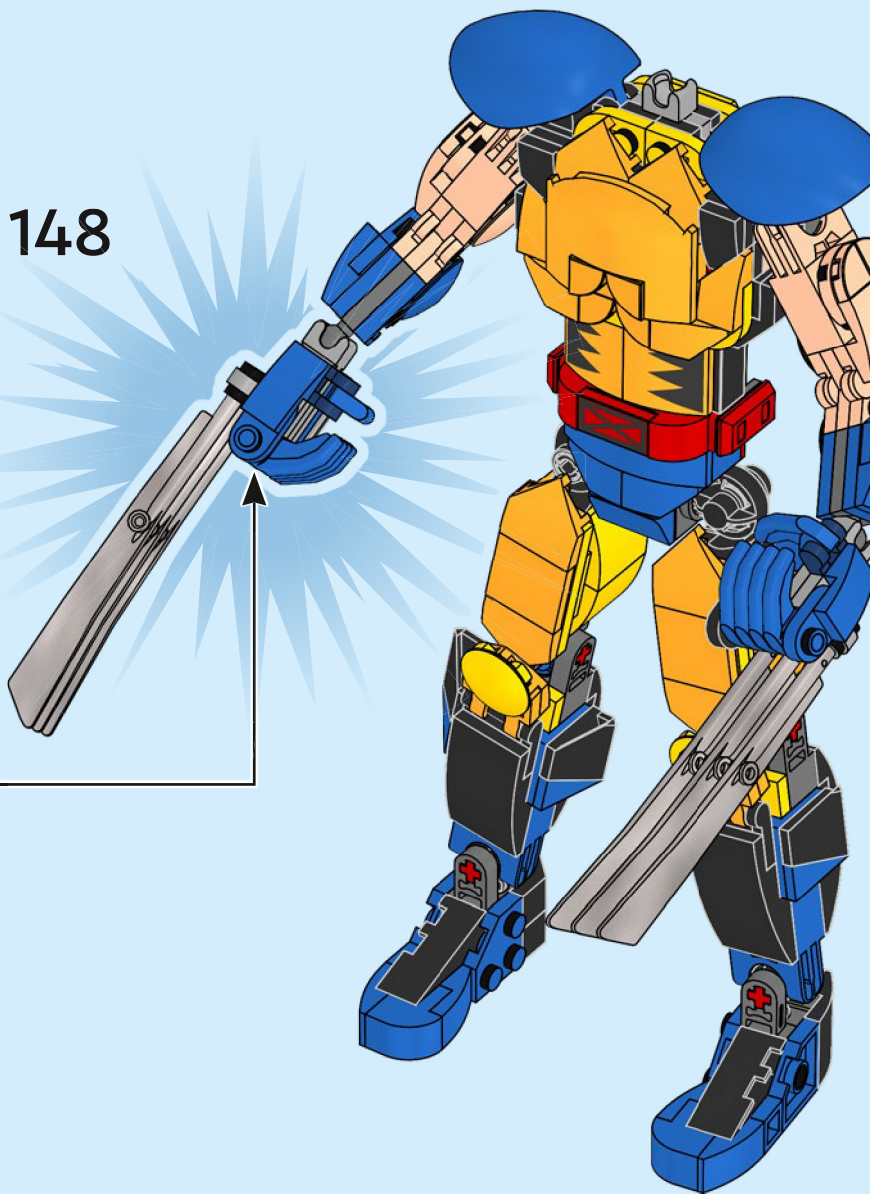



1x



1x

149

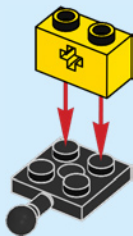



1x

150



2x

151





2x

152



1x

153



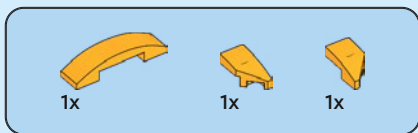

154

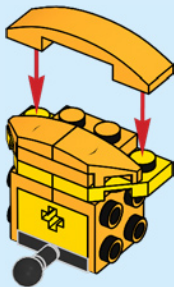

155

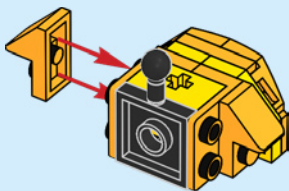



2x



2x

156

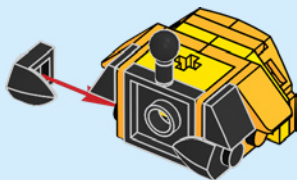

2x

157

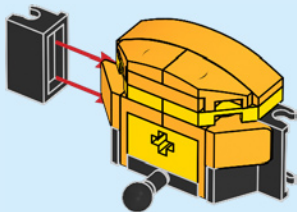

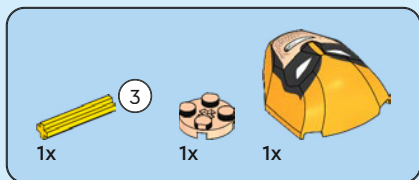

158

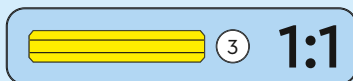
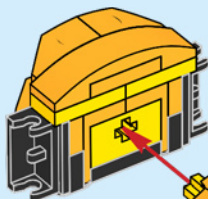
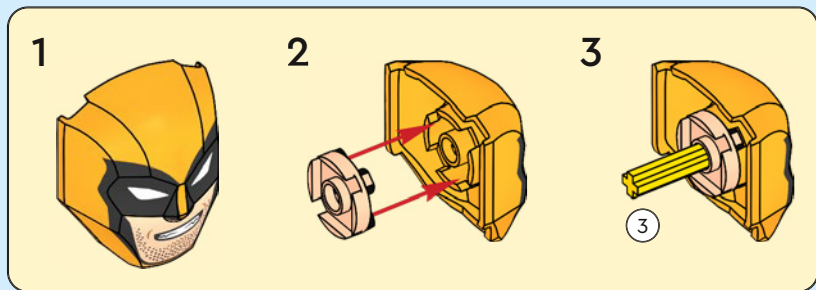

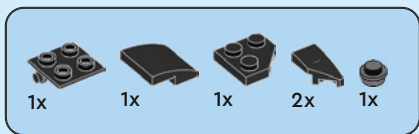

159

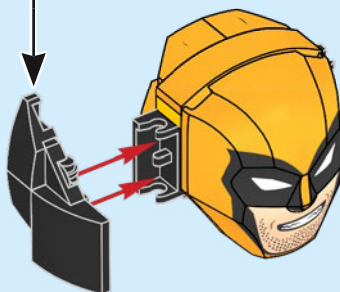
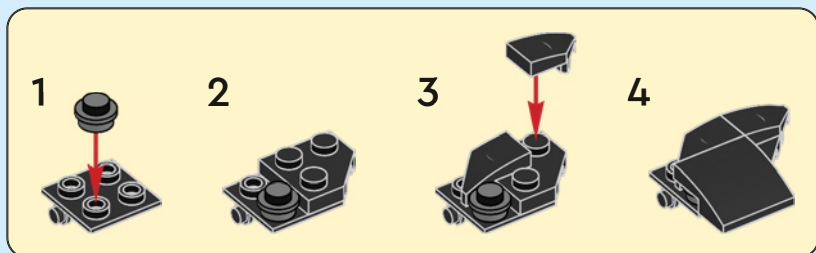

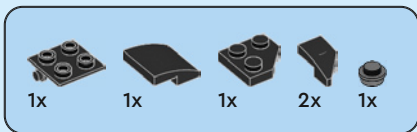



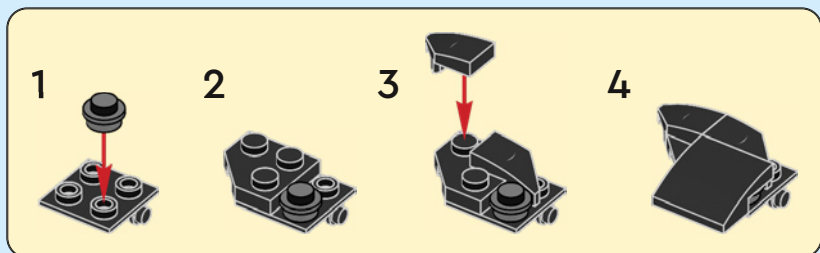



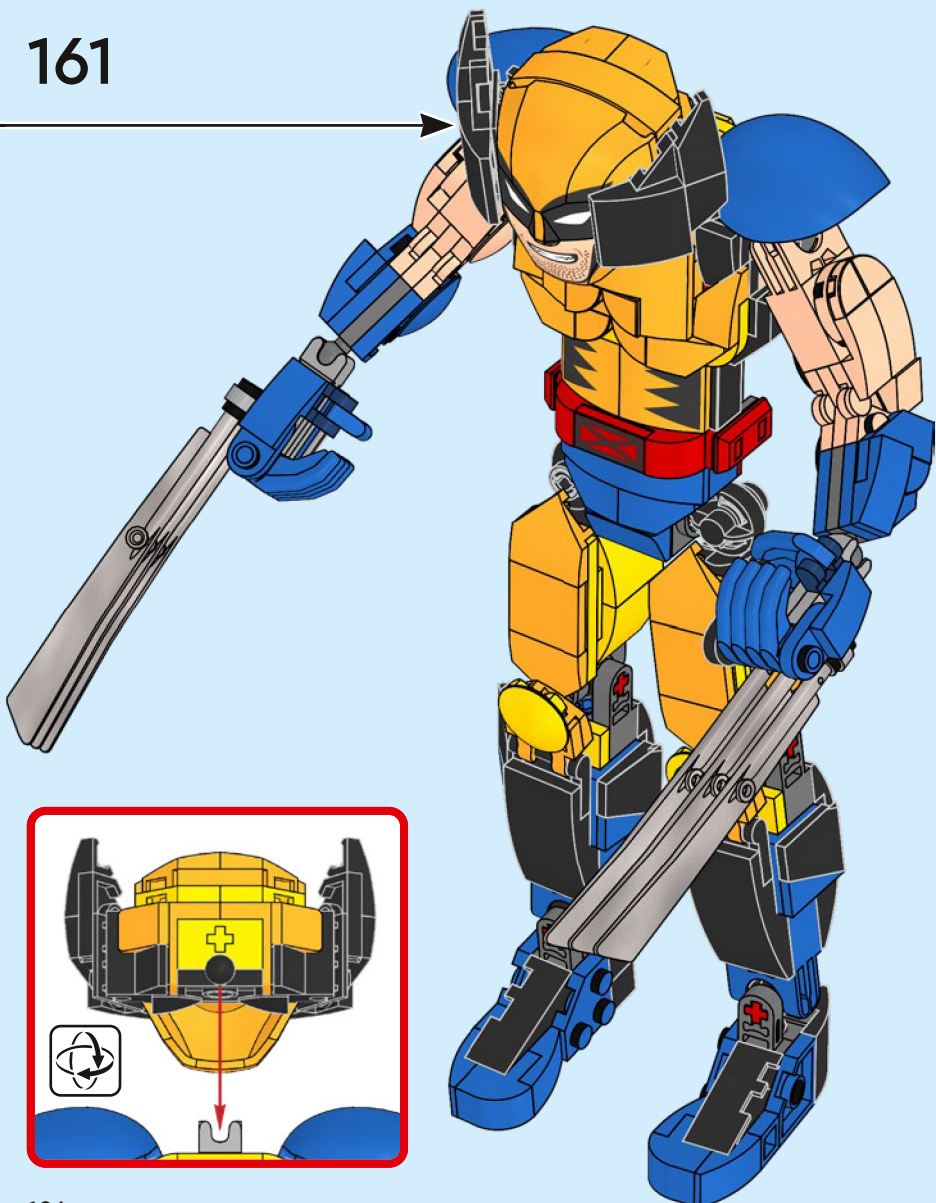

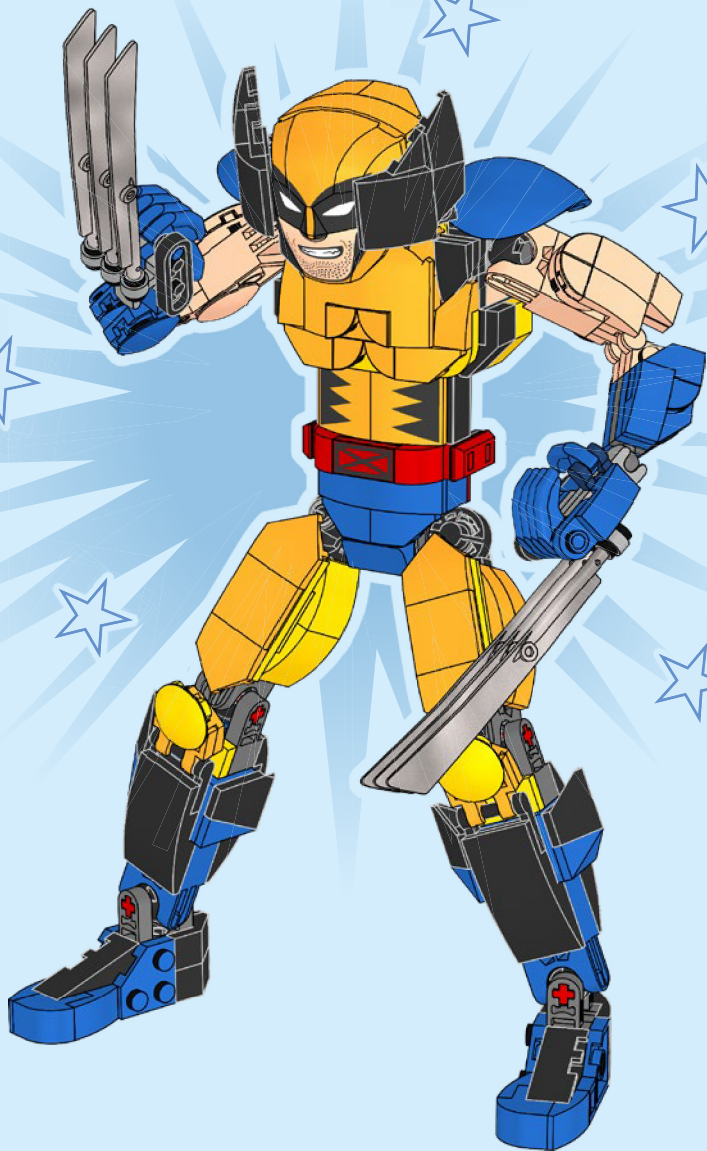

























































160



161





 1x 6172414	 2x 6347945	 2x 6249907	 2x 6228597	 6x 4286267
 4x 300523	 4x 6117968	 4x 4142865	 2x 6057458	 2x 4504382
 2x 6302961	 2x 6345634	 2x 6394880	 6x 6365891	 3x 6181720
 4x 302423	 1x 6307924	 2x 6184782	 7x 6411332	 2x 6173959
 10x 6447238	 2x 6299413	 1x 6443490	 1x 6411902	 4x 6380236
 4x 6315482	 2x 6333512	 2x 242021	 2x 6224666	 4x 6330189
 1x 6172411	 3x 302221	 3x 302221	 1x 6130007	 3x 6181713
 1x 4651236	 2x 6438567	 1x 487121	 2x 6168616	 4x 4220539
 4x 6249783	 2x 302123	 4x 407024	 1x 4260192	 2x 393726
 2x 4278276	 1x 4649773	 2x 6294771	 5x 302024	 2x 6174243
 8x 6390153	 2x 6406931	 2x 6195184	 1x 6215106	 6x 6267487
 6x 6055065	 2x 6251253	 2x 6206240	 2x 6215106	 2x 306926
 2x 6308097	 1x 6360826	 6x 302324	 1x 366624	 2x 6275732

2x
4225201

2x
4213374

2x
4124096

2x
6053077

4x
242026

4x
6211476

1x
6448318

1x
4526931

1x
4527766

4x
6039869

2x
6302828

2x
4647286

1x
366626

3x
6289747

4x
6214457

3x
6289745

2x
6330901

8x
6339302

2x
6145215

2x
6134634

2x
6337271

2x
6443491

2x
6020147

5x
6133826

1x
6020073

1x
6218142

1x
6003033

1x
6093272

1x
6443489

4x
6336539

6x
6281998

1x
6043656

2x
6043639

2x
4523145

6x
4205107

6x
6378729

1x
4497253

2x
6338291

2x
4210633

2x
6228923

2x
6413106

2x
6398662

2x
6123814

4x
6324639

2x
6083620

4x
6275872

2x
6357792

4x
6357797

3x
6384589

2x
6438565

4x
6369188

4x
6357796

2x
6297283

2x
6433890

4x
6438564

4

 [LEGO.com/service](https://www.LEGO.com/service)

YOU COULD

WIN



Scan this QR code or go to
LEGO.COM/PRODUCTFEEDBACK
and give us your short feedback
about this LEGO® set for a chance
to win a cool LEGO prize.

Terms and Conditions apply*

DE: Du könntest GEWINNEN. Es gelten die Teilnahmebedingungen* **FR: Tu pourrais GAGNER.** Des conditions s'appliquent* **IT: Potresti VINCERE tu.** Termini e condizioni sono applicabili* **ES: Puedes GANAR.** Aplican términos y condiciones* **PT: Poderá GANHAR.** Aplicam-se termos e condições* **JA: プレゼント付き! 利用規約が適用されます*** **ZH: 轻松获奖. 条款和条件适用*** **KO: 상품의 주인이 되어보세요. 소정의 약관이 적용됩니다*** **RU: Вы можете ВЫИГРАТЬ.** Действуют положения и условия* **PL: Szansa na WYGRANĄ.** Obowiązują warunki korzystania* **CS: Máte šanci VYHRÁT.** Platí všeobecné smluvní podmínky* **SK: Máte šancu VYHRÁŤ.** Platia všeobecné zmluvné podmienky* **HU: TE IS NYERHETSZ.** Felhasználási feltételek érvényesek* **RO: Ai putea CÂȘTIGA.** Se aplică termeni și condiții* **BG: Можете да СПЕЧЕЛИТЕ.** Има определени правила и условия* **LV: Tu vari LAIMĒT.** Ir spēkā noteikumi un nosacījumi.* **ET: Sul on võimalus VÕITA.** Kehtivad tingimused* **LT: Jūs galite LAIMĖTI.** Taikomos sąlygos*

*[LEGO.com/productfeedback-terms](https://www.lego.com/productfeedback-terms)