



# SONIC™

THE HEDGEHOG

76992





FR  
**DONNEZ  
OU  
RECYCLEZ**



ASSOCIATION

OU



MAGASIN

OU



DÉCHÈTERIE

Adresses sur [quefairedemesdechets.fr](http://quefairedemesdechets.fr)



[LEGO.com/sustainable-packaging](http://LEGO.com/sustainable-packaging)

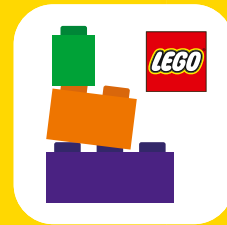

# BUILDER



Apple and the Apple logo are trademarks of Apple Inc., registered in the U.S. and other countries and regions. App Store is a service mark of Apple Inc. Google Play and the Google Play logo are trademarks of Google LLC. Tencent and the Tencent logo are trademarks of Tencent Inc.

Q [LEGO.com/devicecheck](https://www.lego.com/devicecheck)

EN Ask parents' permission before going online | DE Eltern um Erlaubnis bitten, bevor du online gehst | FR Demande l'autorisation d'un parent avant d'aller en ligne | IT Chiedi il permesso ai tuoi genitori prima di andare online | ES Pídeles permiso a tus papás antes de conectarte a Internet | PT Pede autorização aos pais antes de acederes online | ZH 上网前应先征得父母的同意 | PL Poproś rodziców o zgodę, zanim wejdiesz do Internetu | CS Než půjdeš na internet, požádej rodiče o svolení | SK Skôr než pôjdeš na internet, vypýtaj si povolenie od rodičov | HU Kérj szülői engedélyt, mielőtt online csatlakoznál! | RO Cere permisiunea părinților înainte de a te conecta online | BG Поискайте разрешение от родител, преди да влезете онлайн | LV Pirms došanās tiešsaistē palūdz atļauju vecākiem | ET Enne Interneti kasutamist küsi vanematelt luba | LT Prieš prisijungdami prie interneto, atsklauskite tėvų

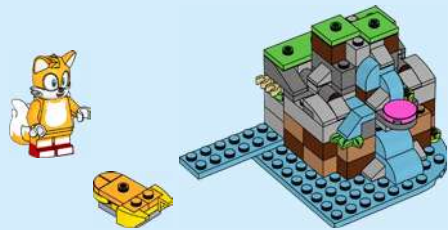
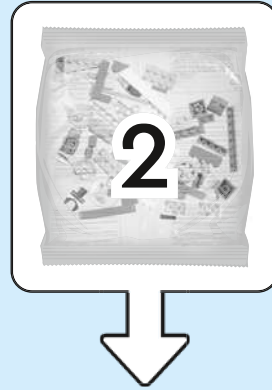



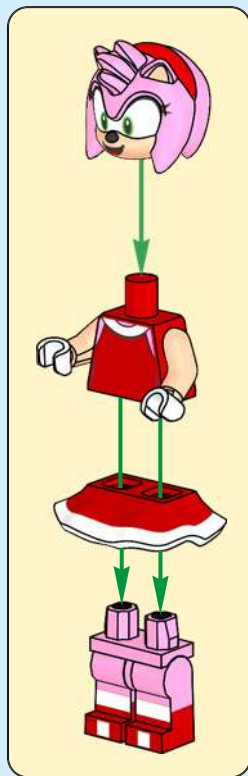

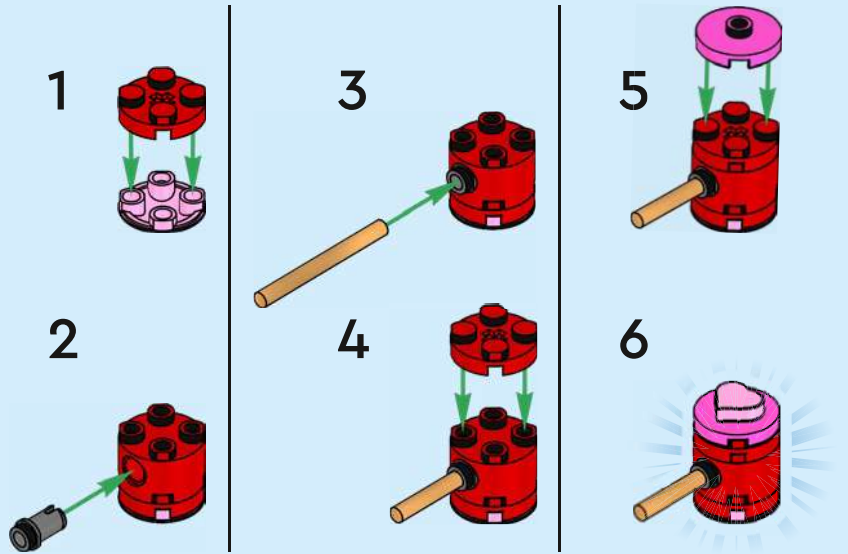

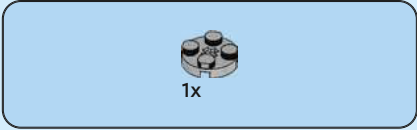
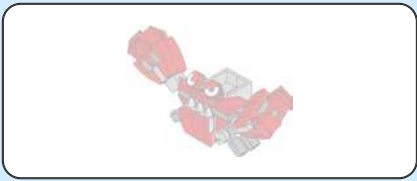

1



2

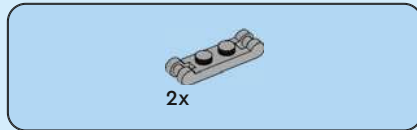
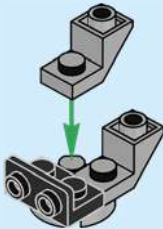

3

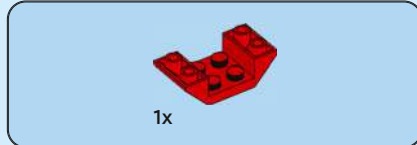

4

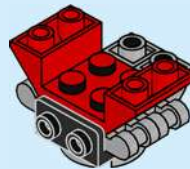



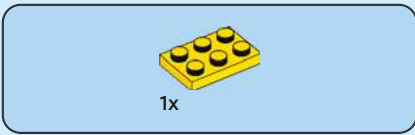

5

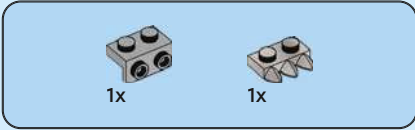

6

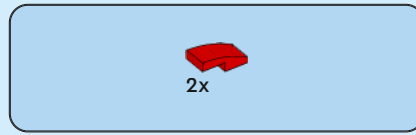
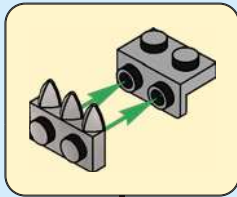

7

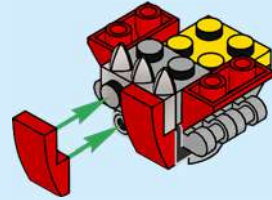

8

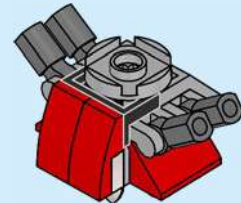
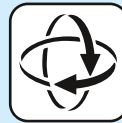



2x

9

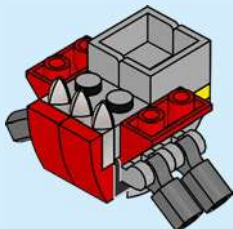

2x

10



2x



1x

11

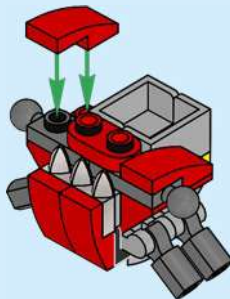

2x



2x

12

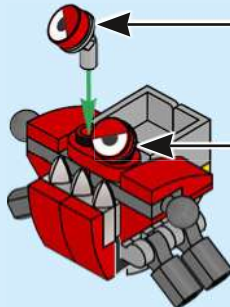

2x

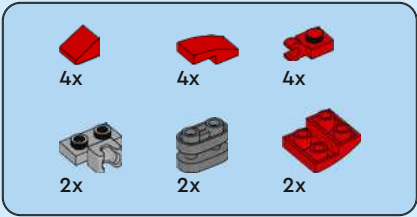

# 13

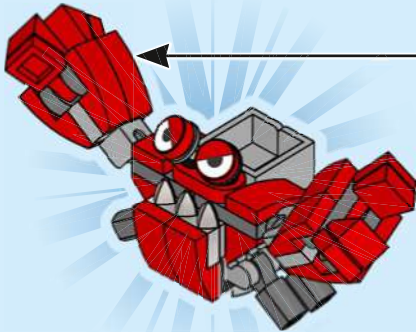
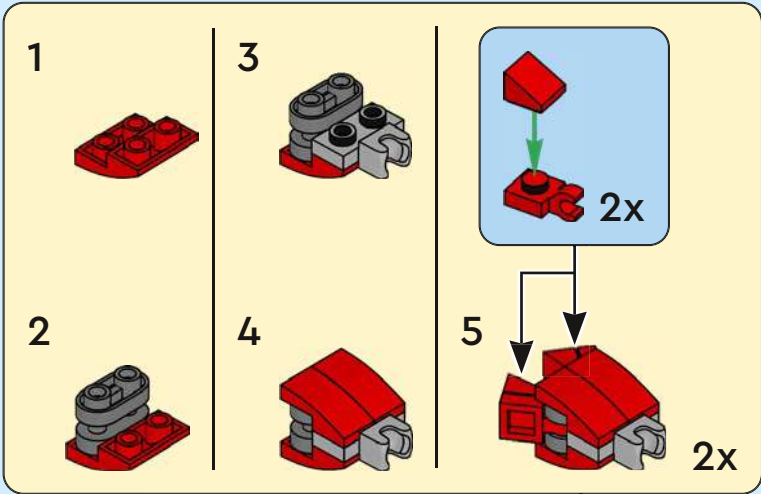

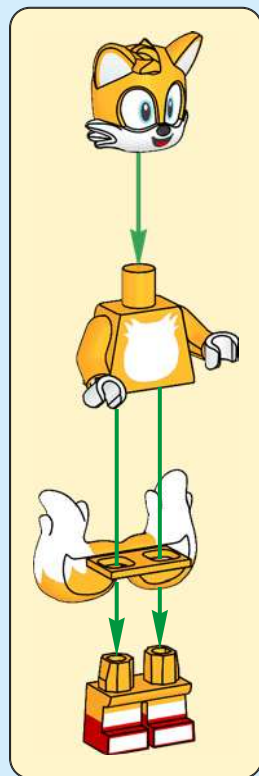



1x

1

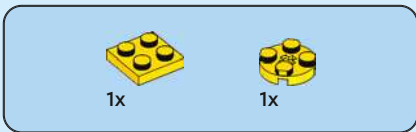

1x

1x

2

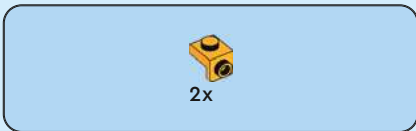
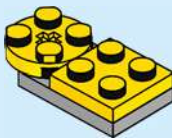

2x

3

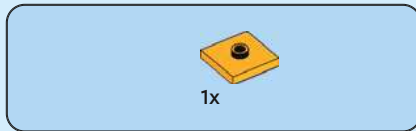
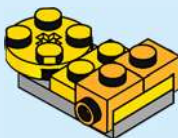

1x

4

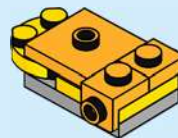

2x

5

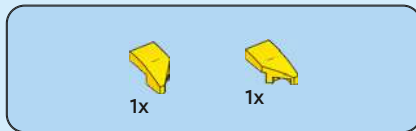

1x

1x

6



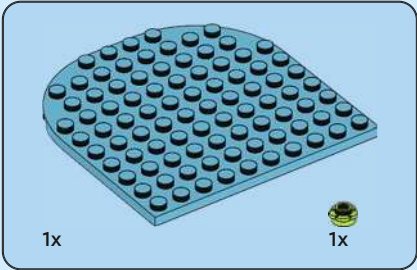
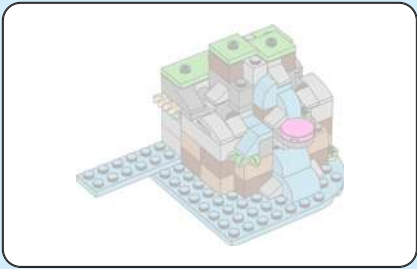

1

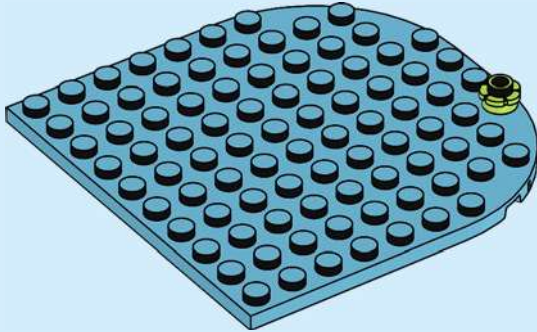



1x



1x

2

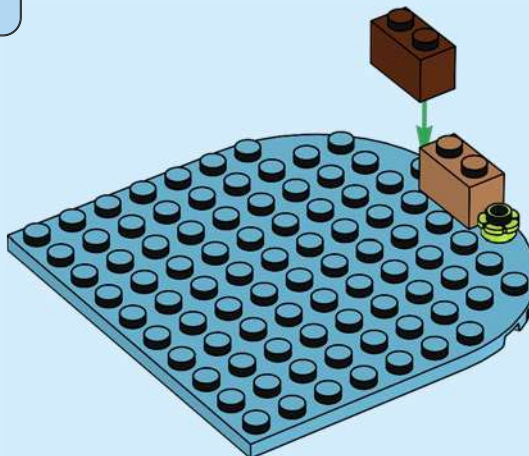

1x



1x

3

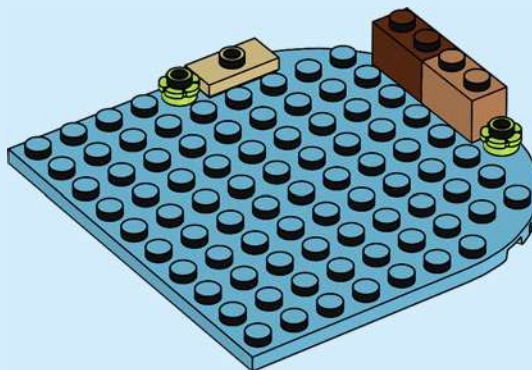

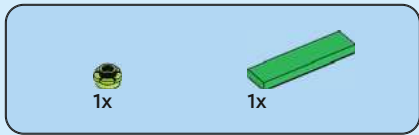

4

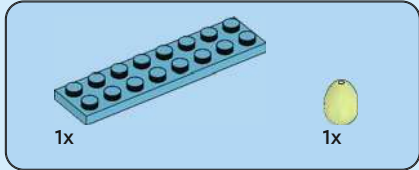
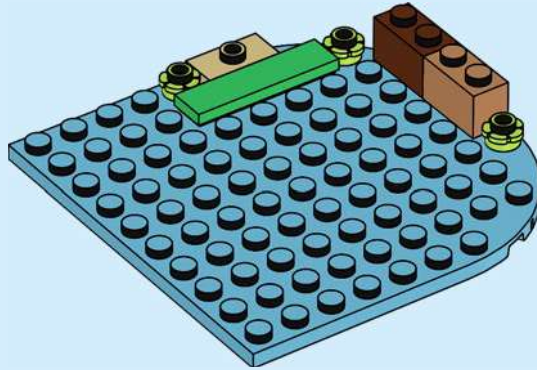

5

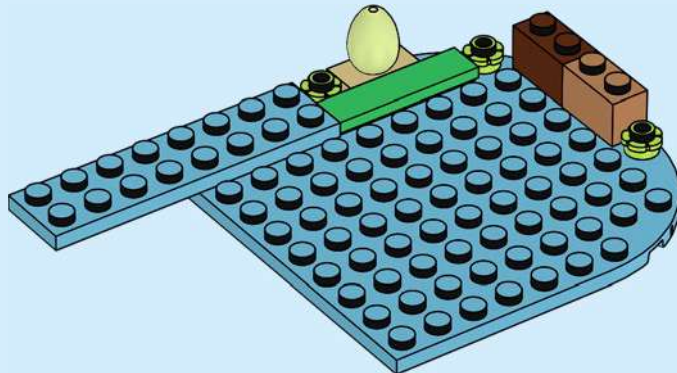



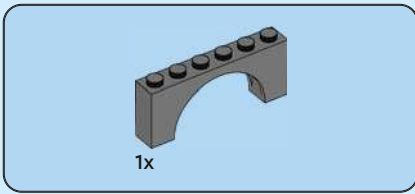

6

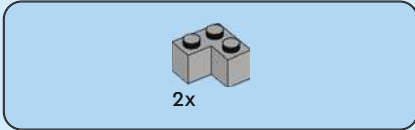
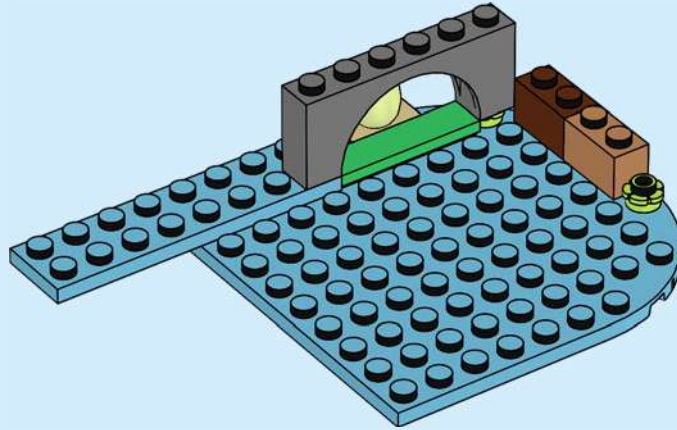

7

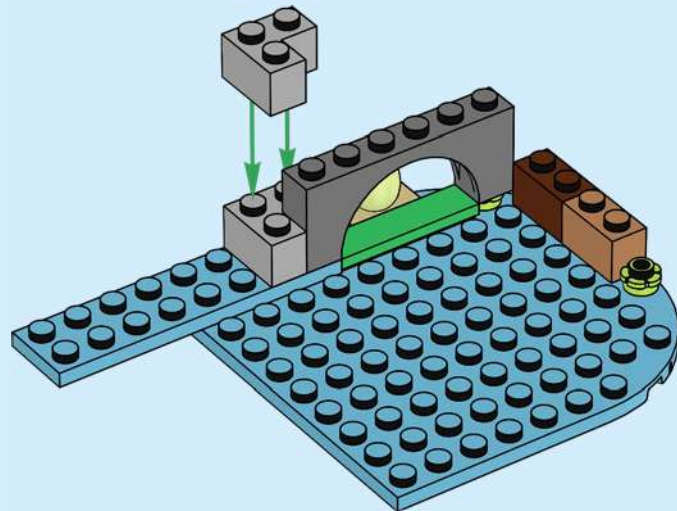

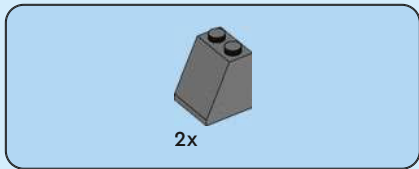

8

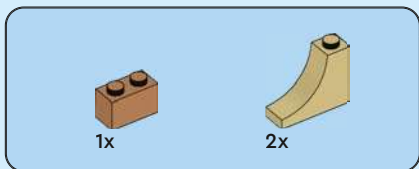
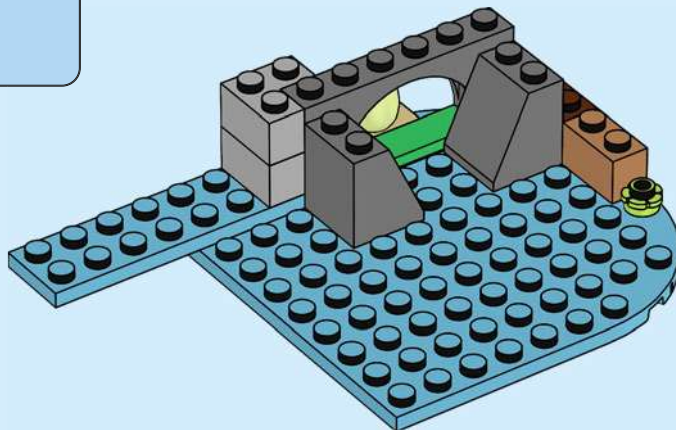

9





10

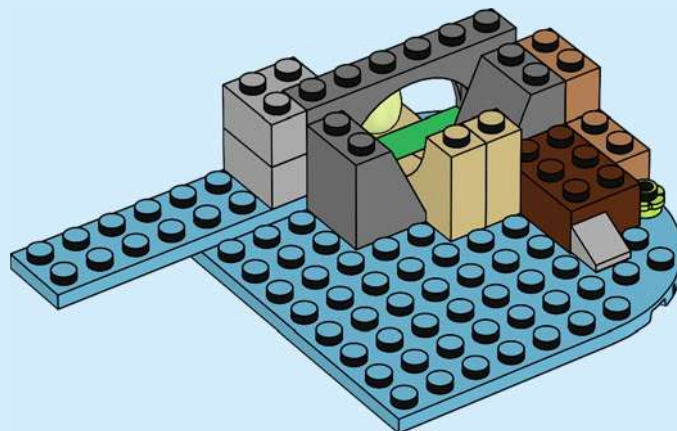

11

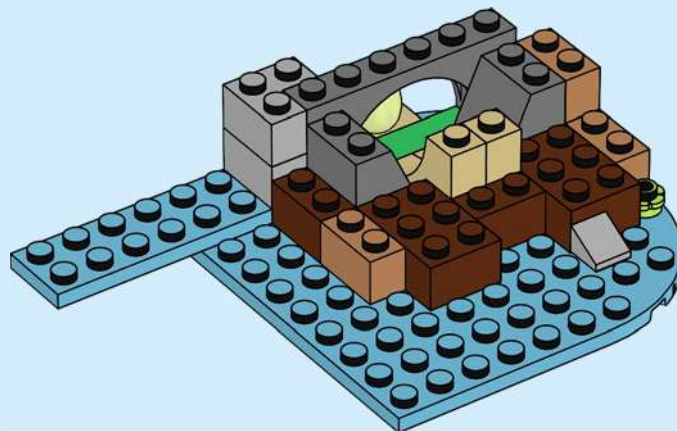

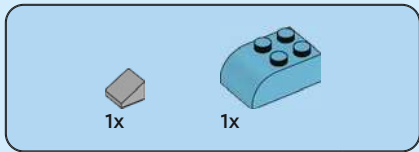

12

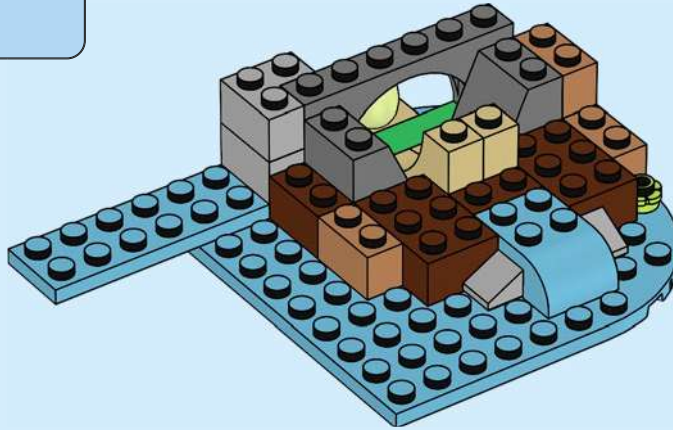

13

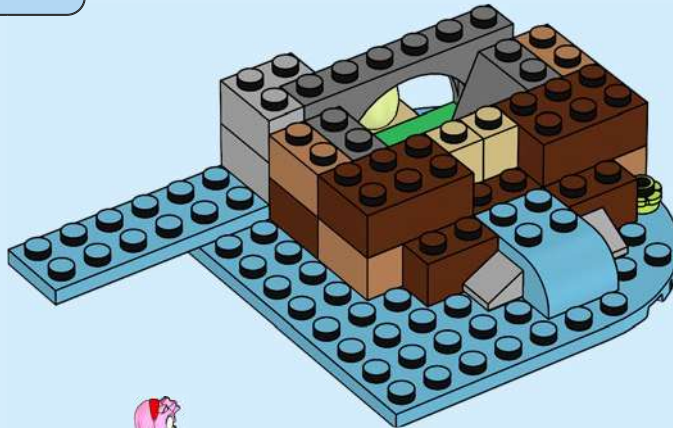

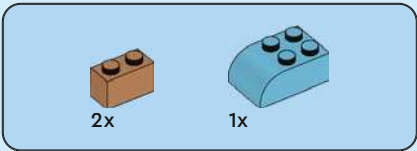

14

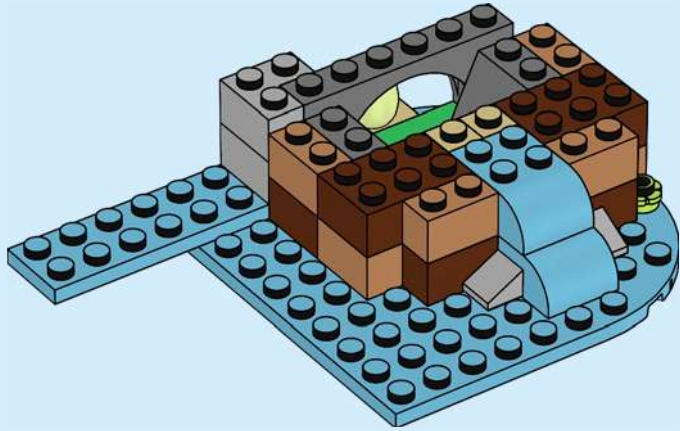

15

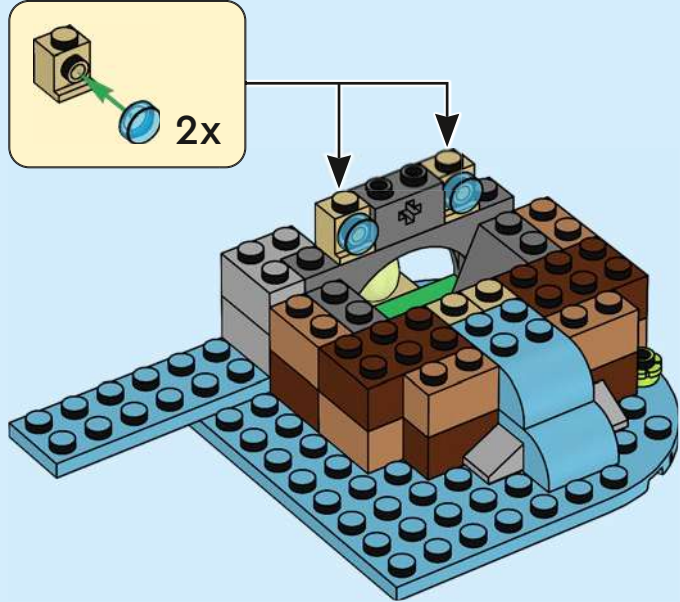



2x



1x

16



2x

17



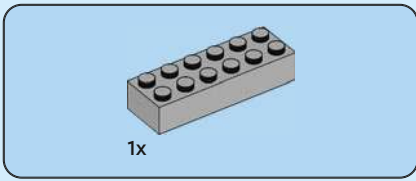

18





19

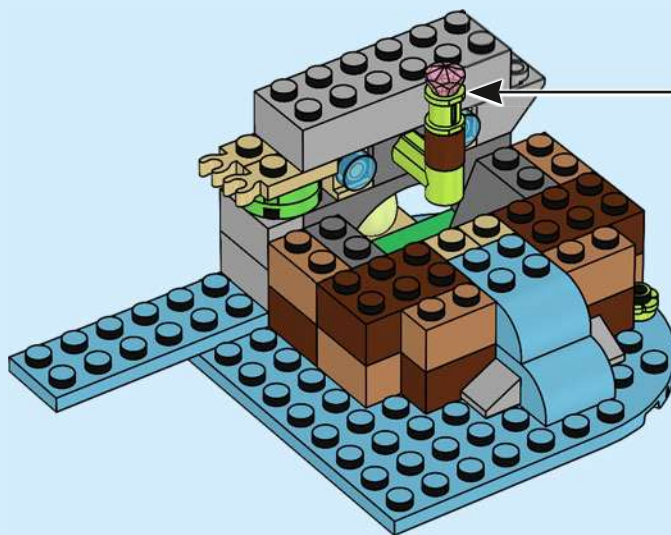
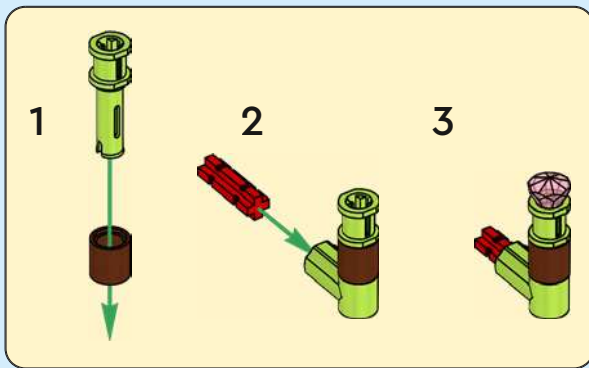





1x



1x

20

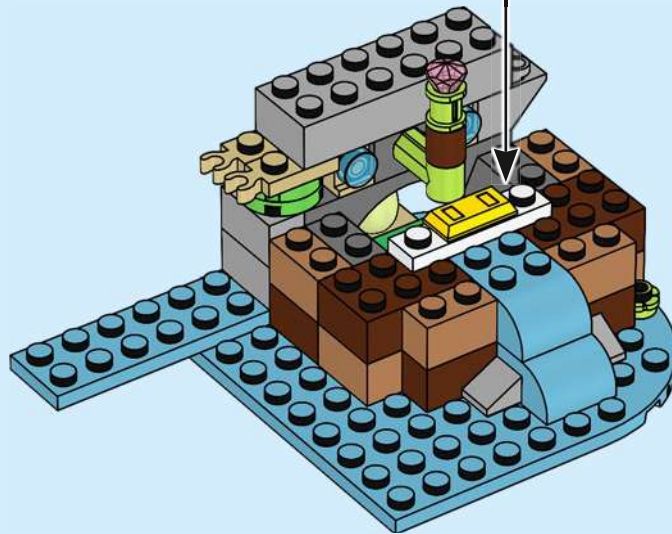
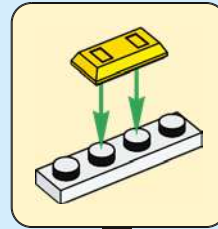

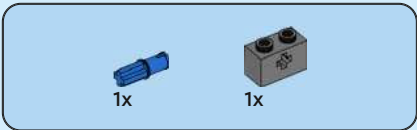

21

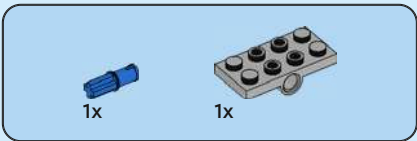
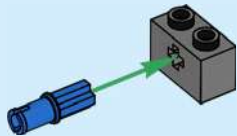

22

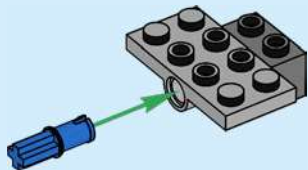

23

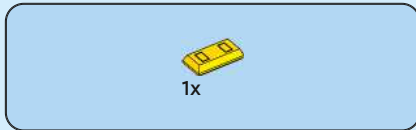

24



25

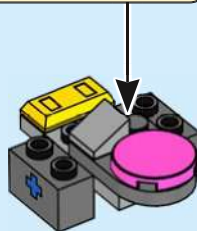

26

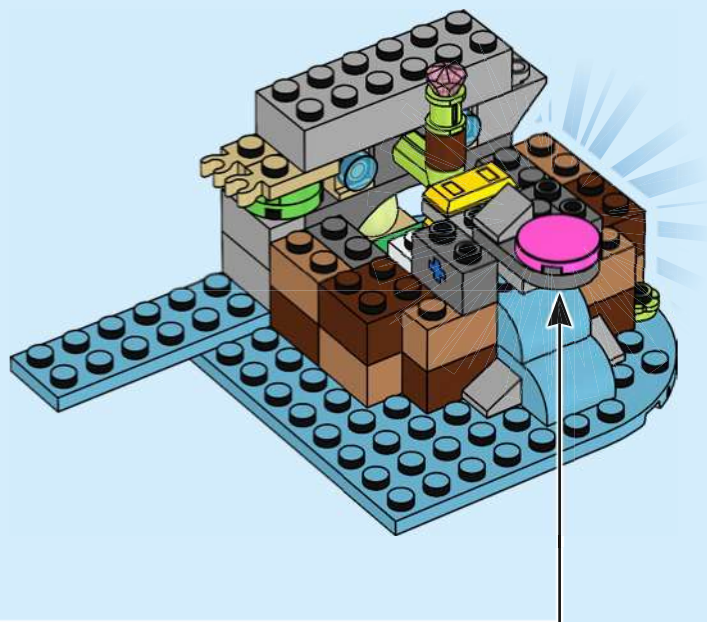



2x

27

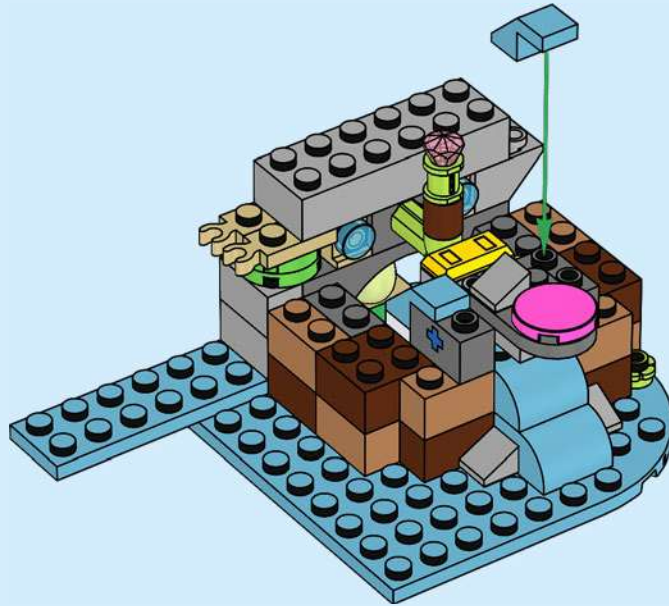

2x

28

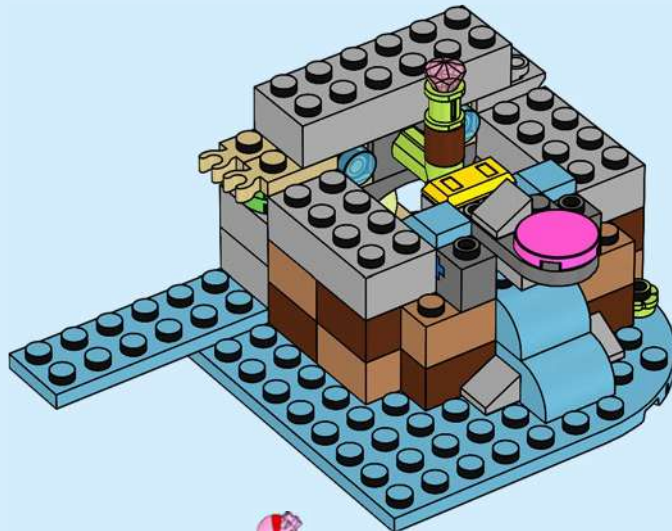



4x

29



2x

30

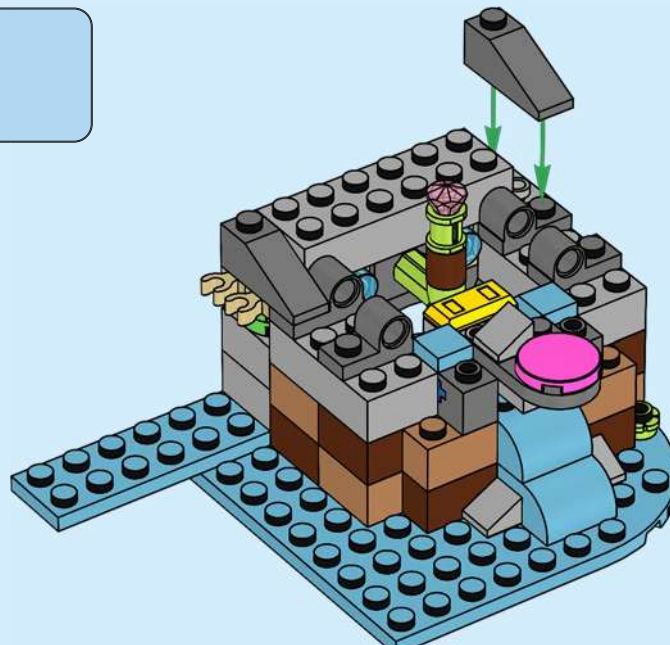

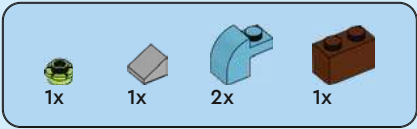

31

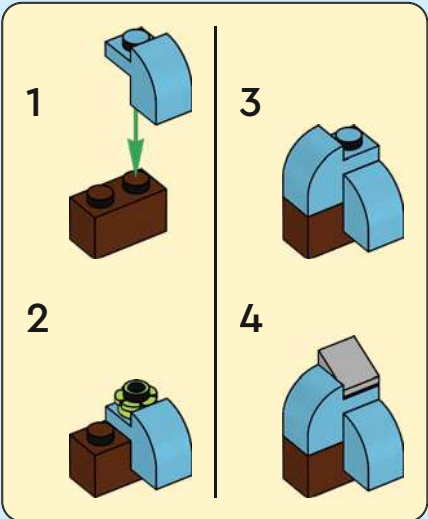

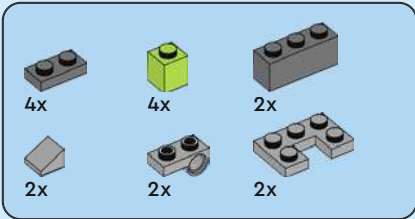

32

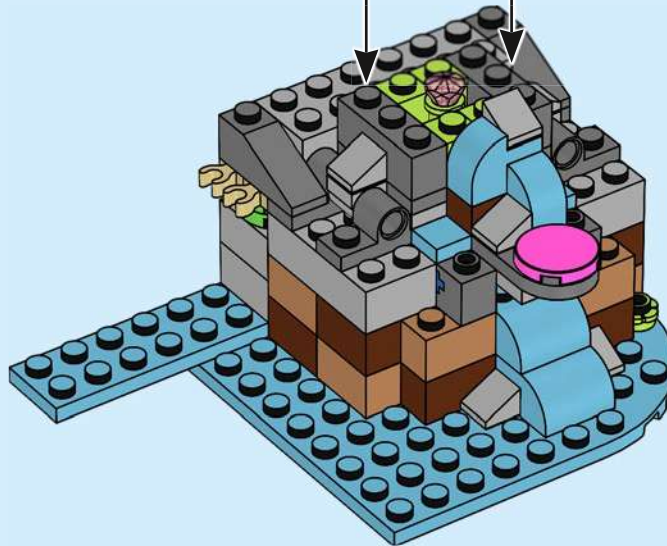
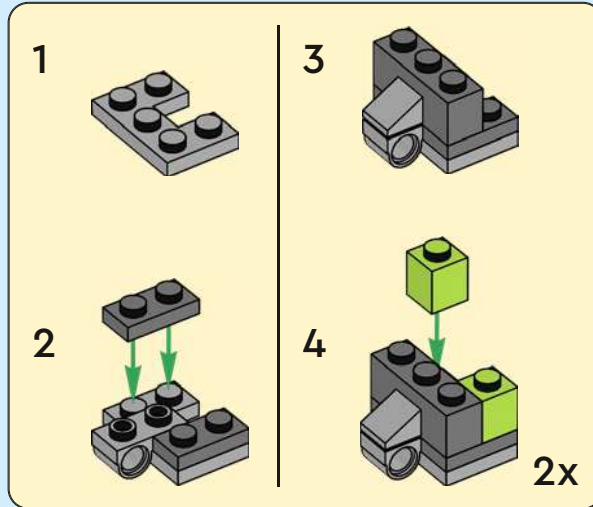

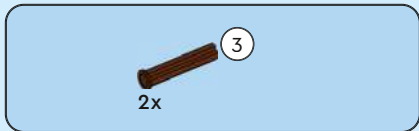

33

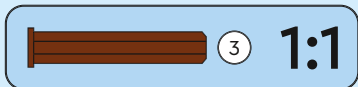
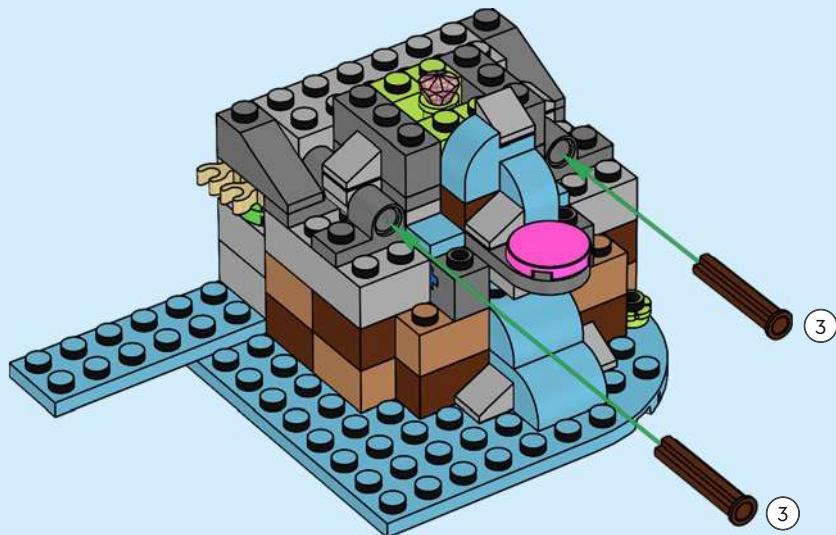





2x

34

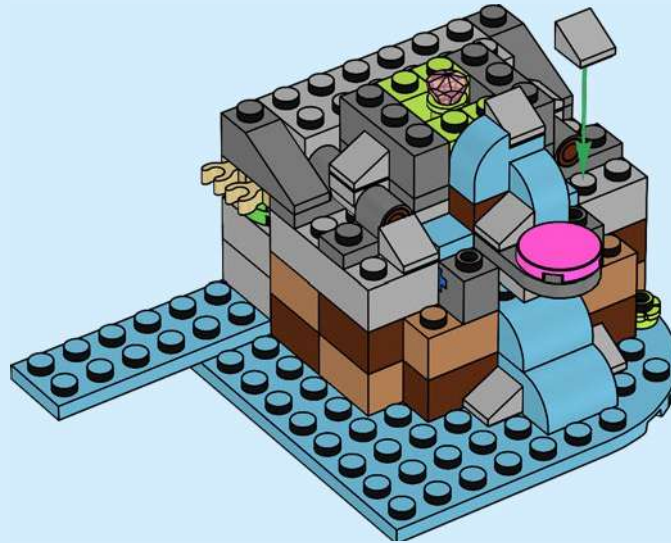



1x



1x

35



2x



1x

36





2x

37

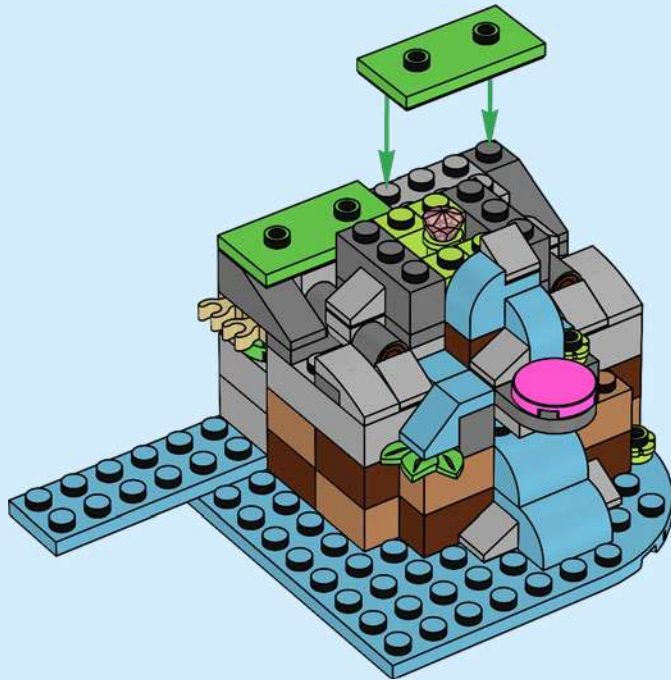



38

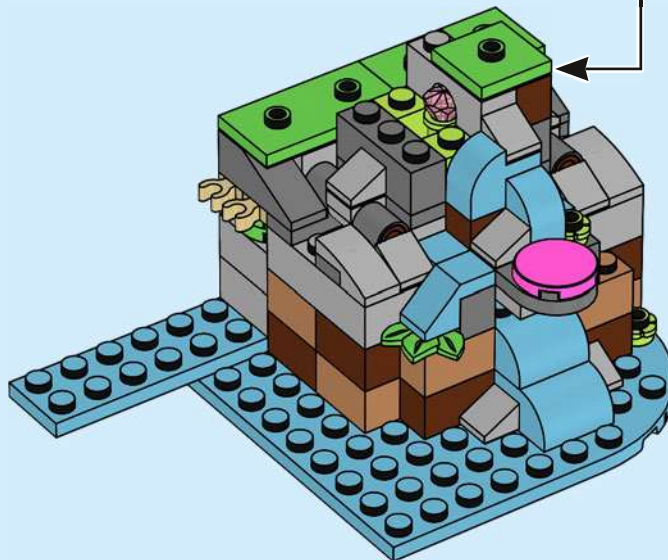
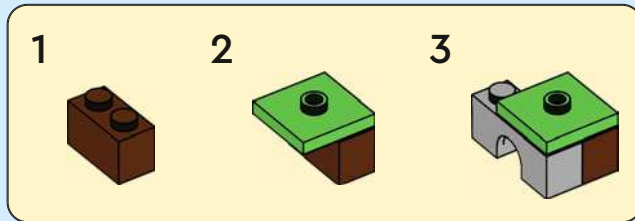



39

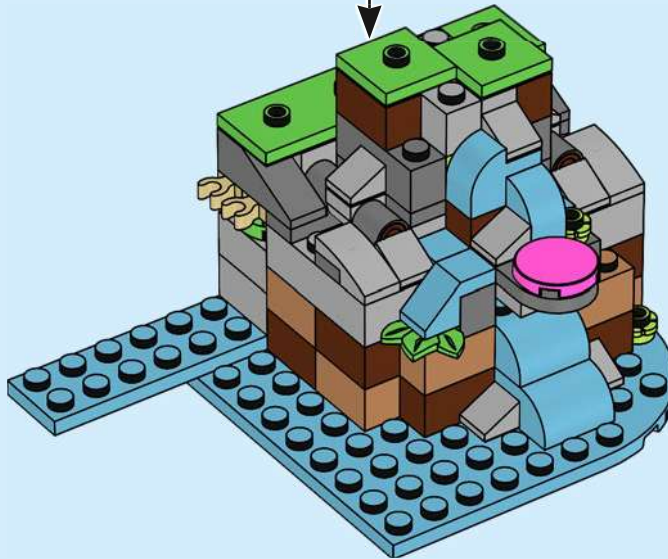
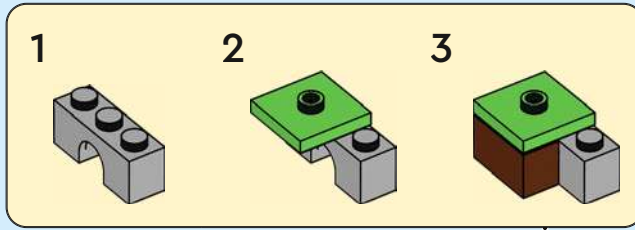

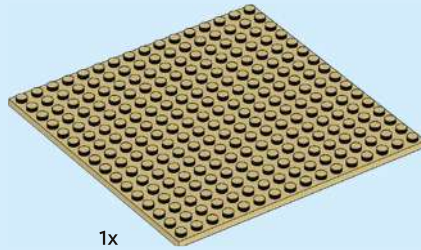
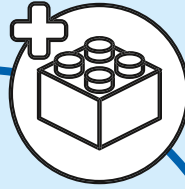

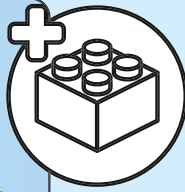
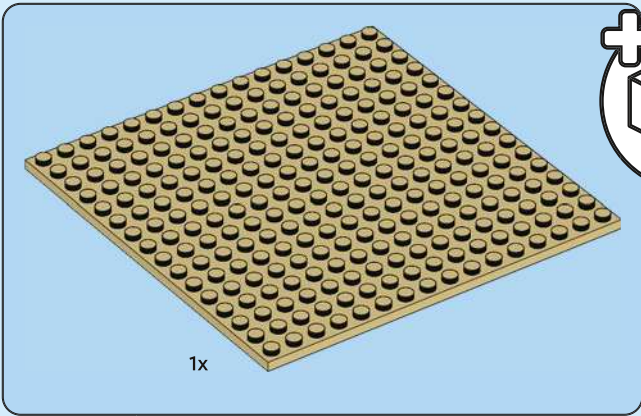

40

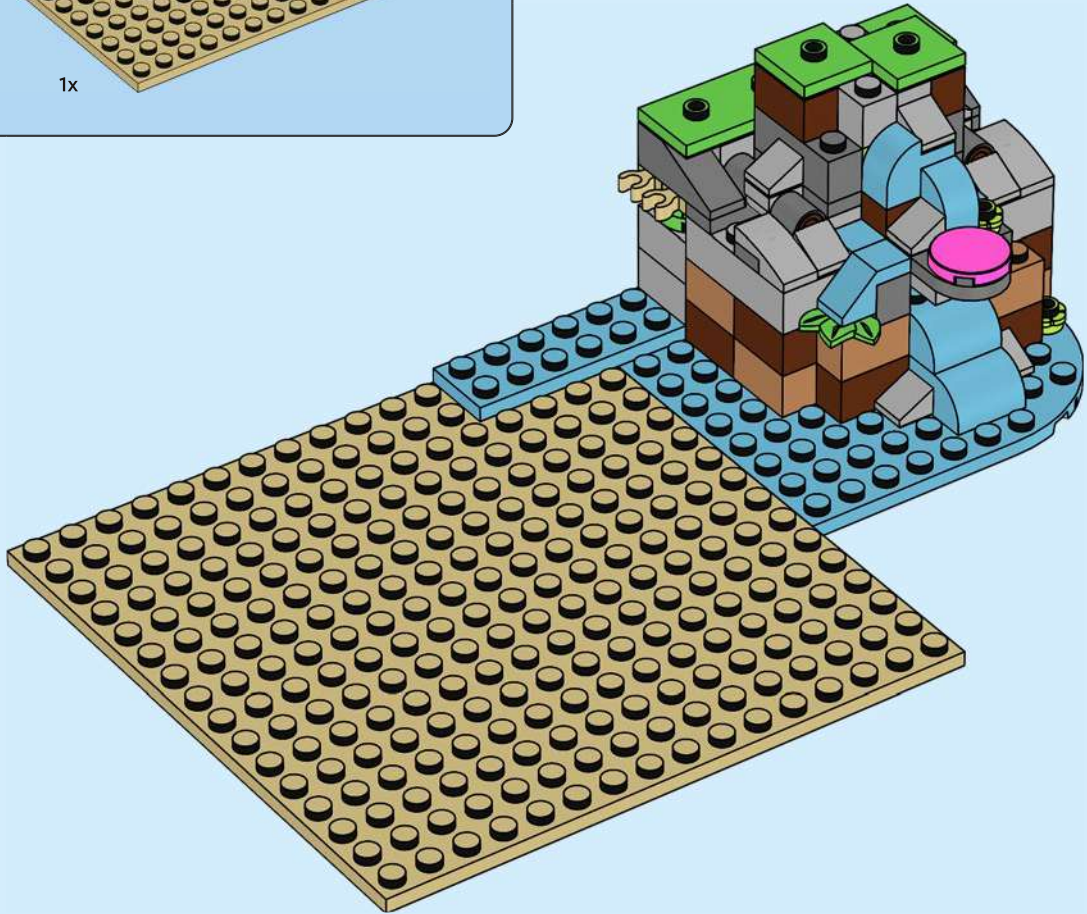



3x

41

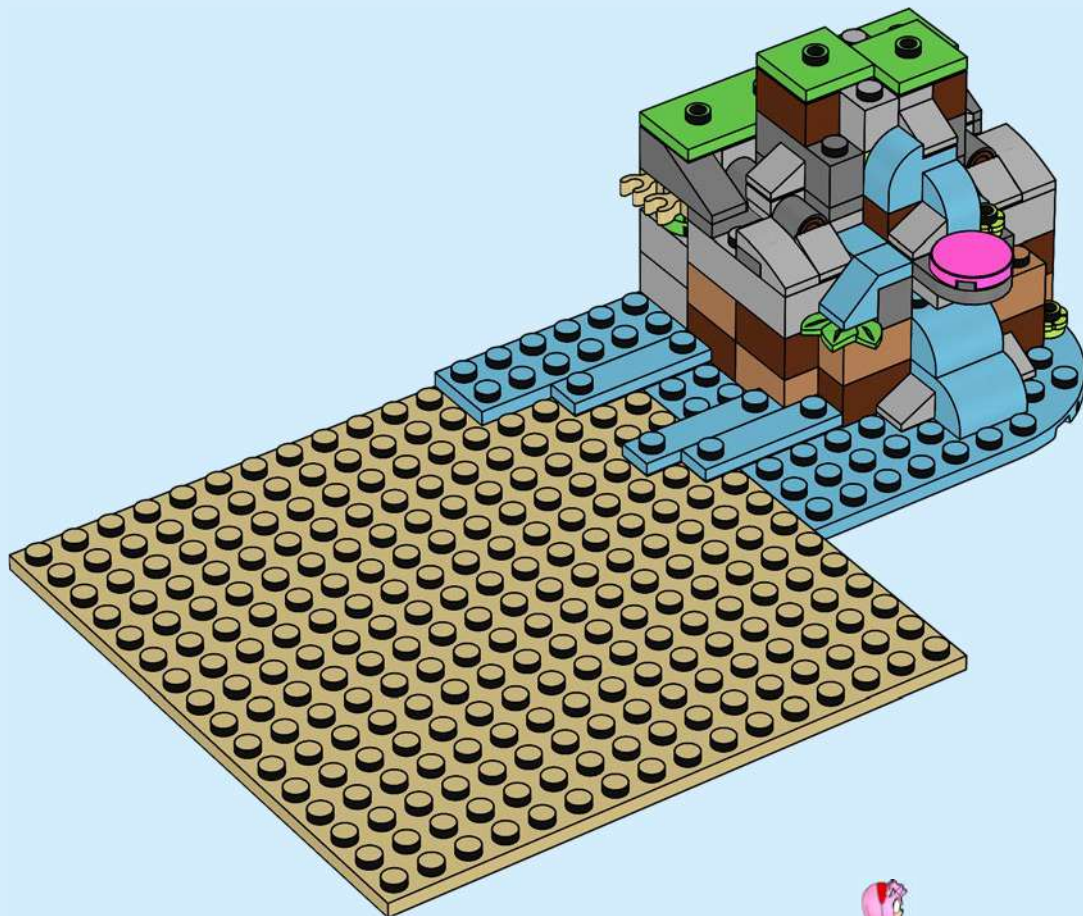





42

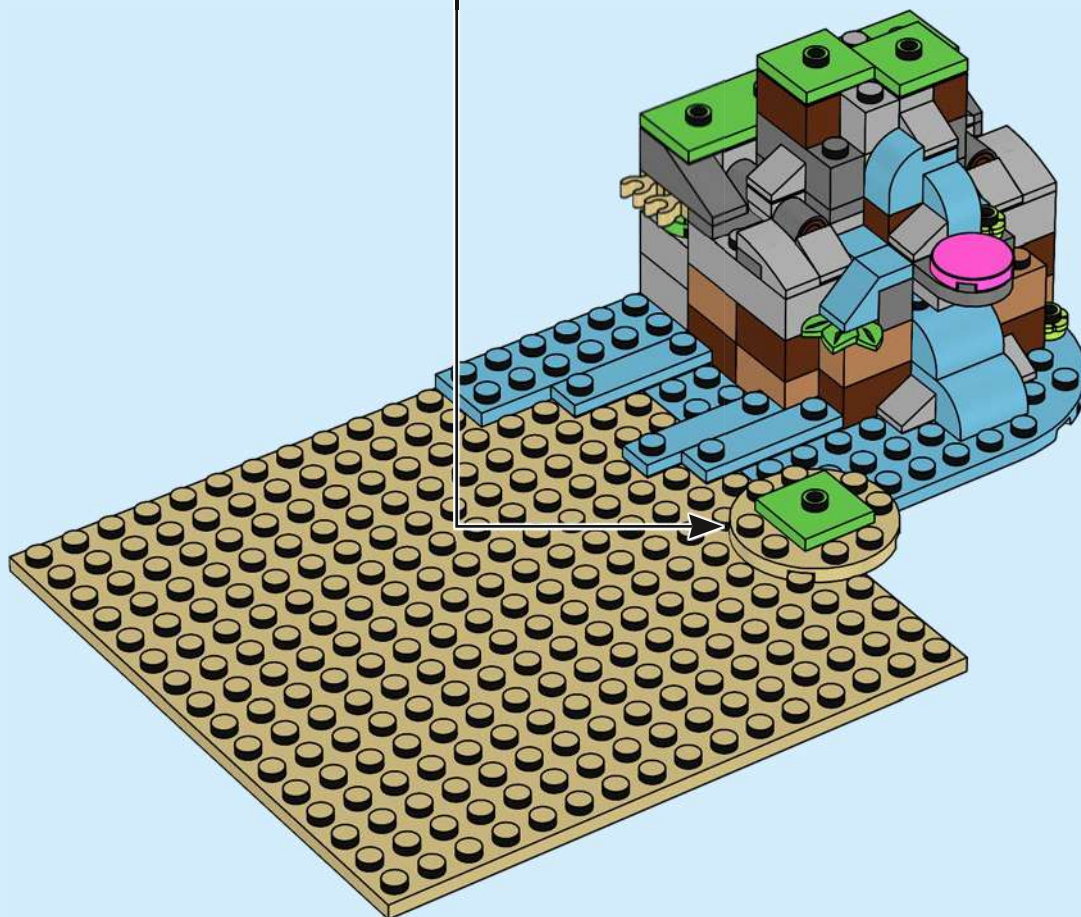
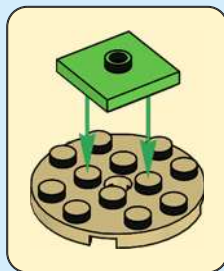

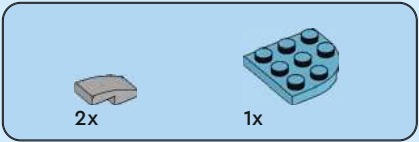

43

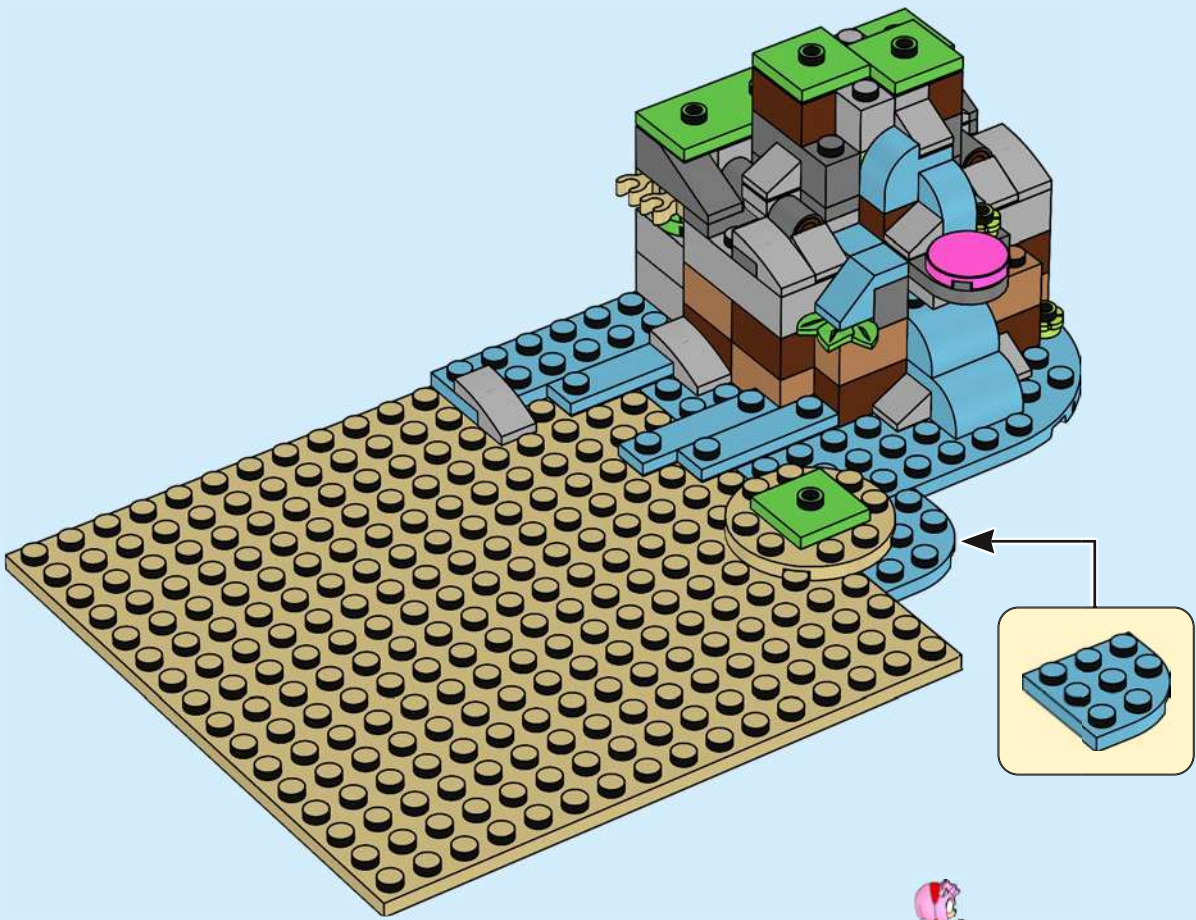

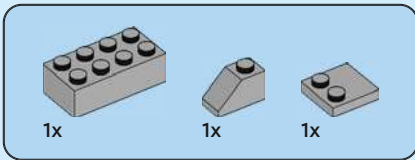

44

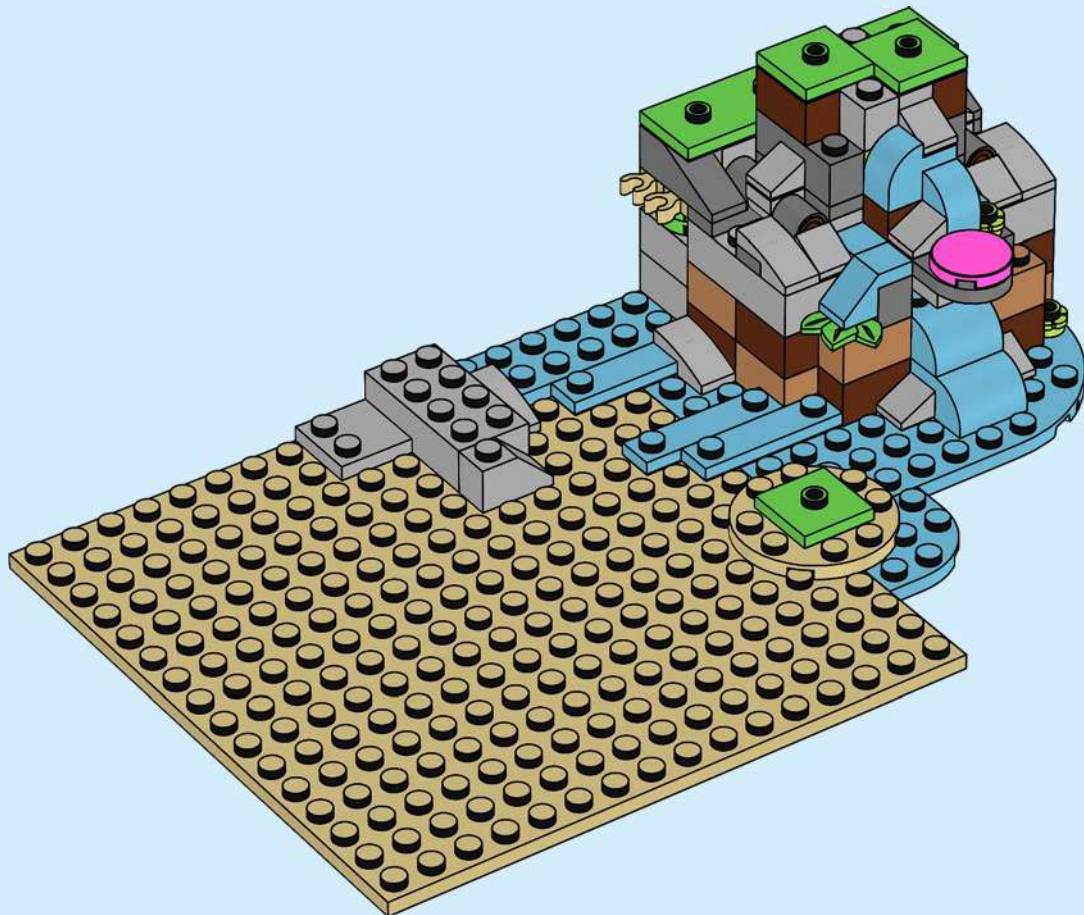





46

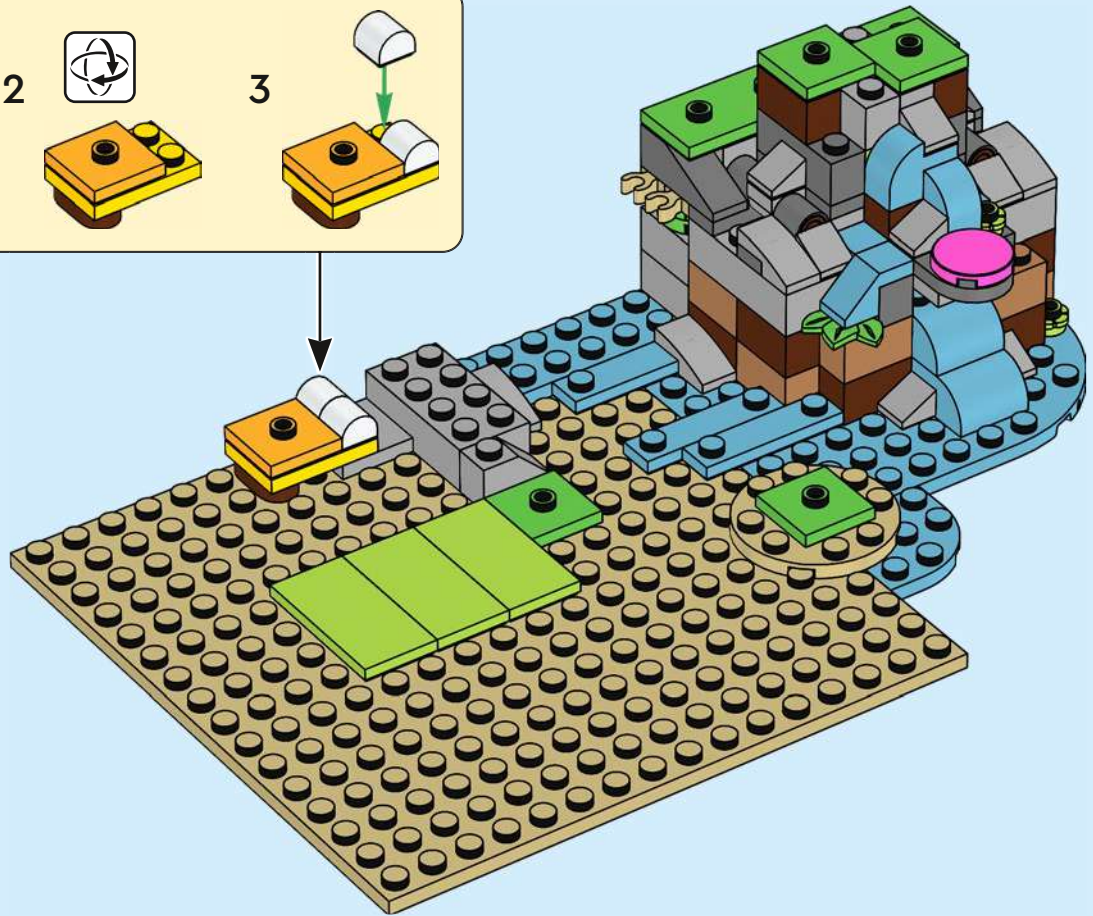
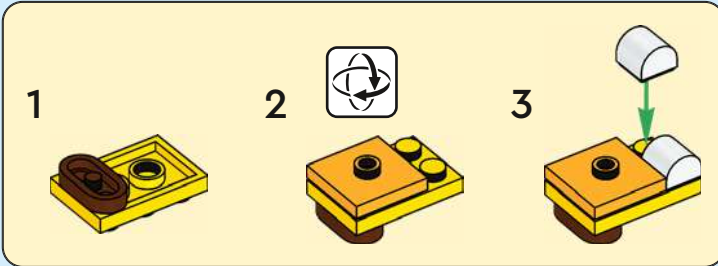

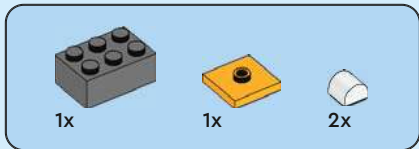

47

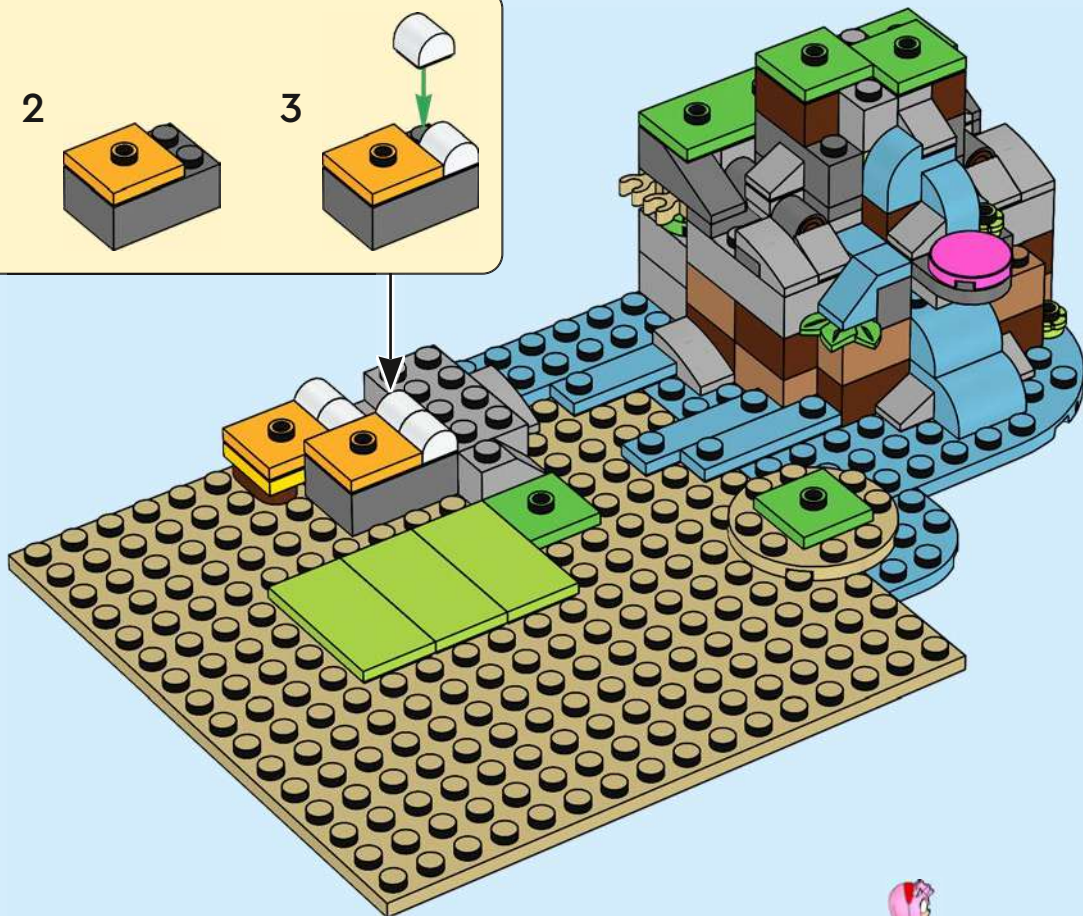
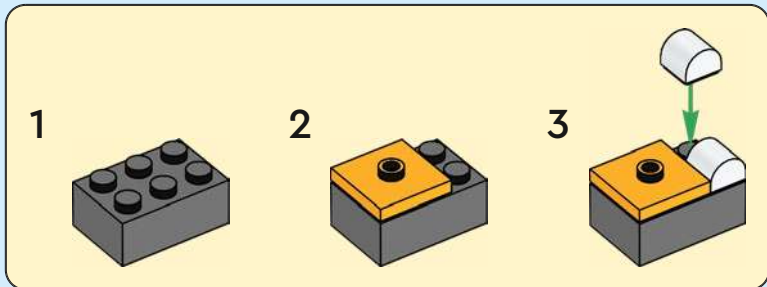



1x



1x

# 48

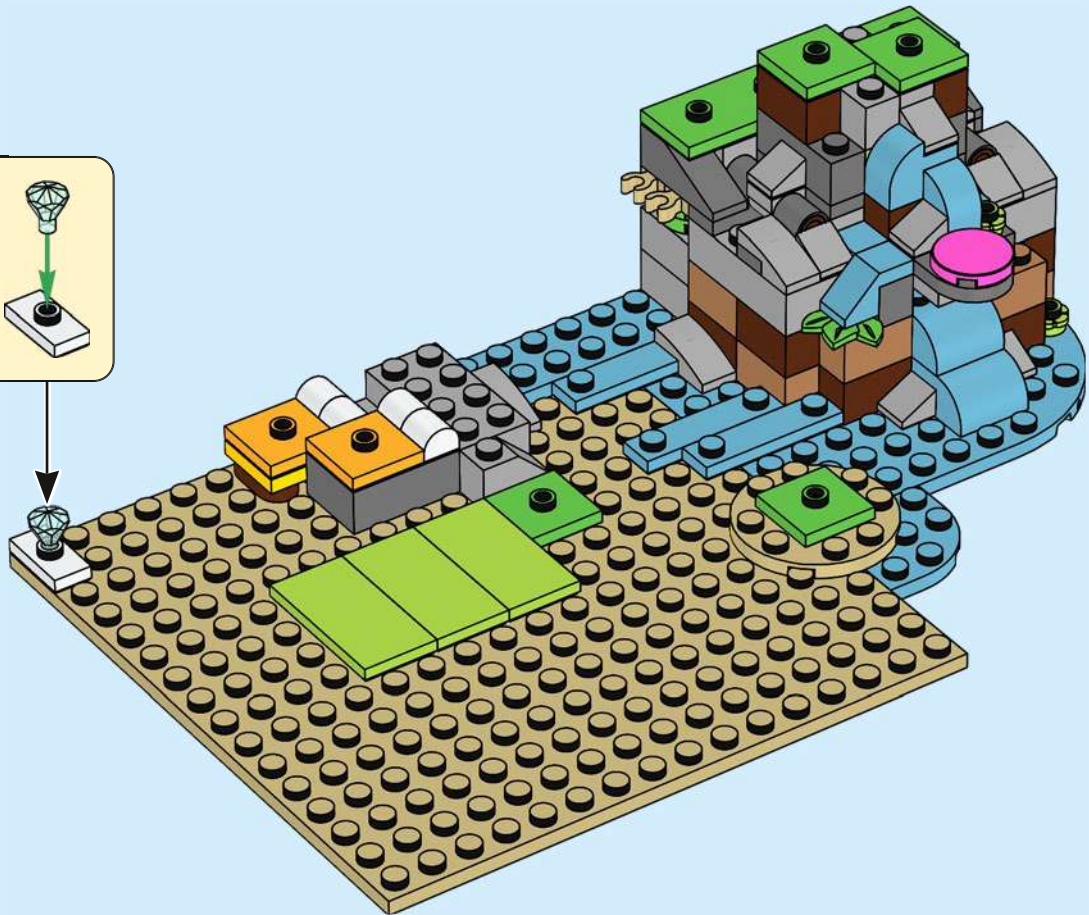
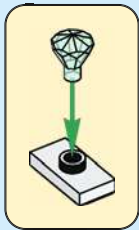

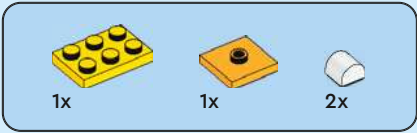

# 49

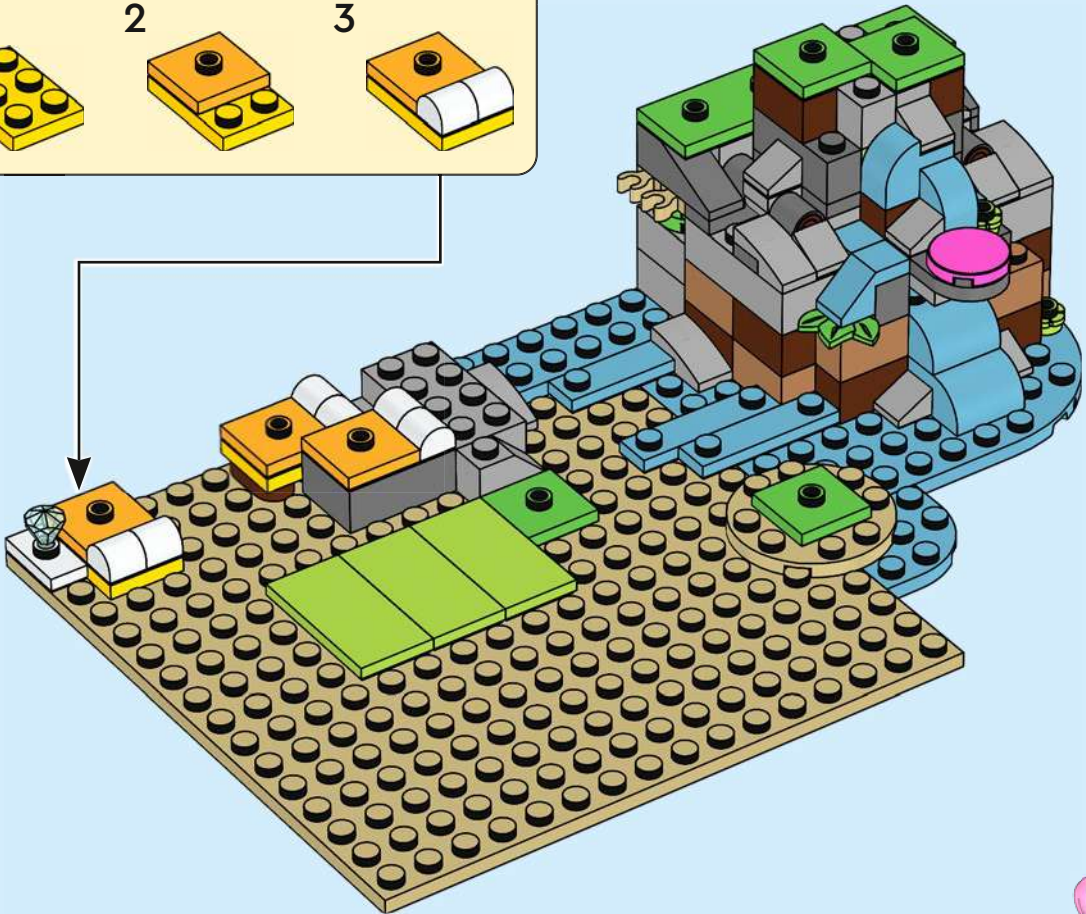
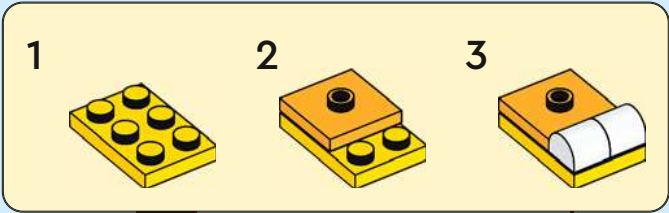





1x



1x

50

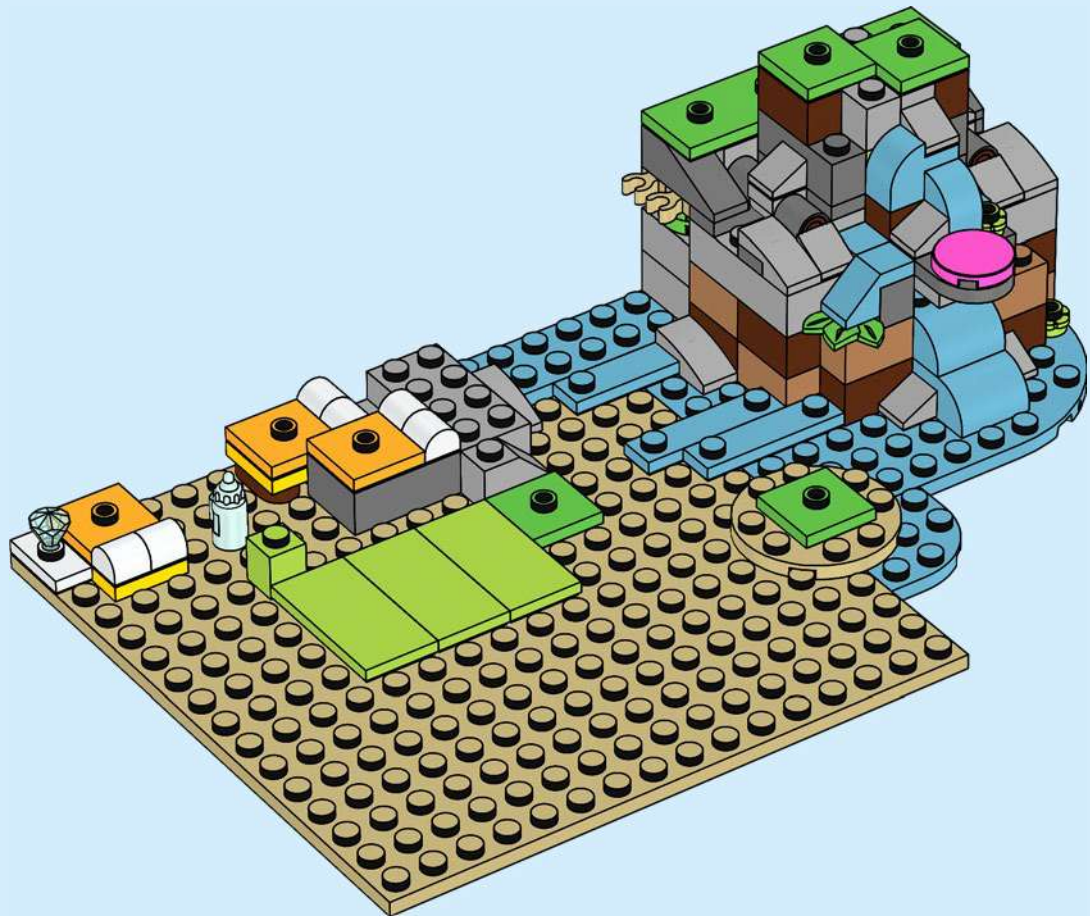



2x

51

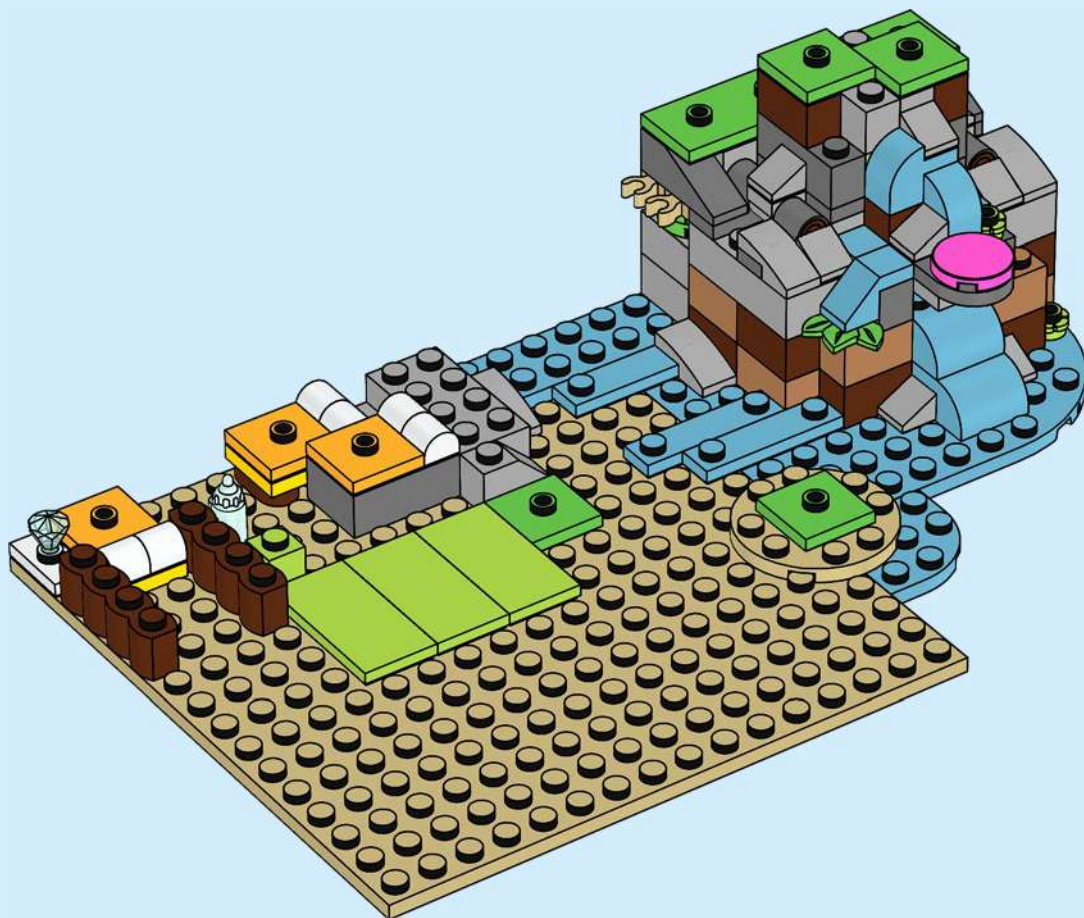

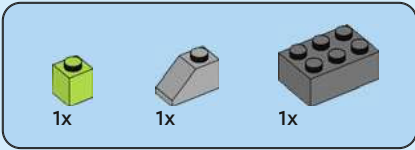

52

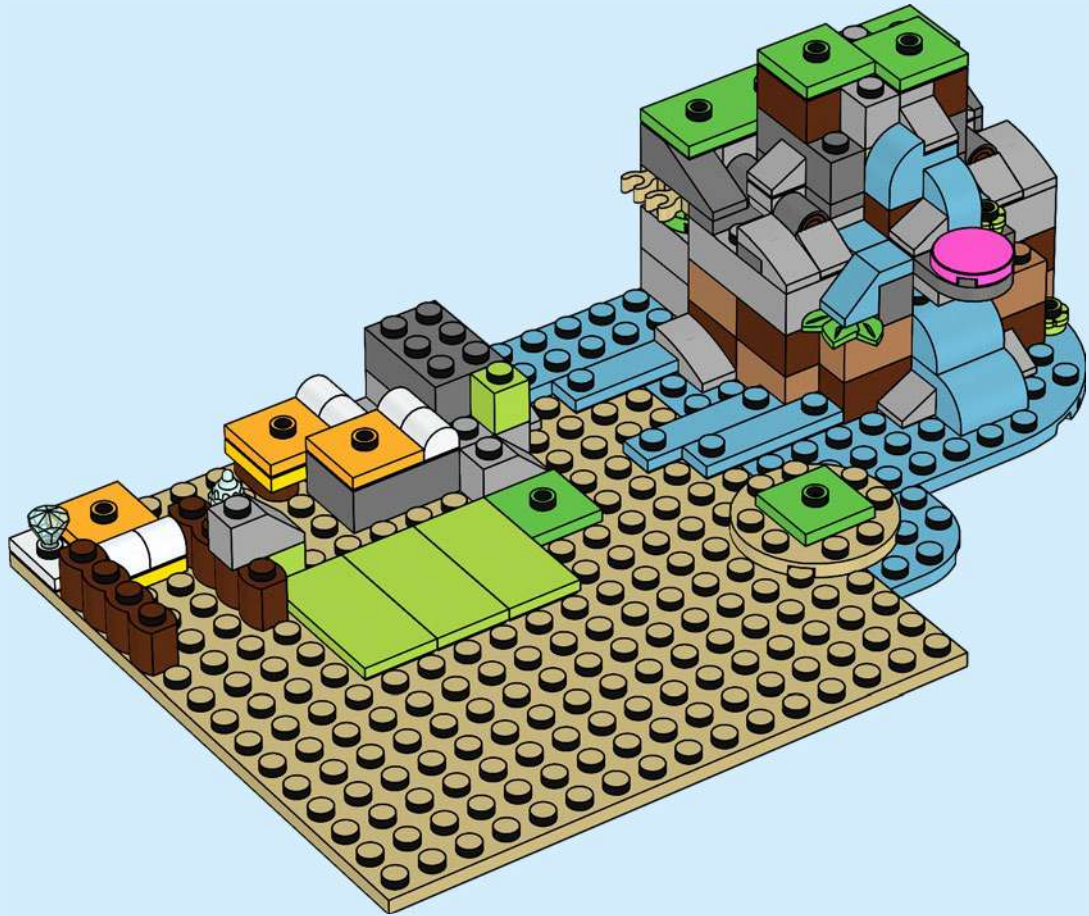

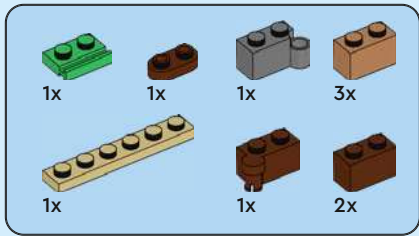

53

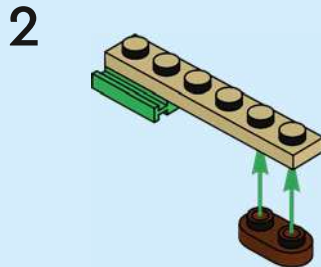
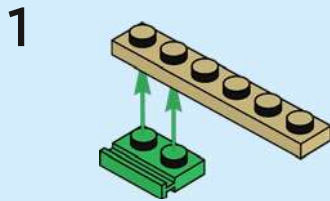

3

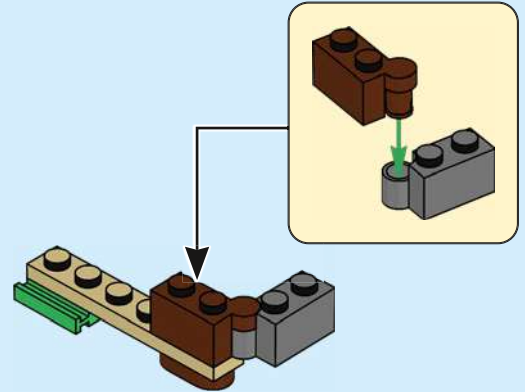

4

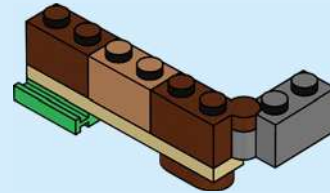

5

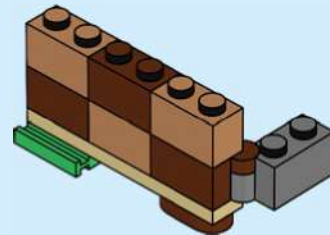



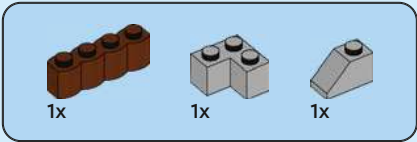

# 54

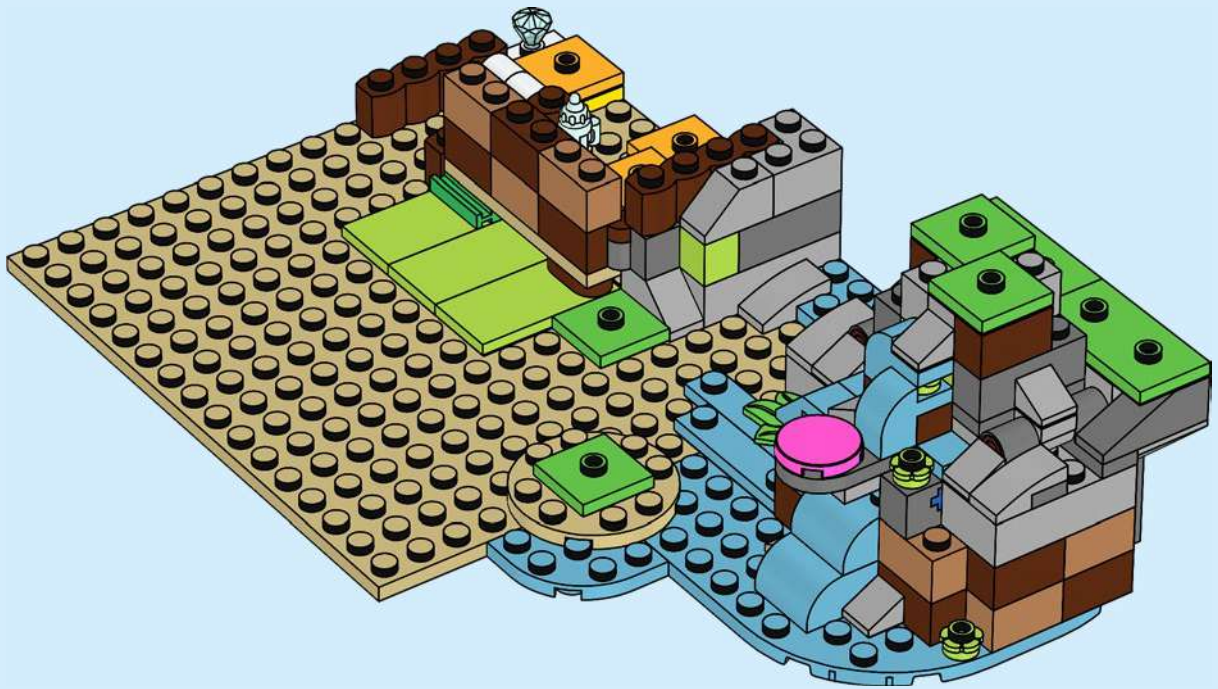

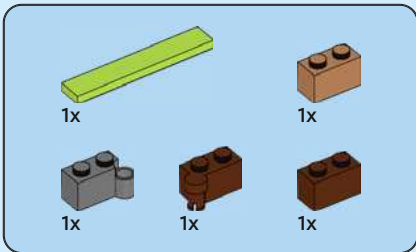

55

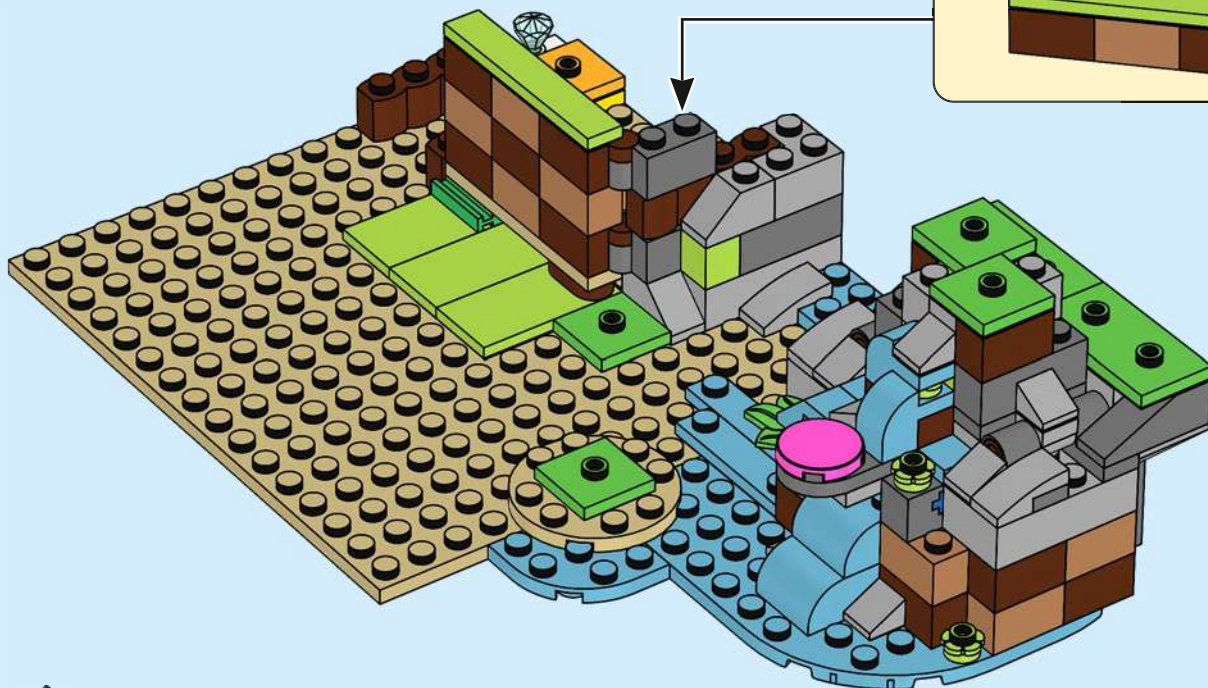
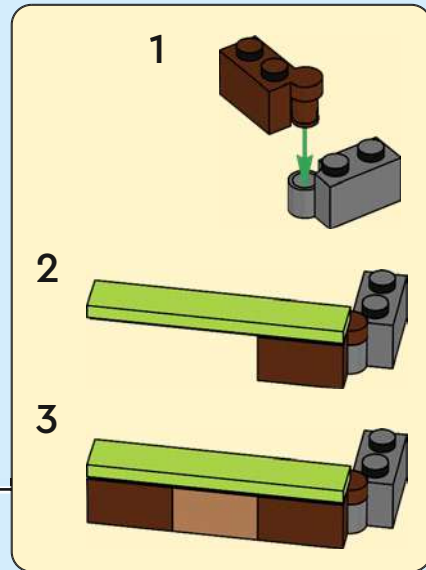

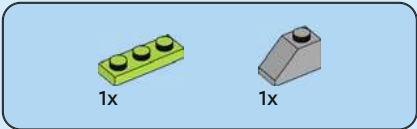

# 56





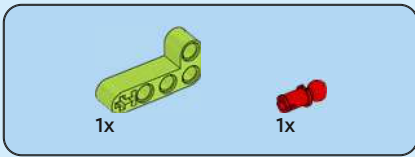

57

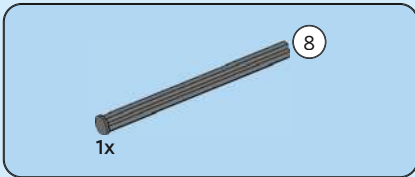
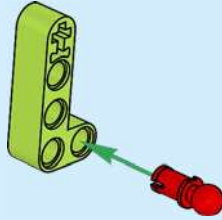

58

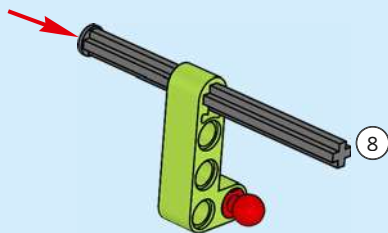

59

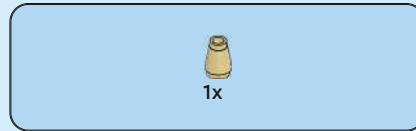
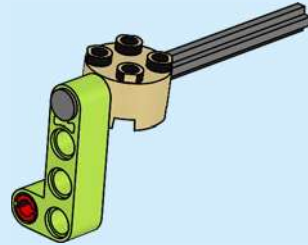

60

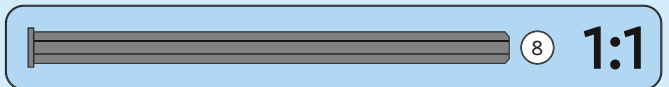
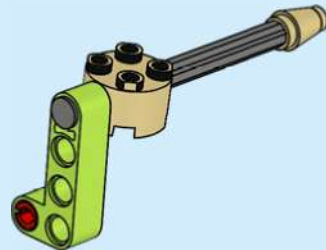

61

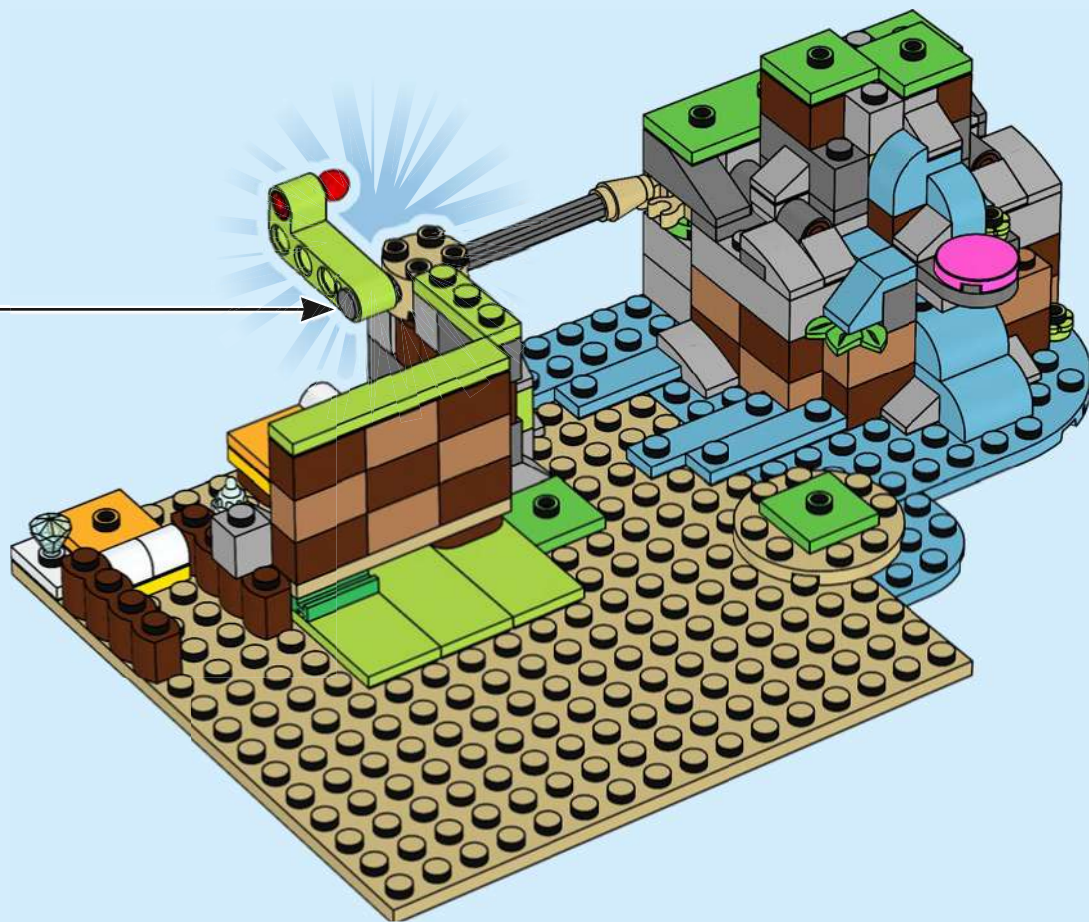



2x

62

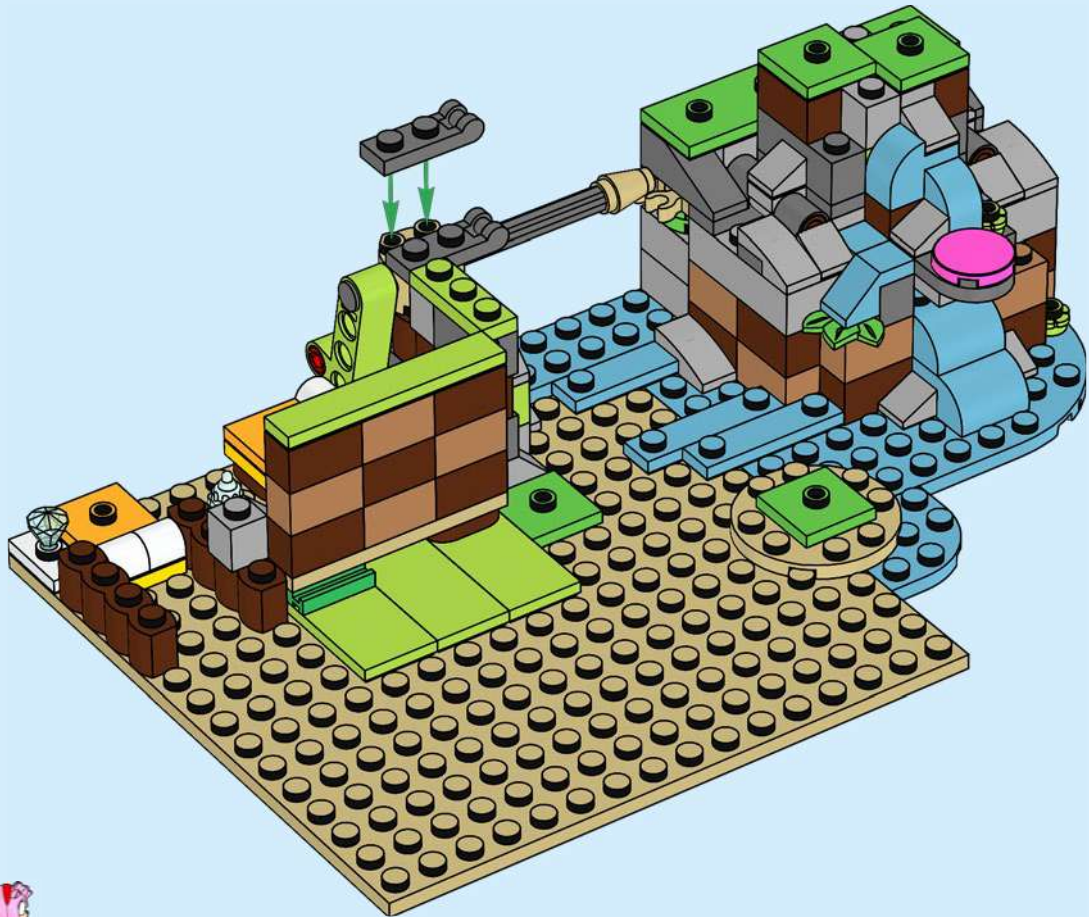



3x

63

1

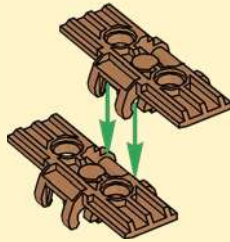

2

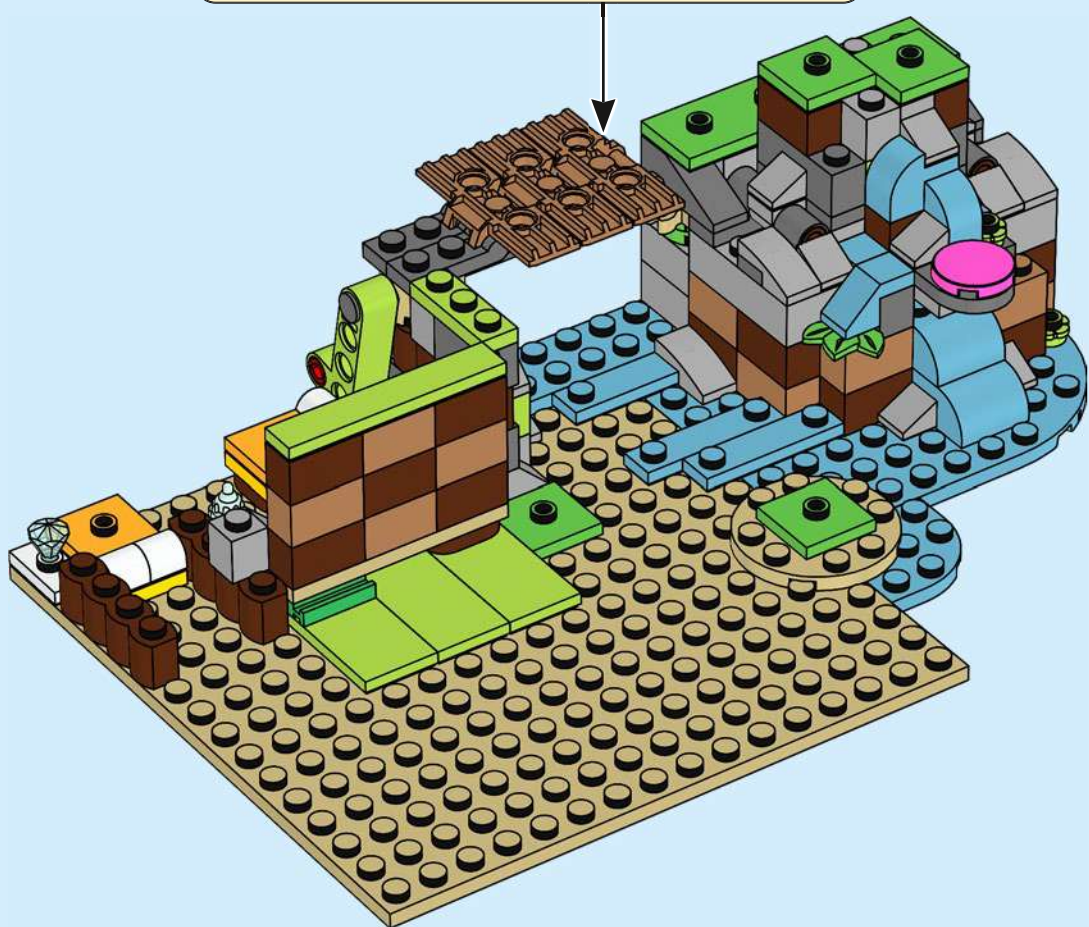

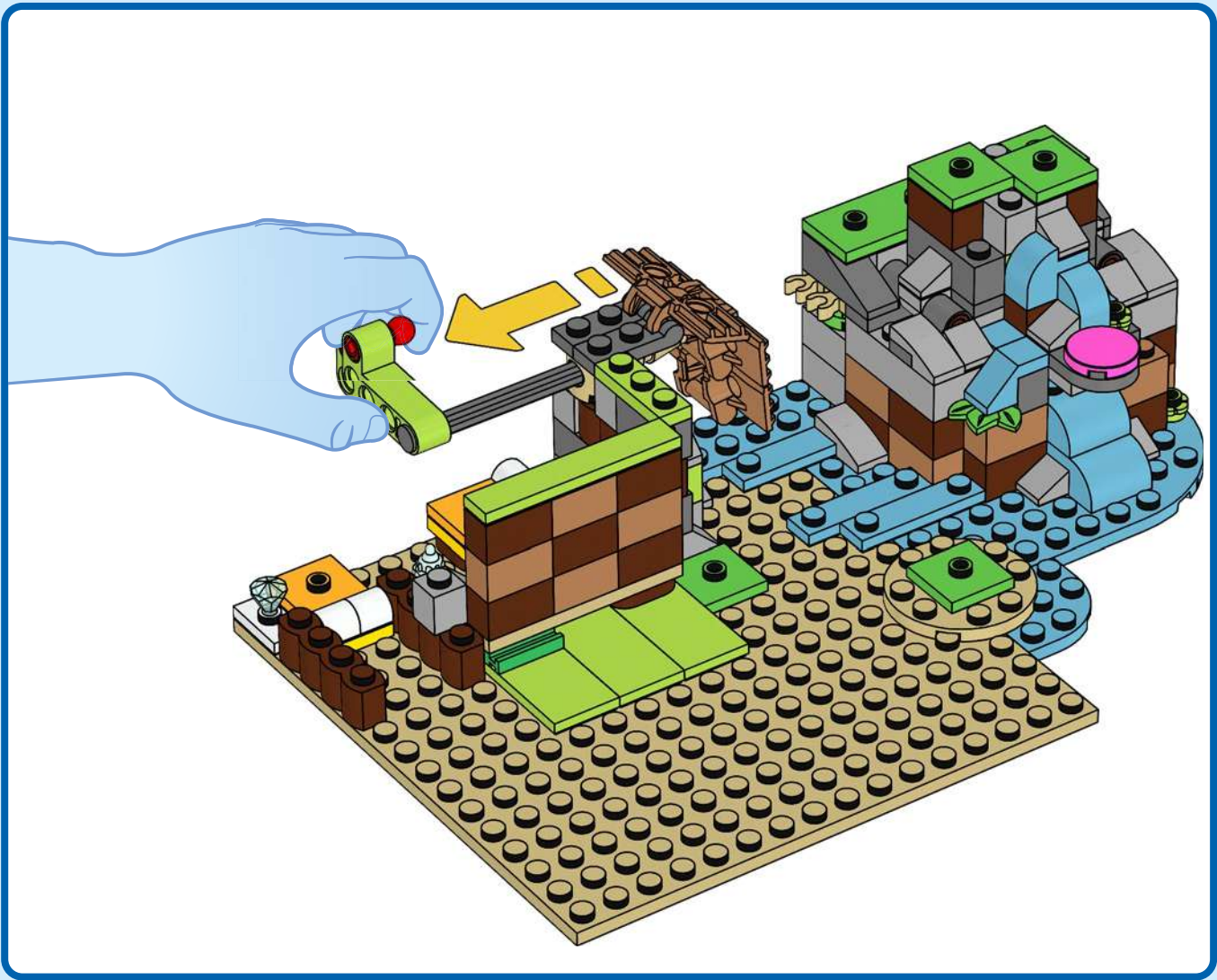

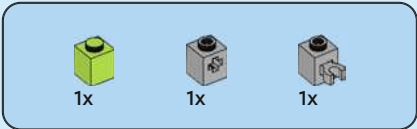

64

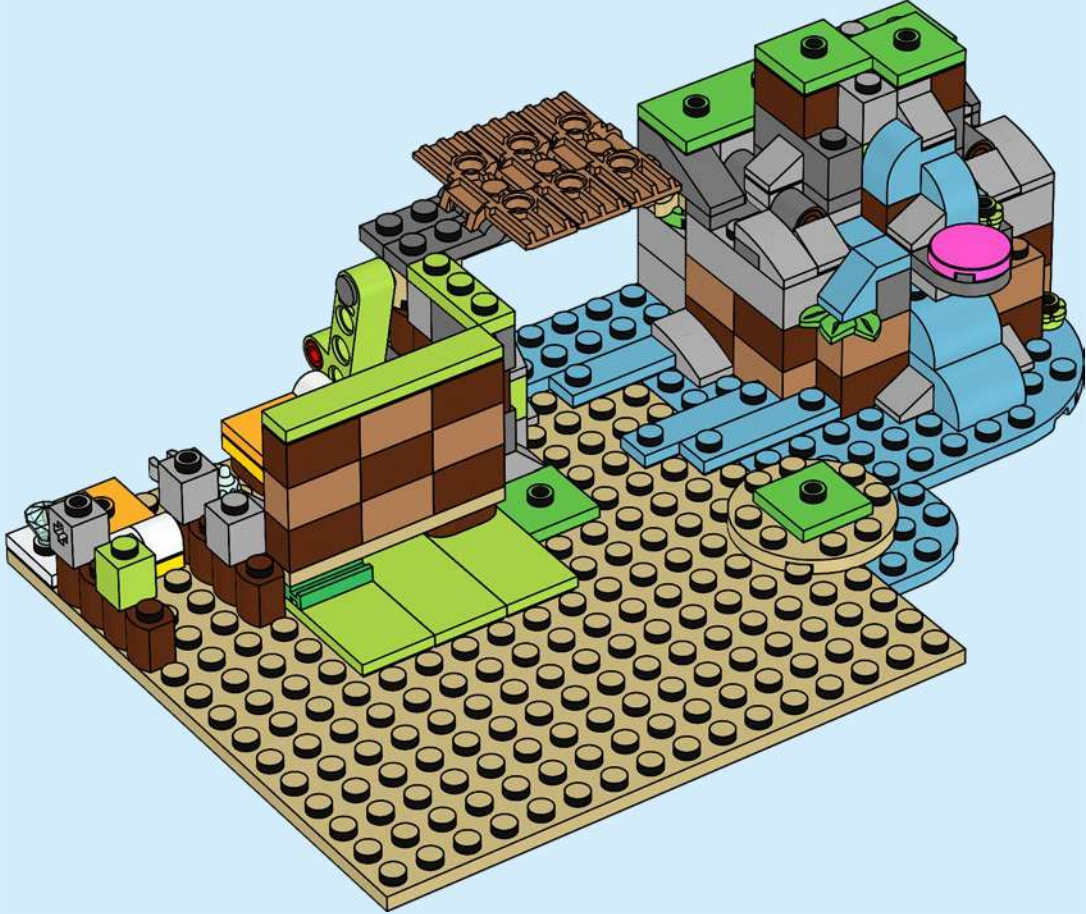

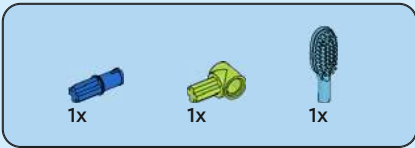

65

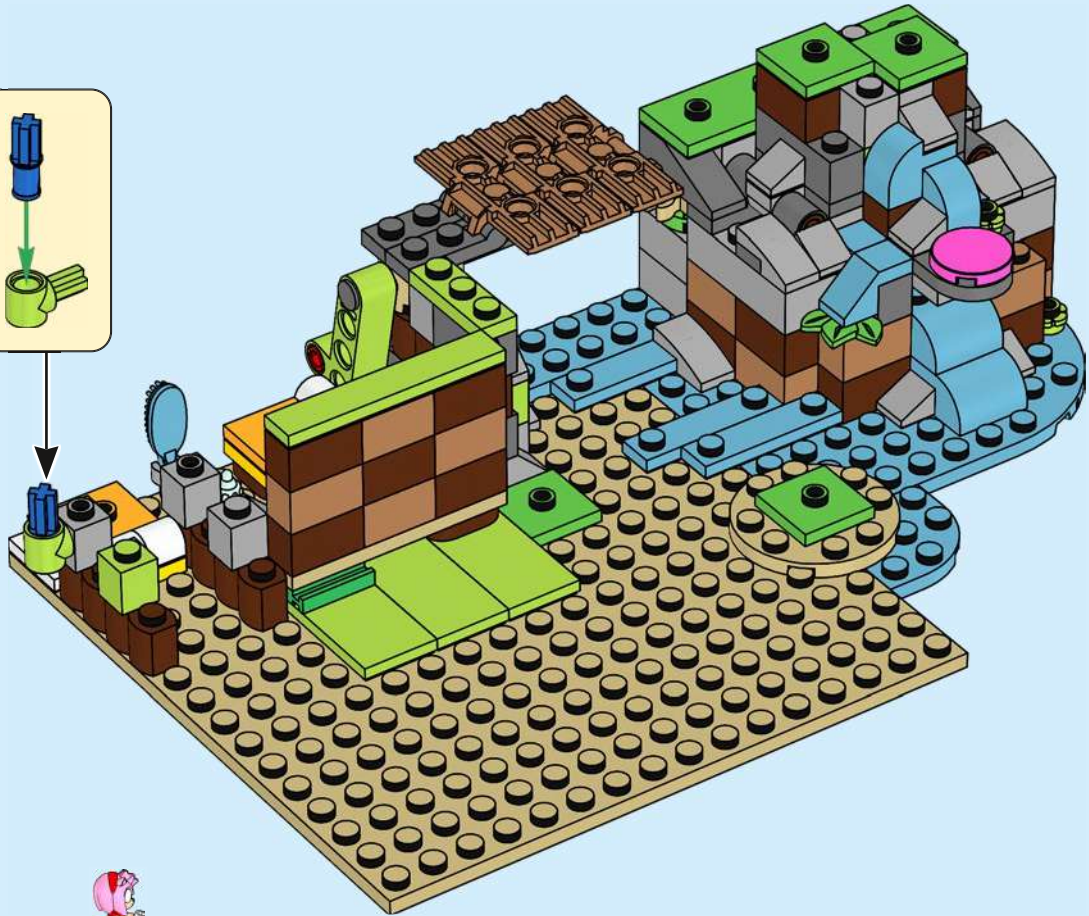
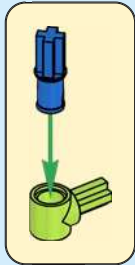



1x

66

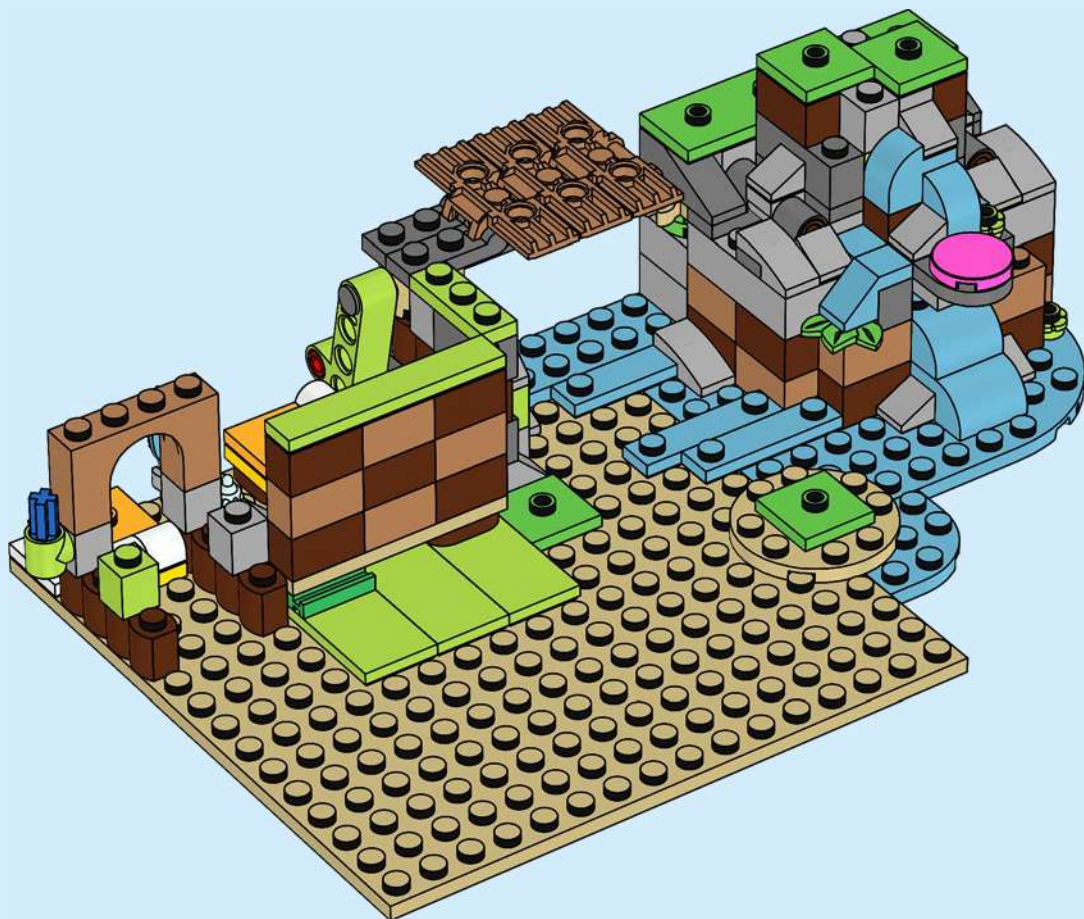



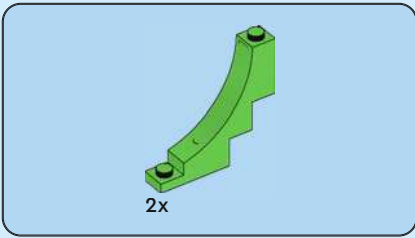

67

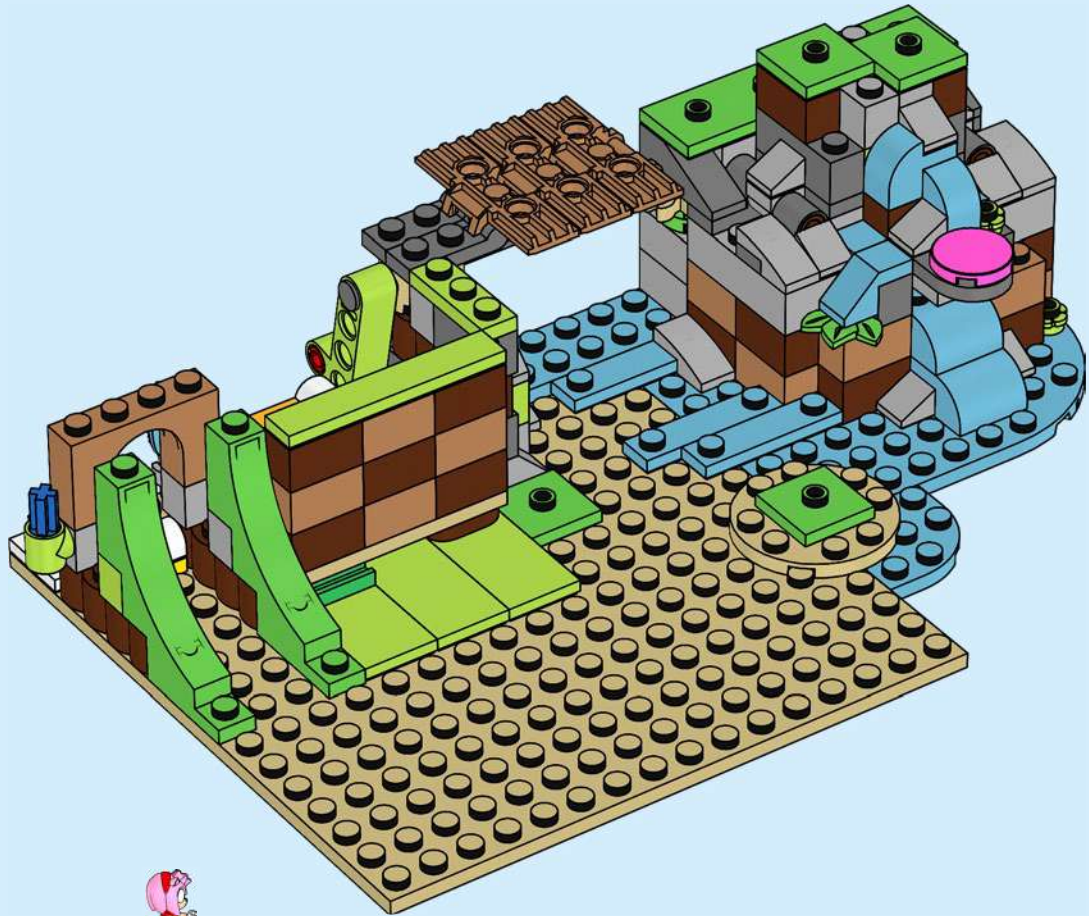



1x



1x

68

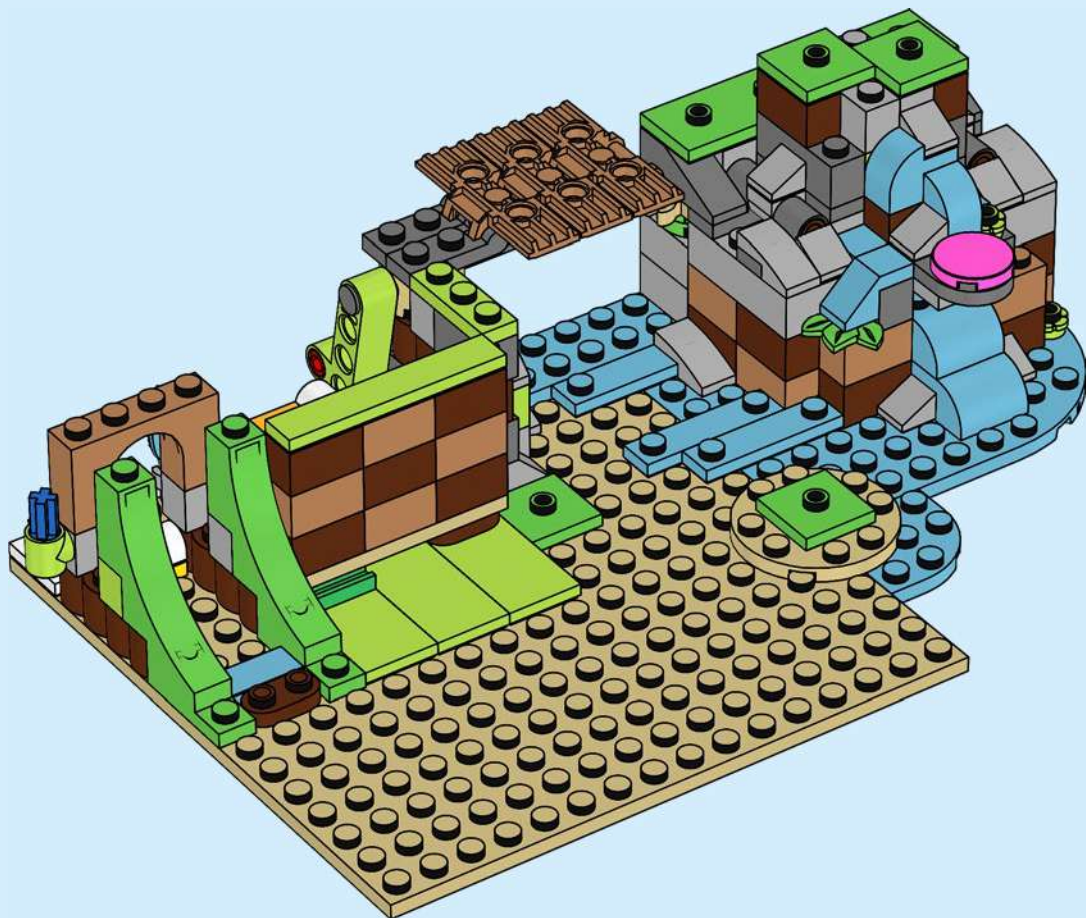



1x



1x

69

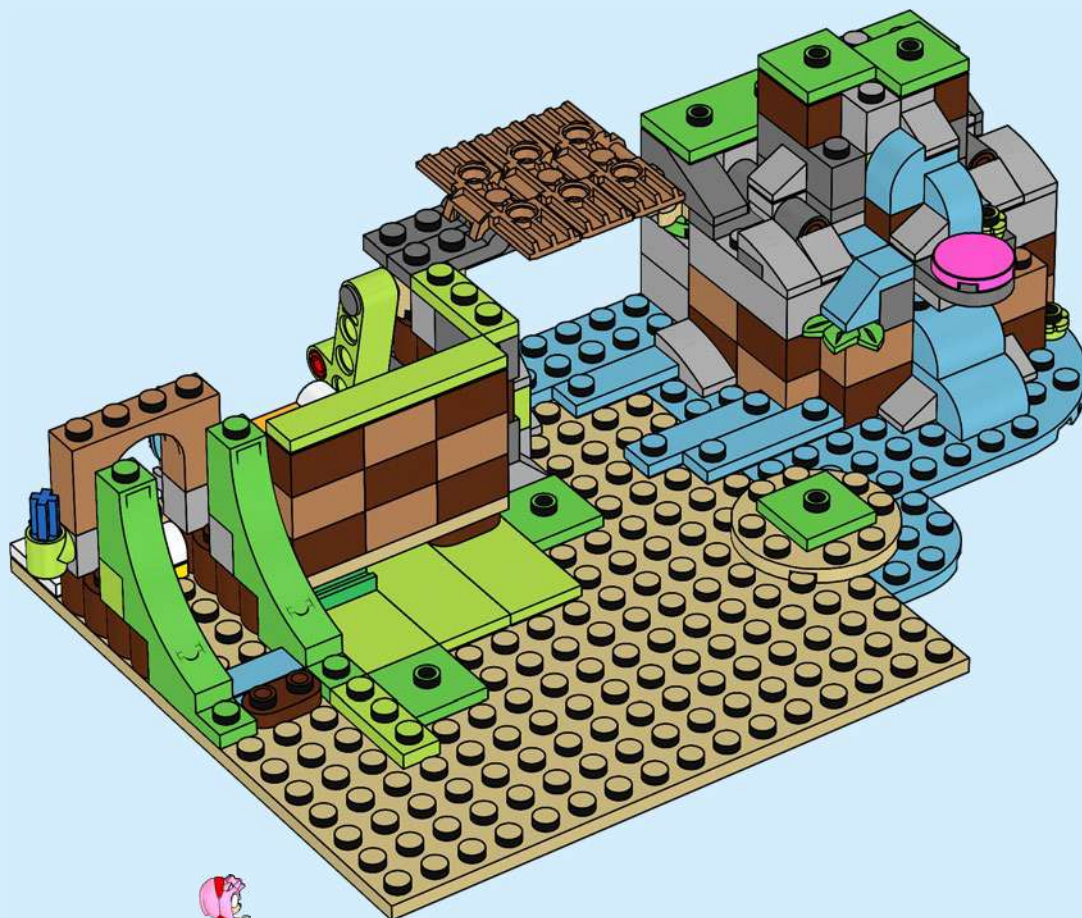



2x



1x

70

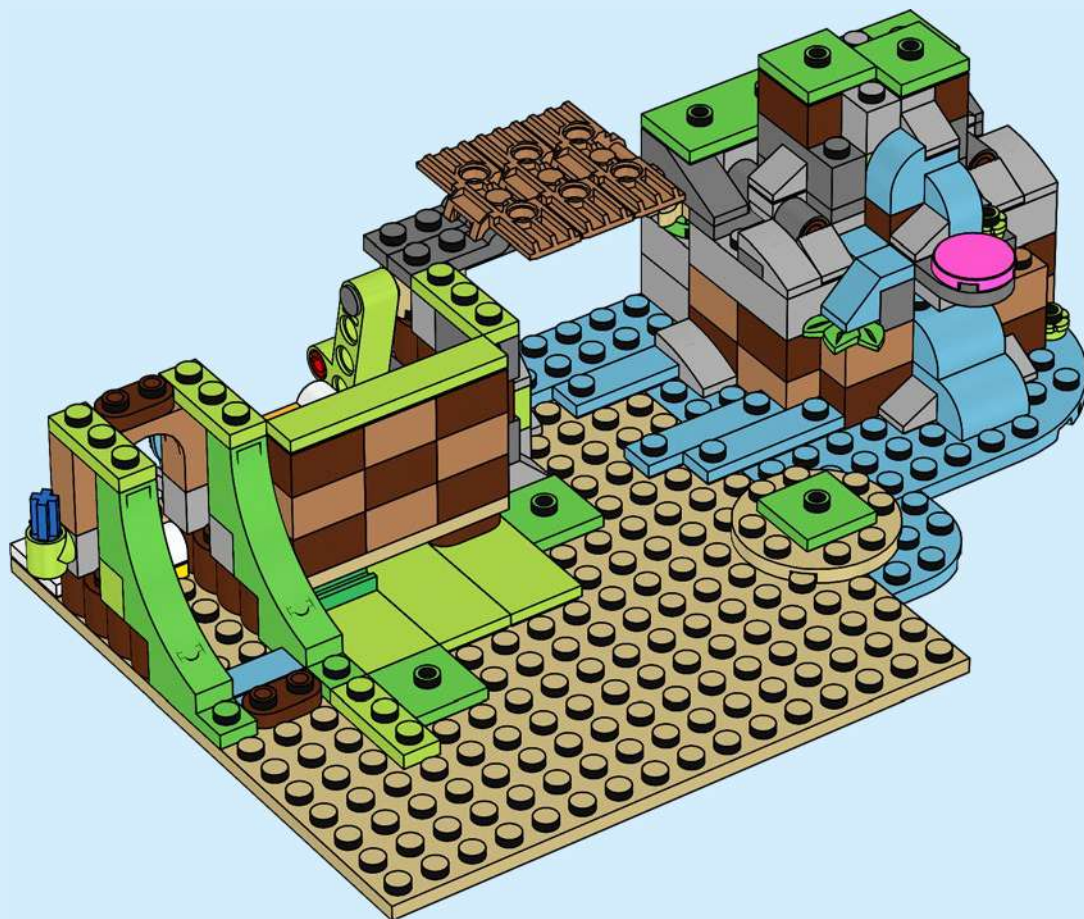

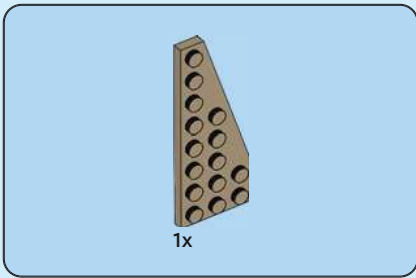

71

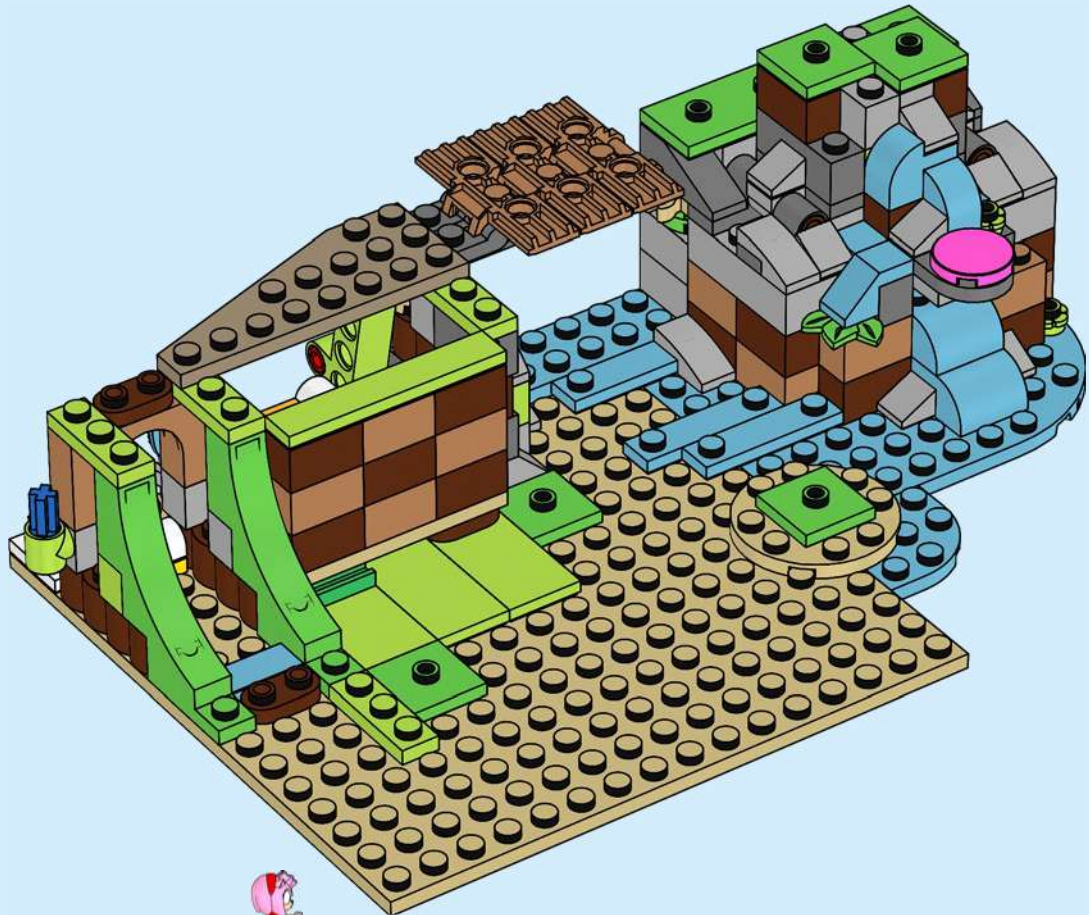



2x

72

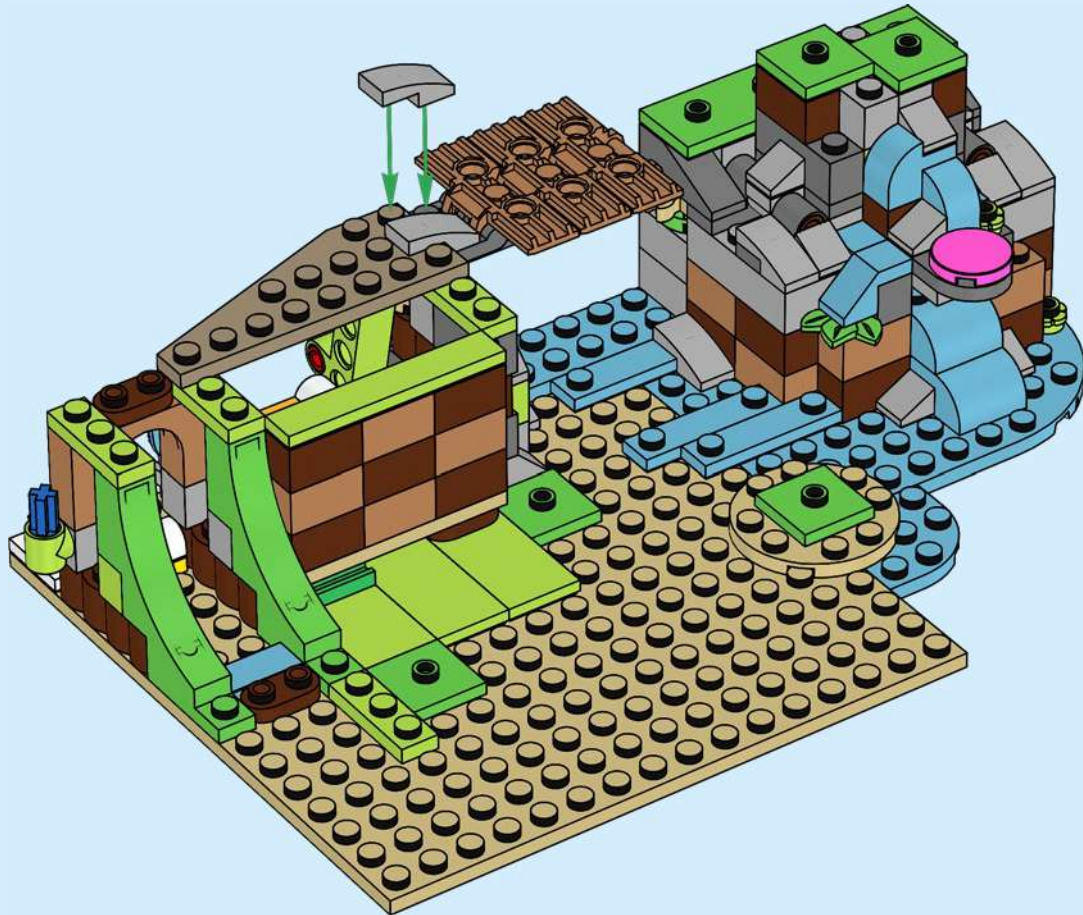



1x



2x

73

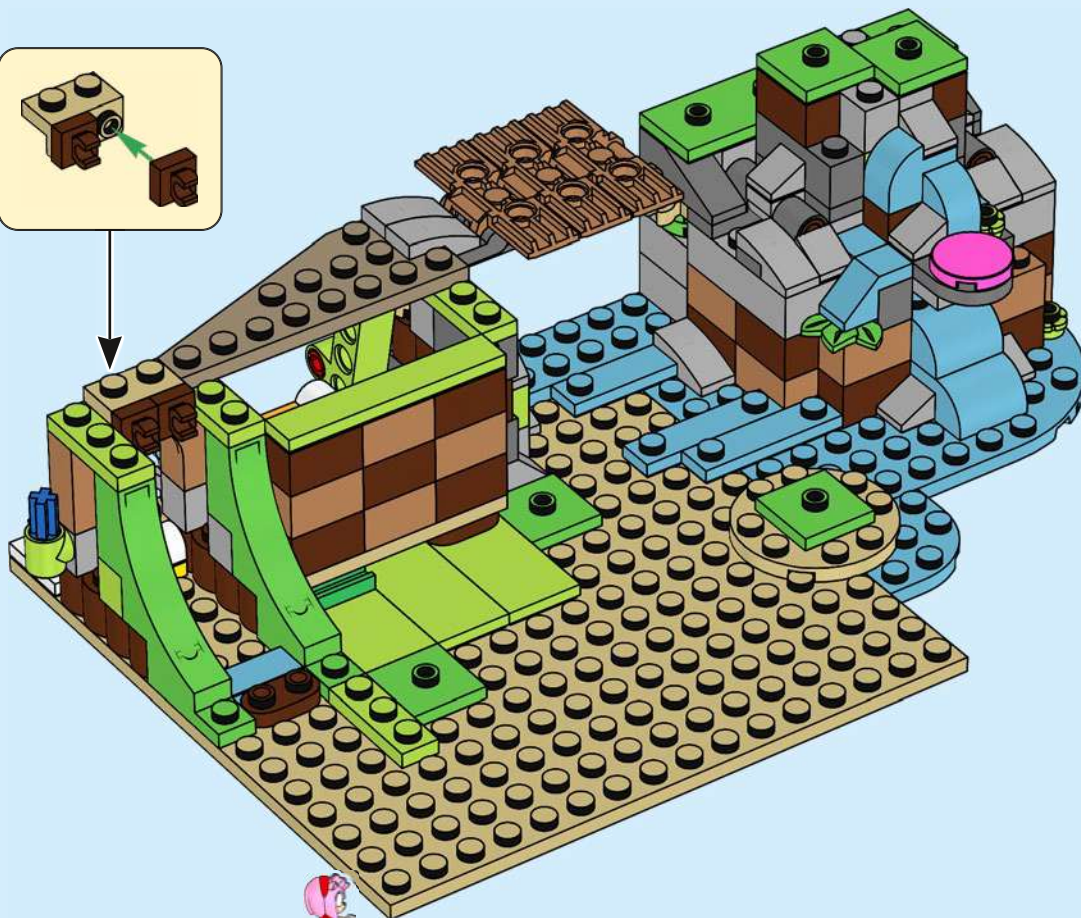
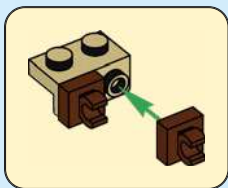

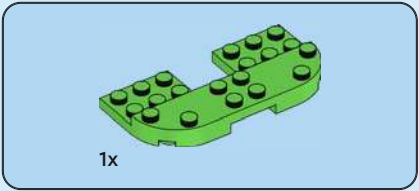

74

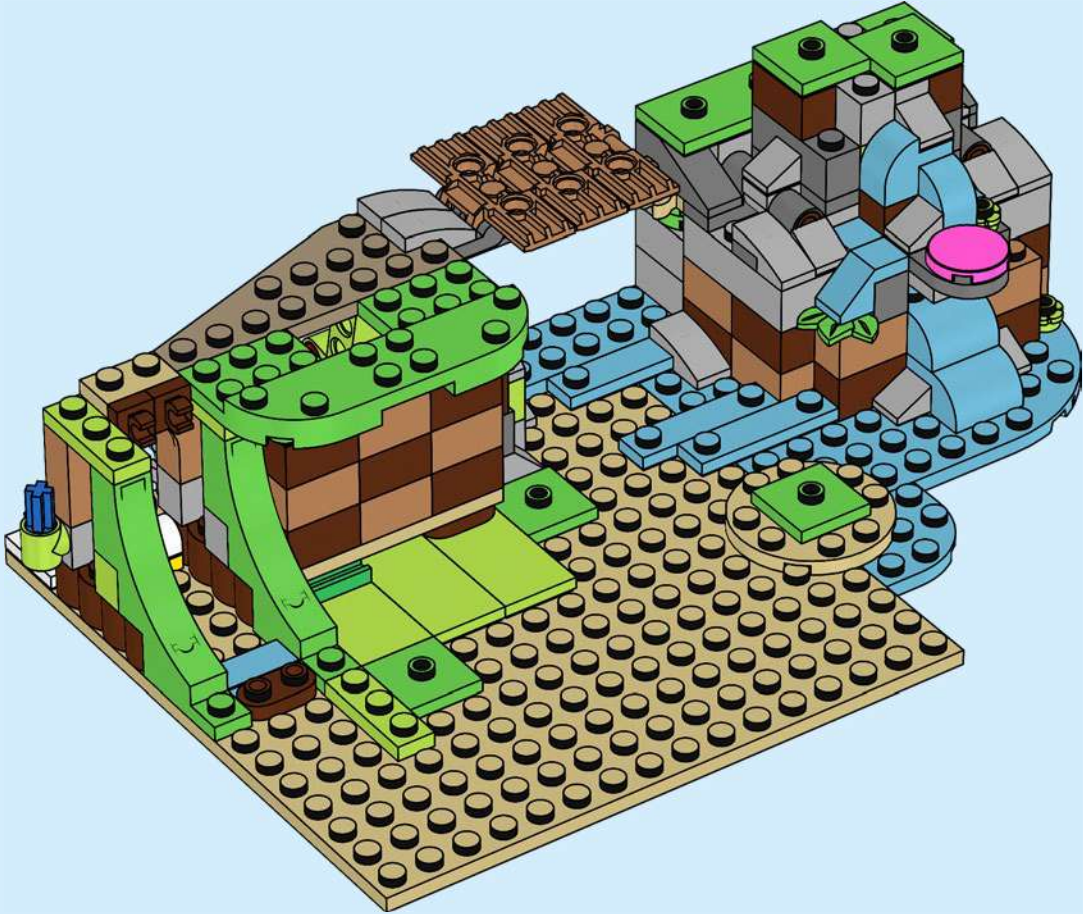



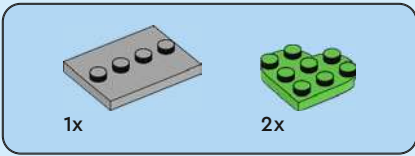

75

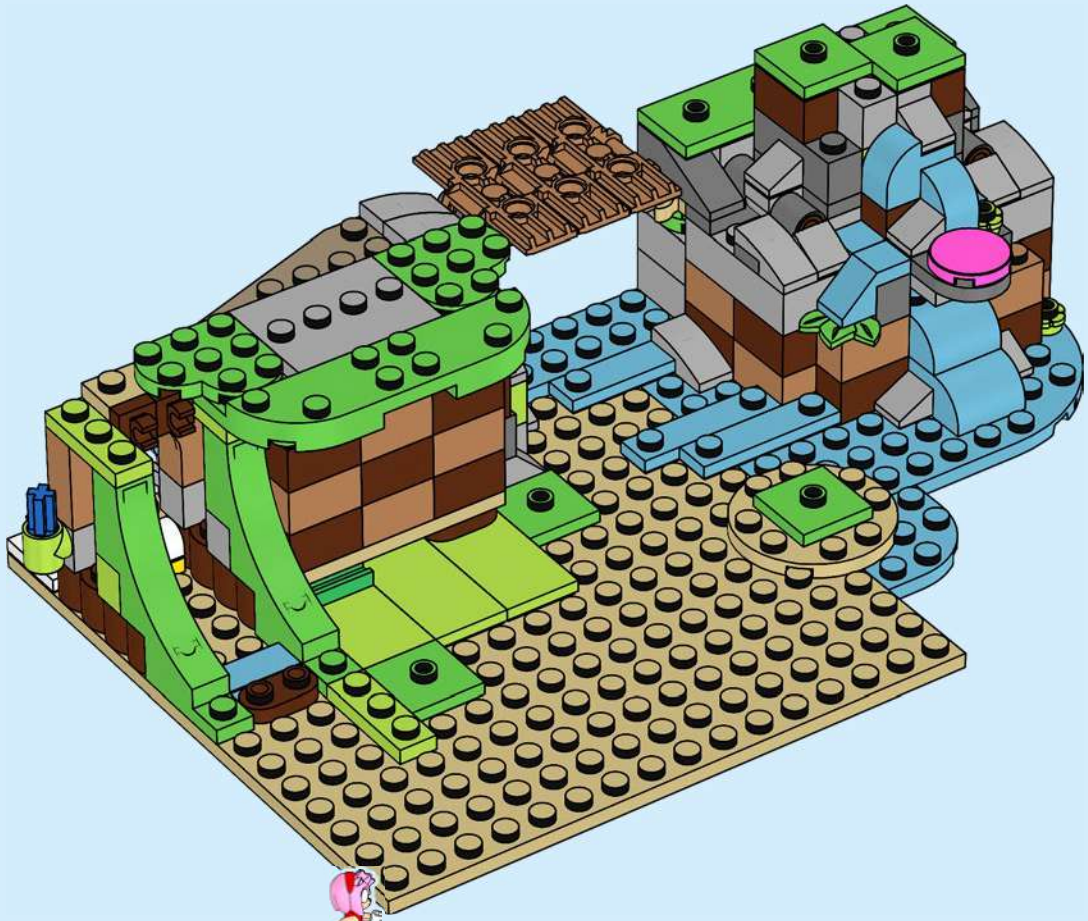

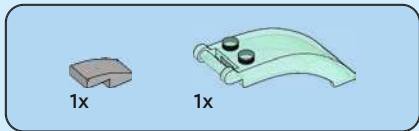

76



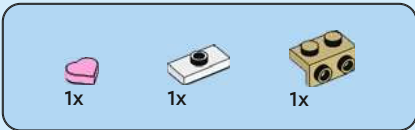

77

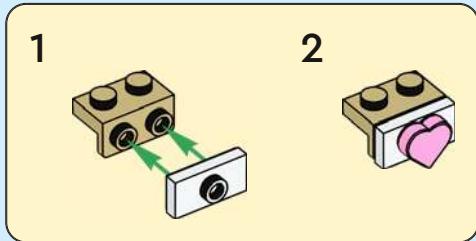

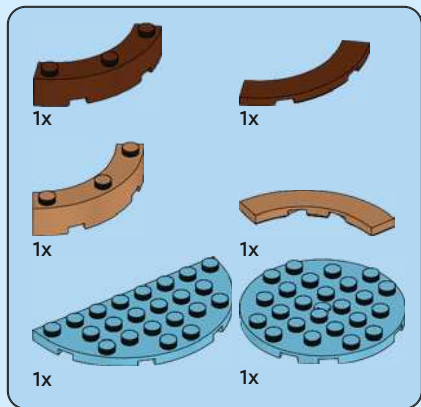

78

1

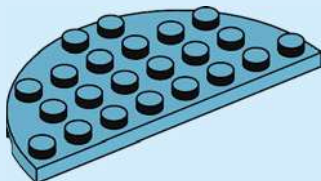

2

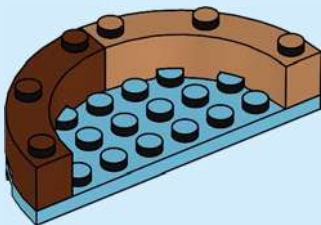

3



4





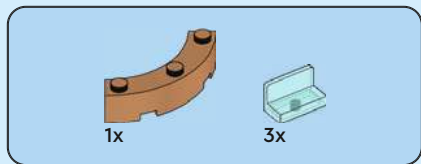

79

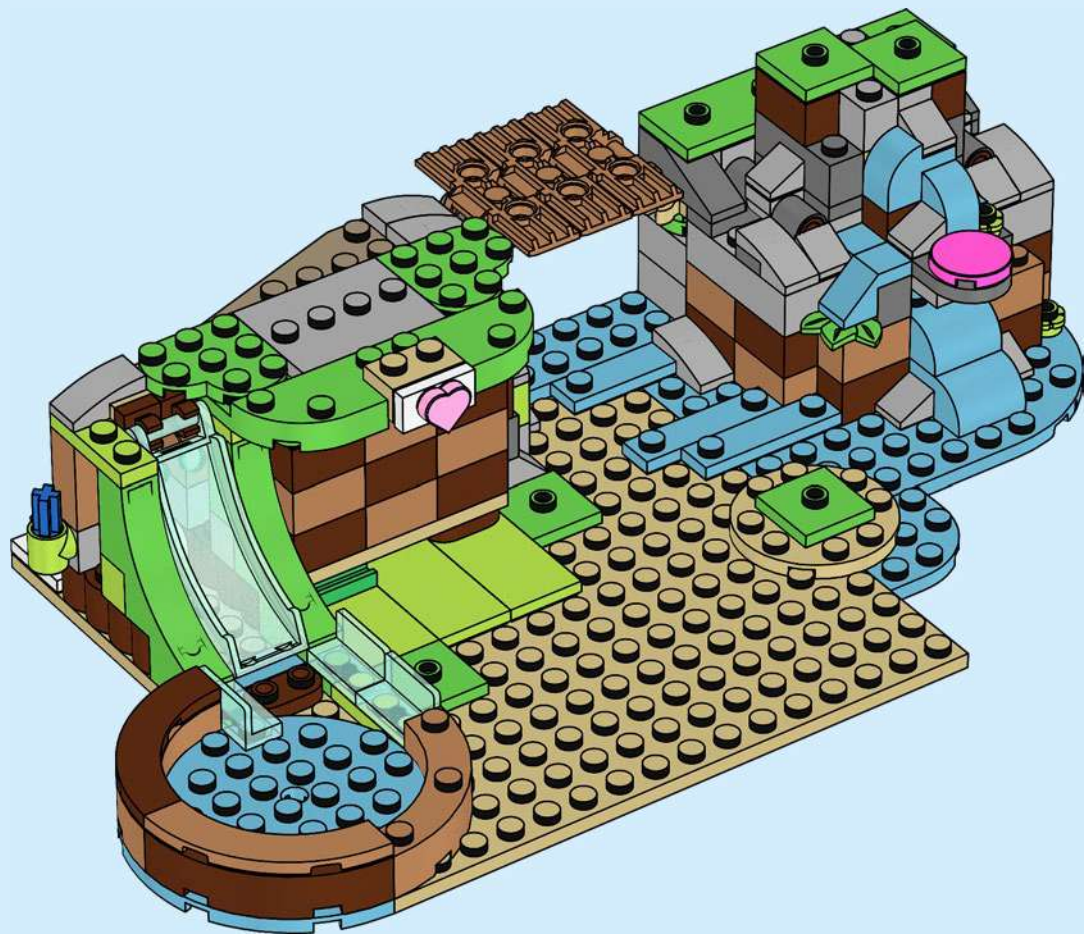

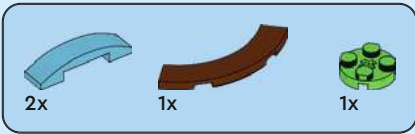

80

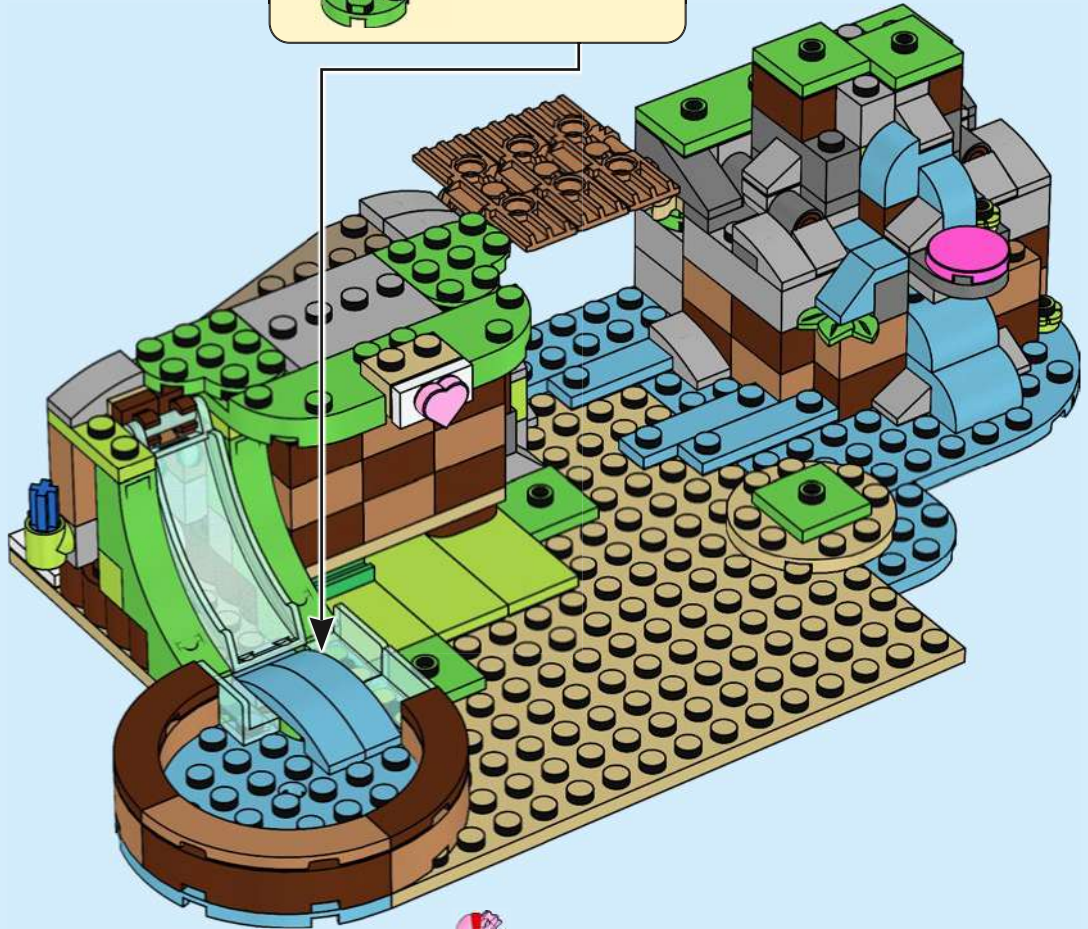
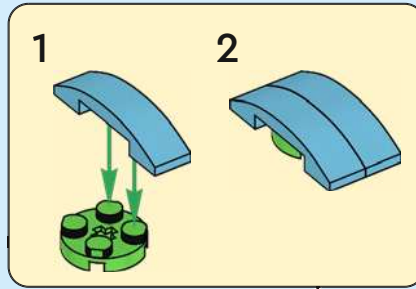





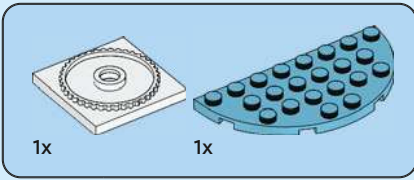

81

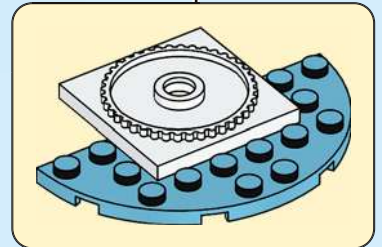
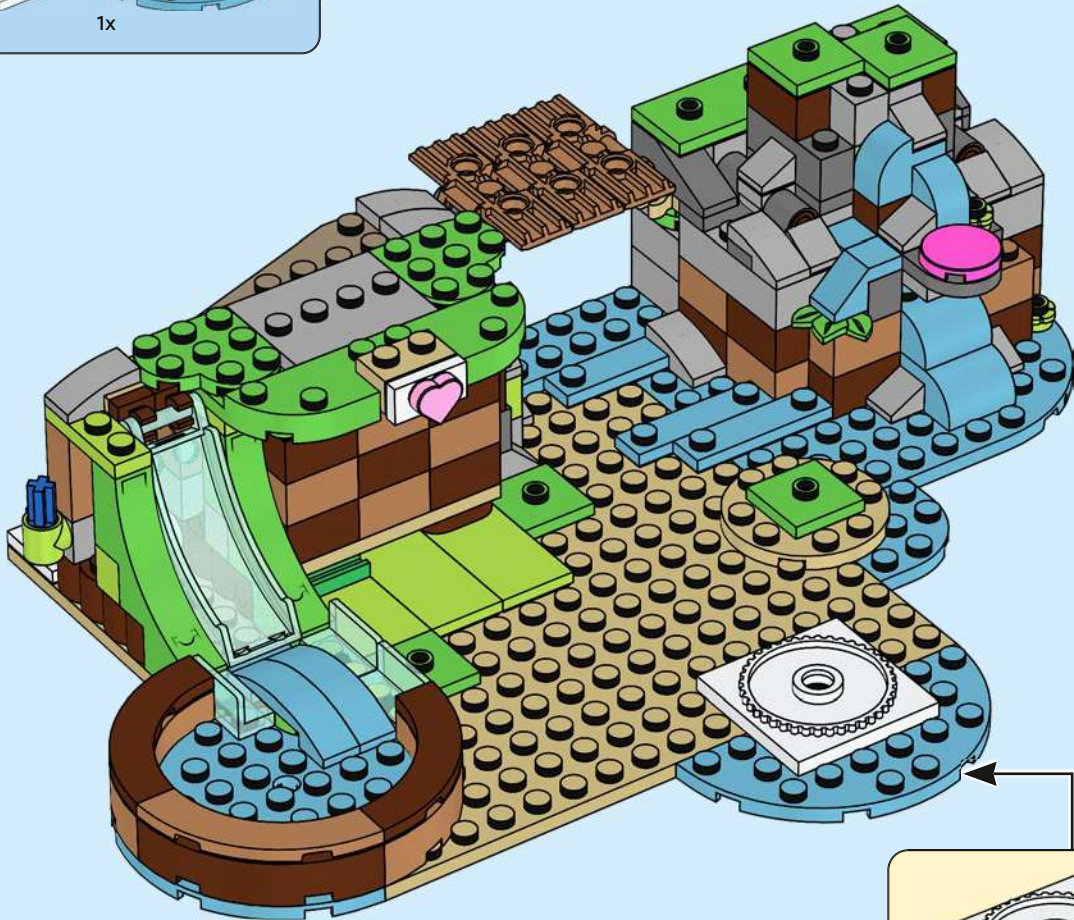



2x

82

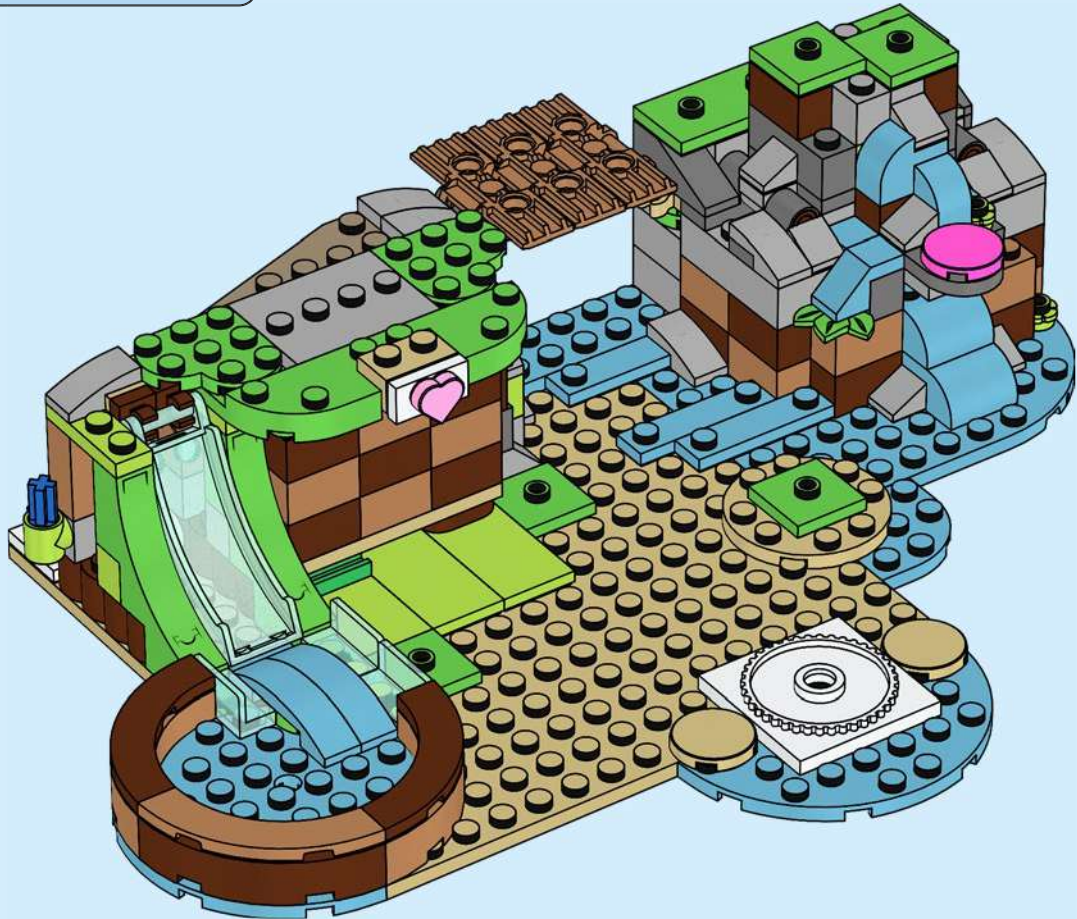

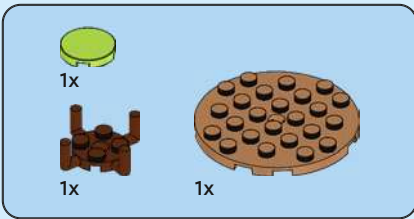

83

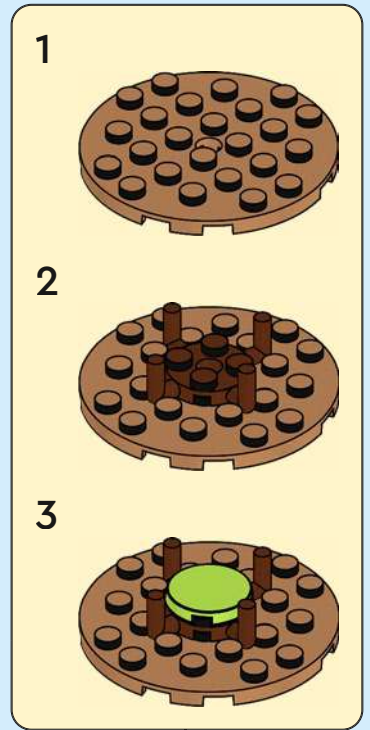
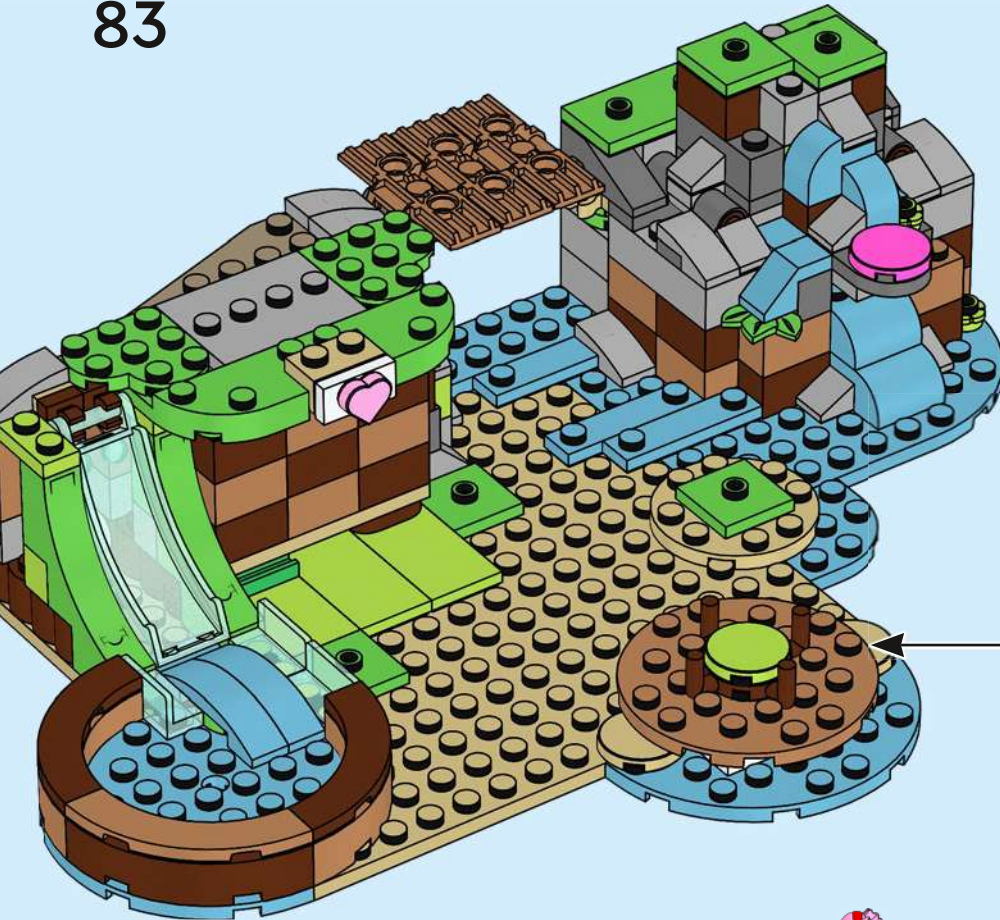



1x



1x

84

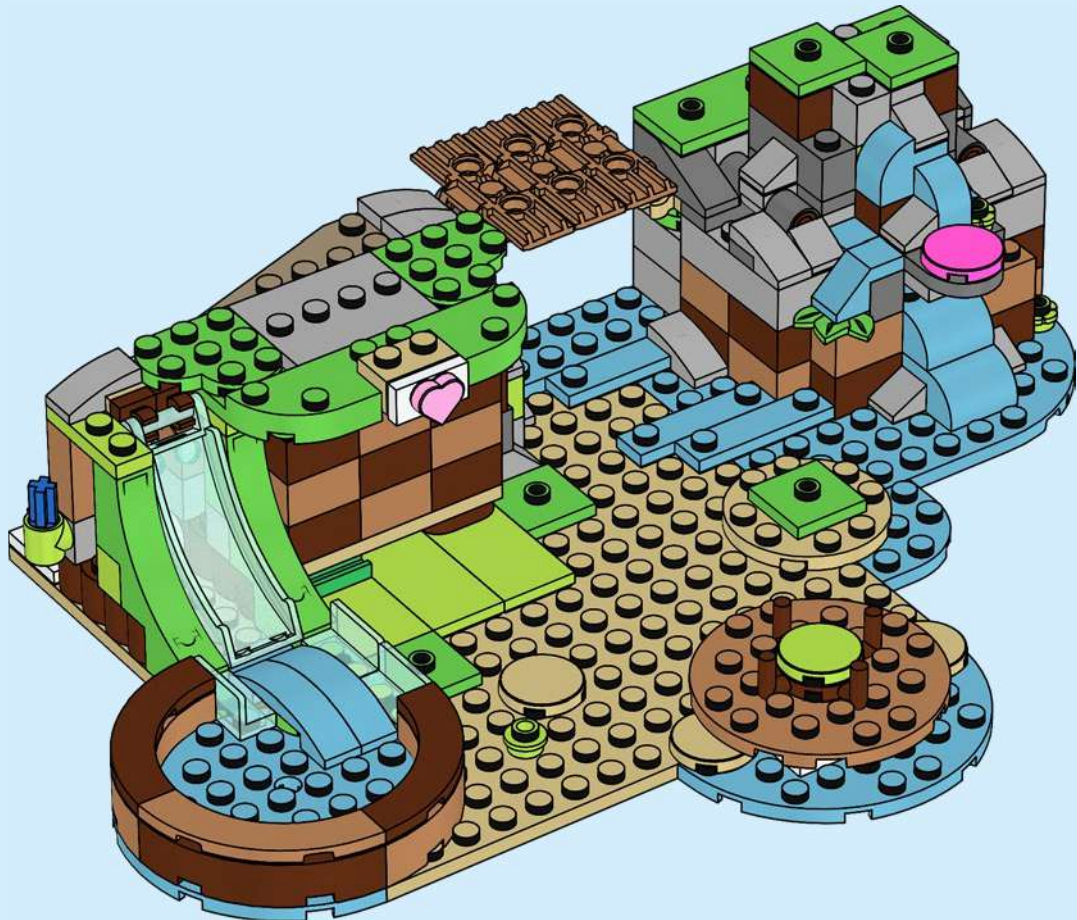



2x



1x

# 85

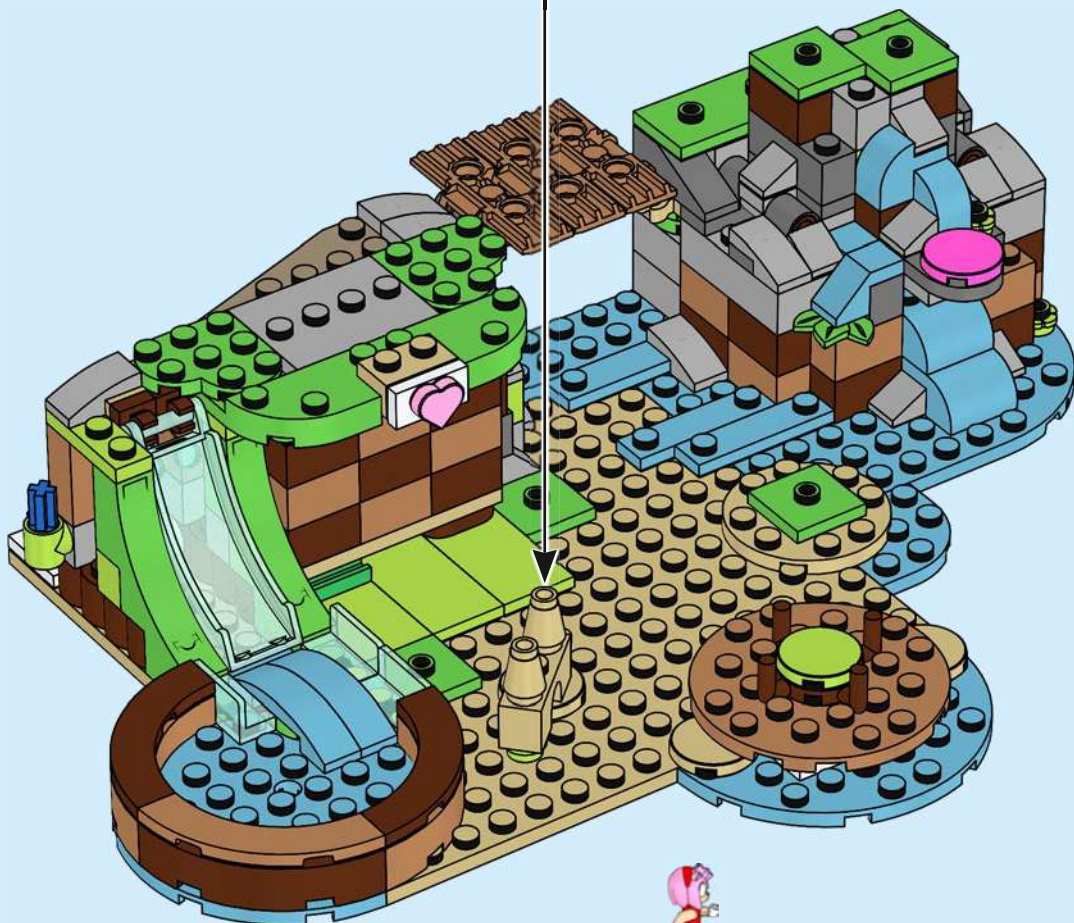
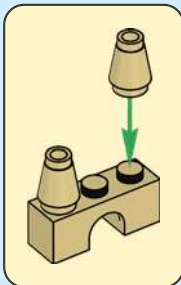



1x



1x

86

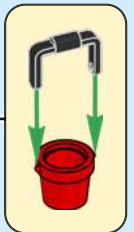
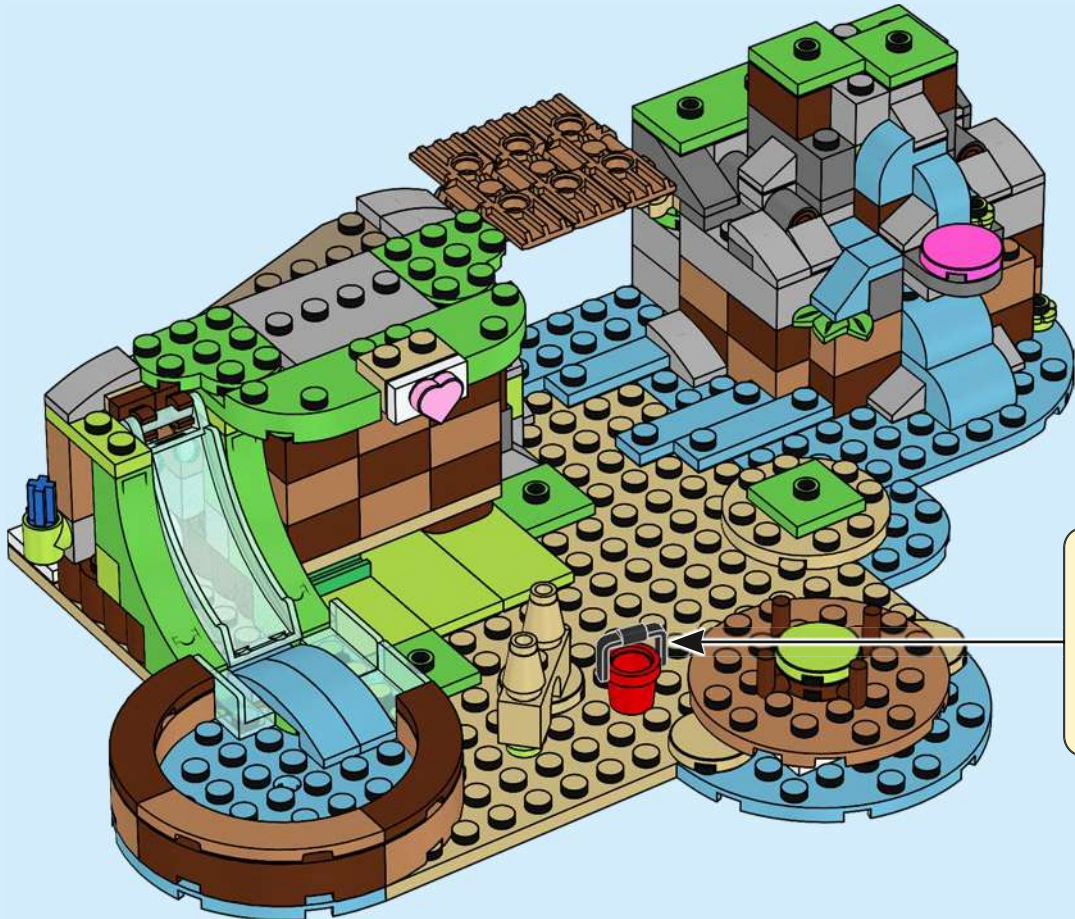

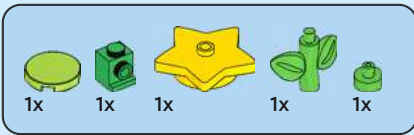

87

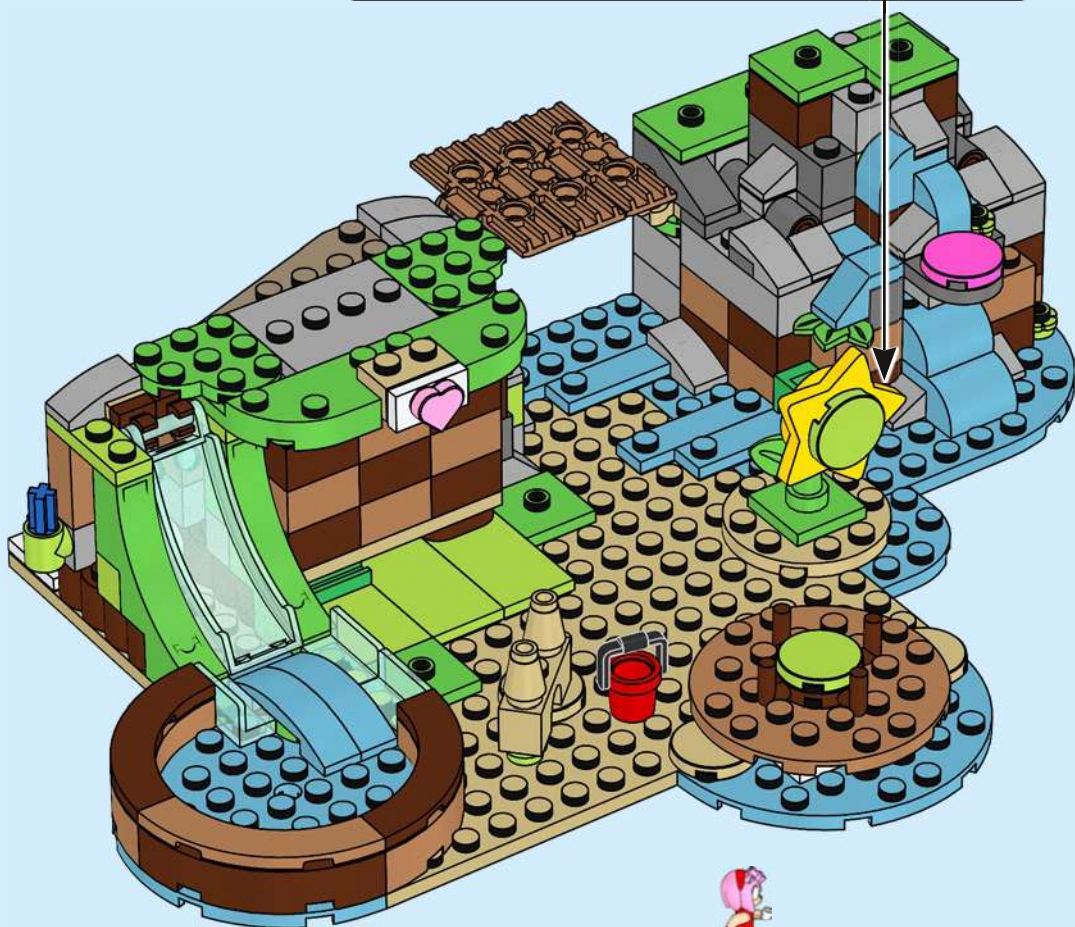
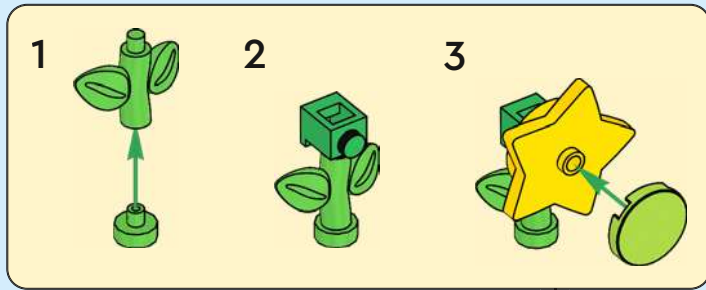

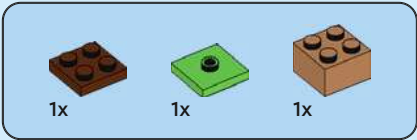

88

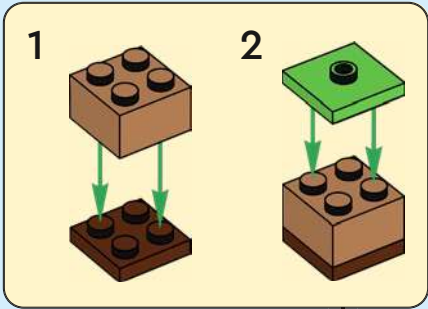



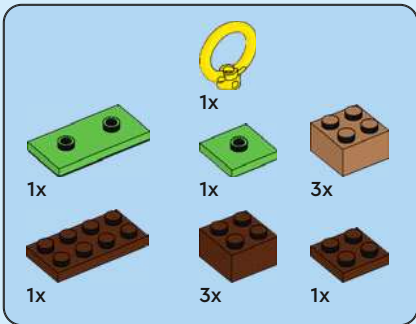

89

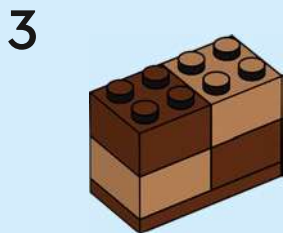

4

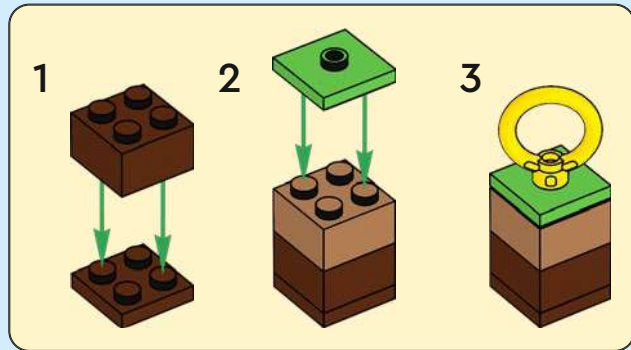
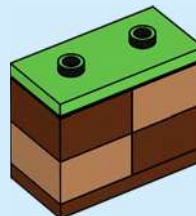

5







2x

90

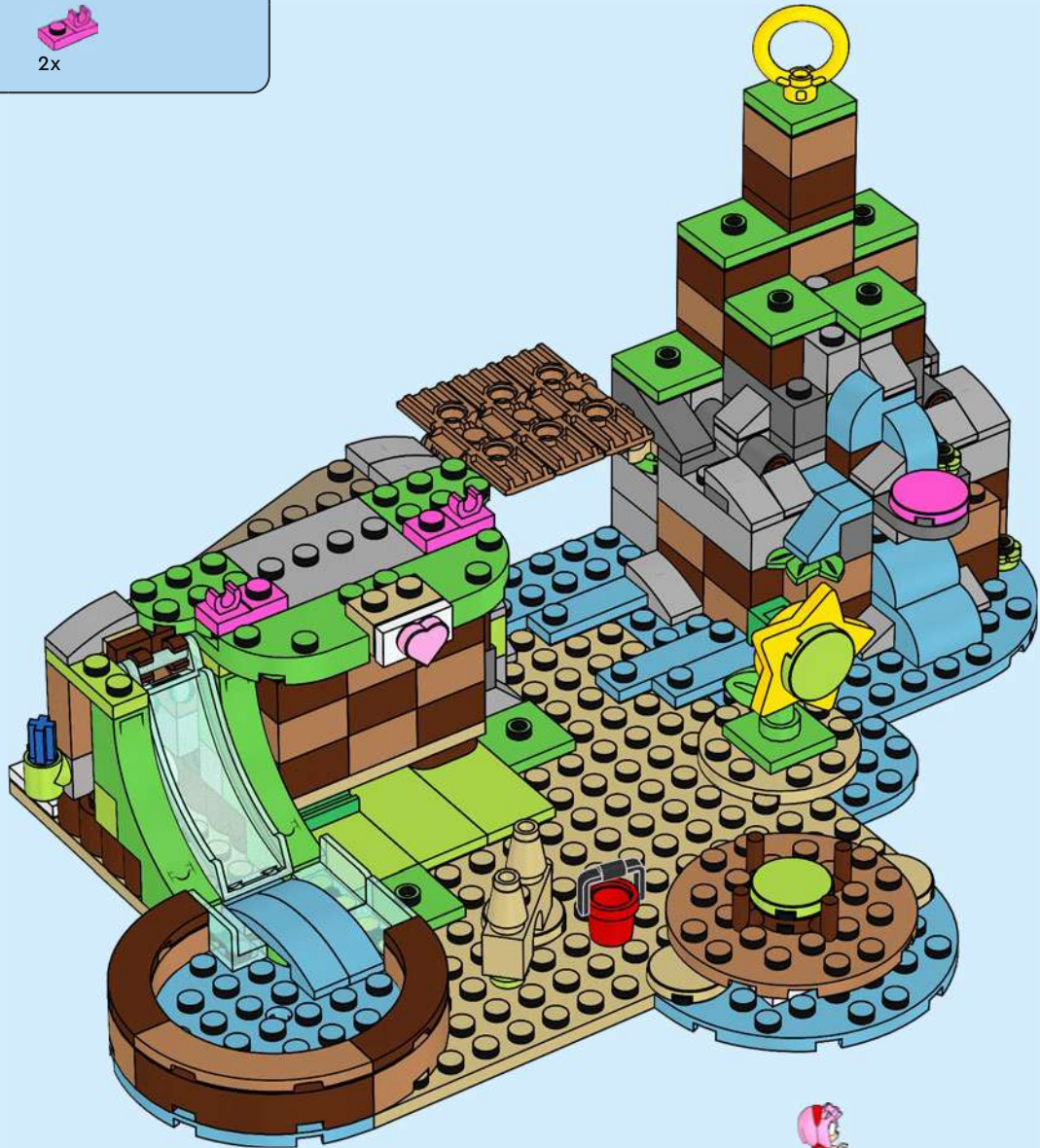



1x

91



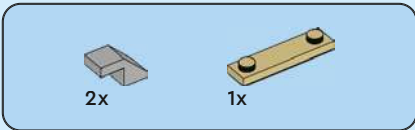

92

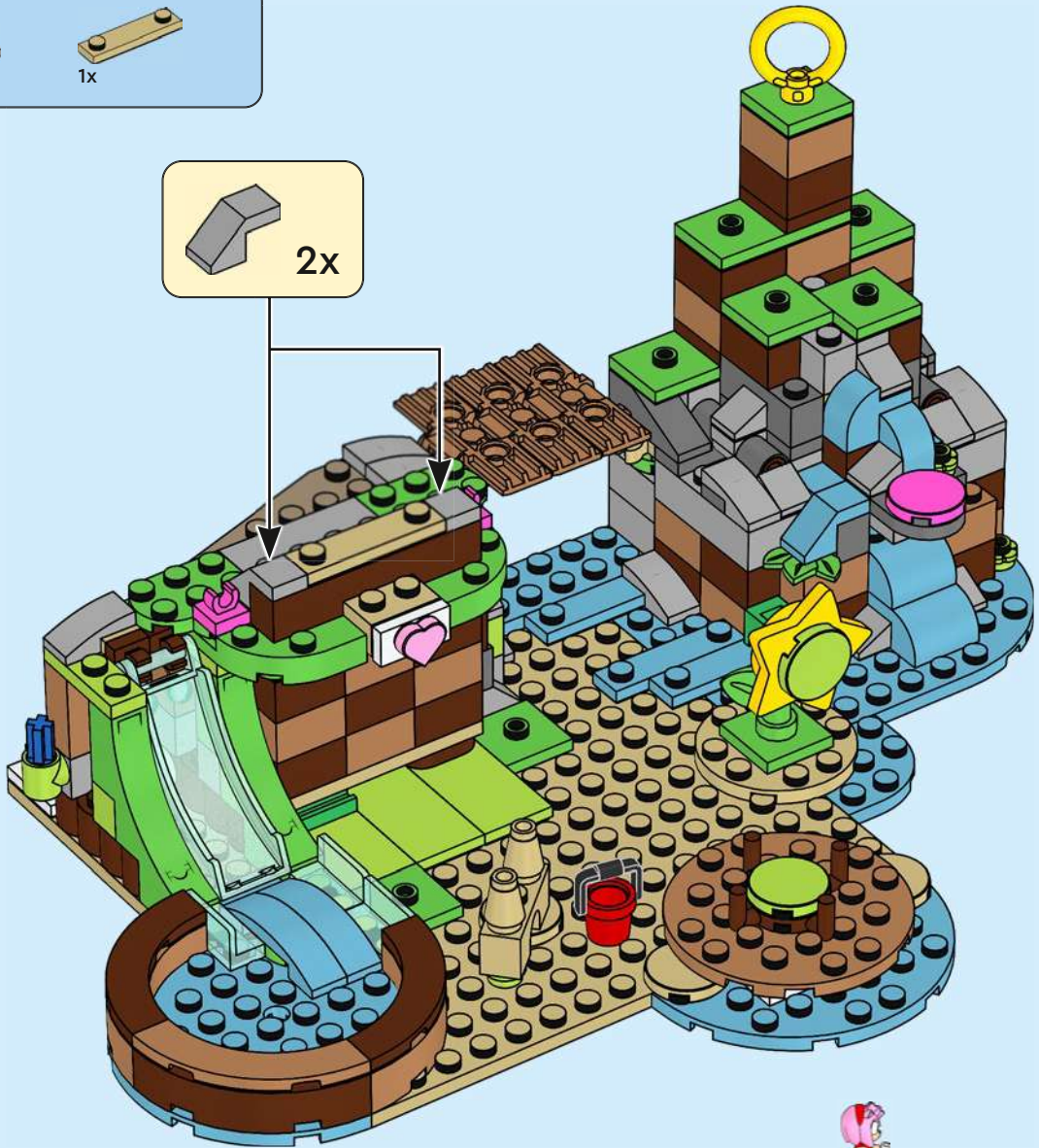
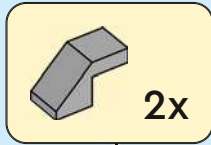

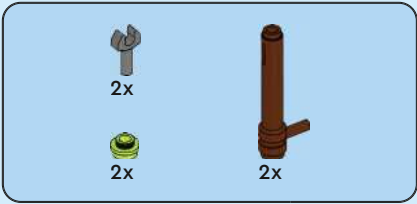

93

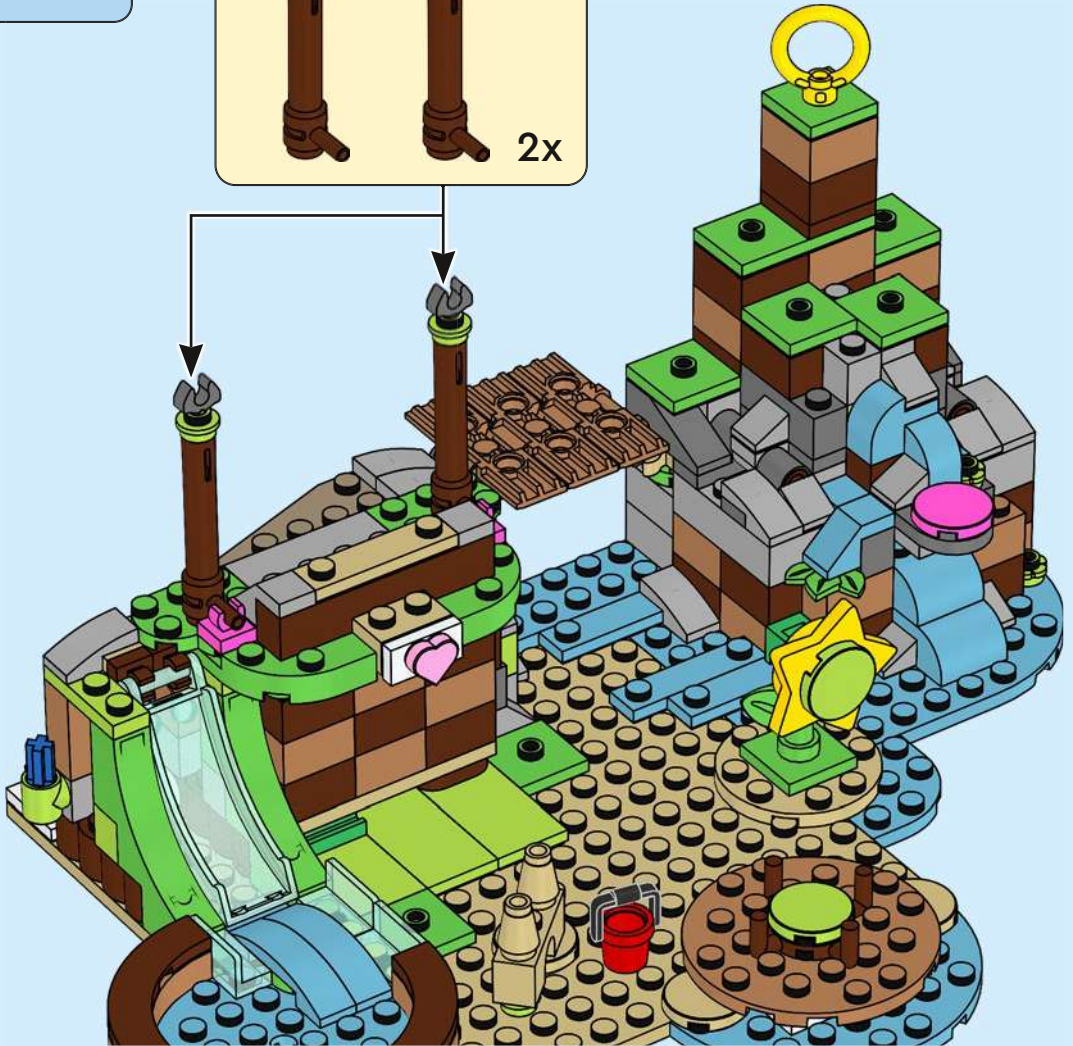
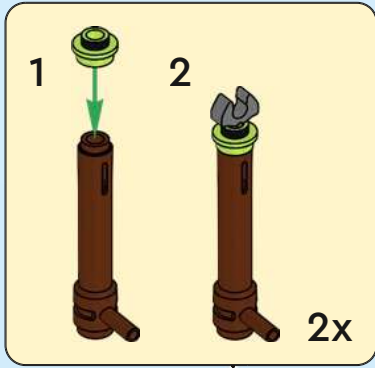



94

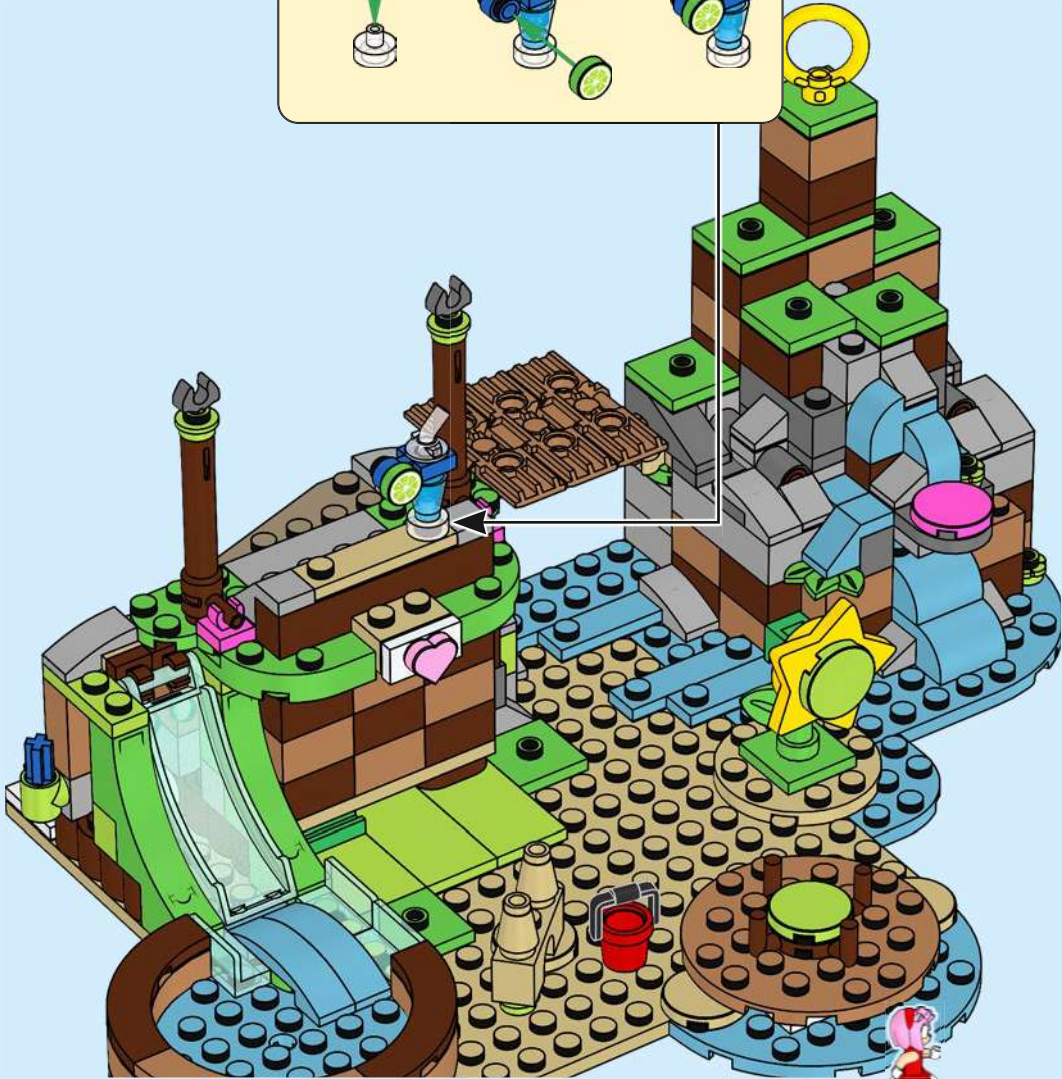
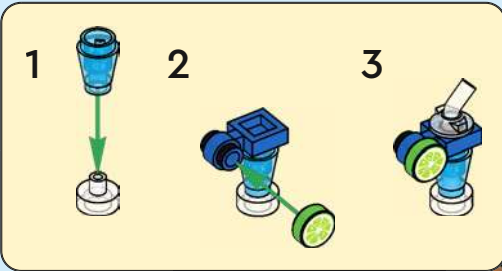

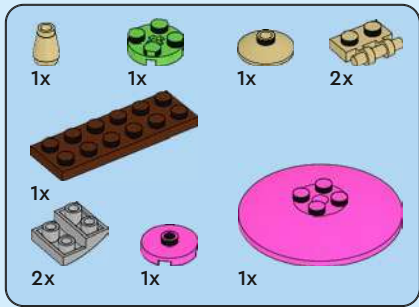

95

1

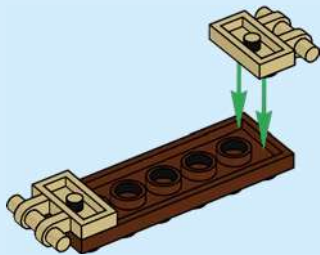

2



3

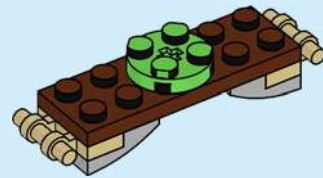

4

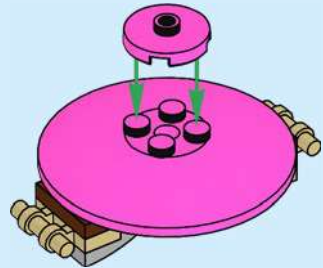

5

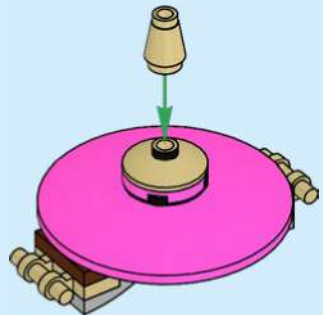



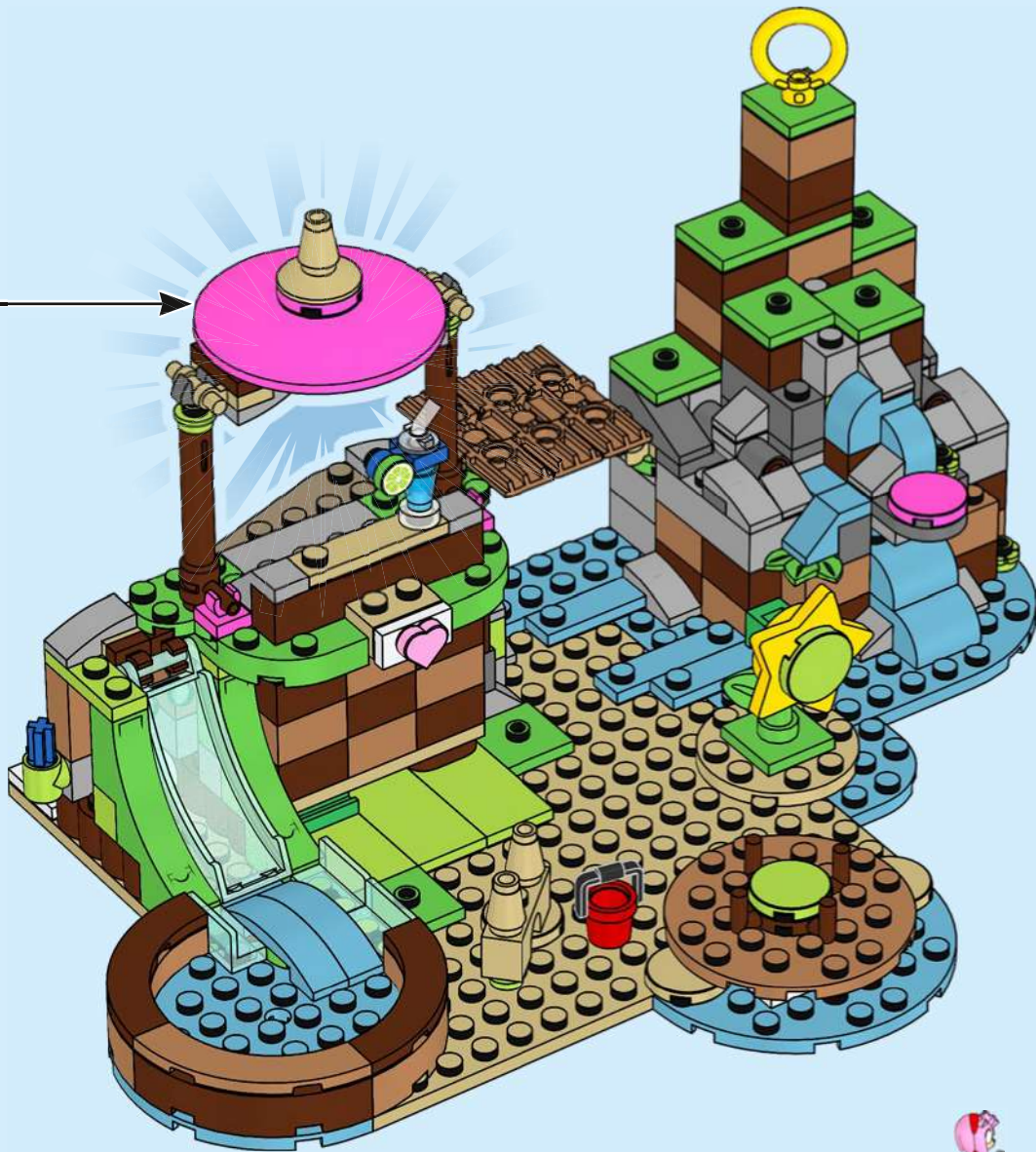

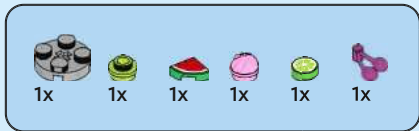

96



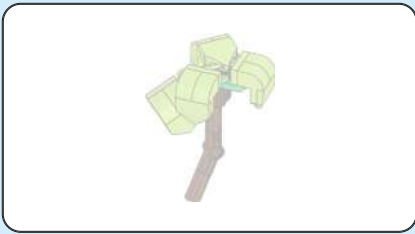

97



98

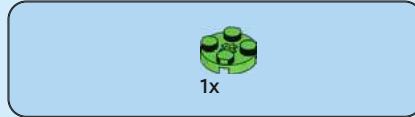

99



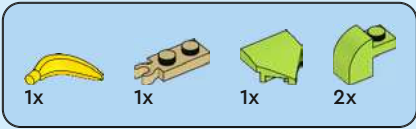

100

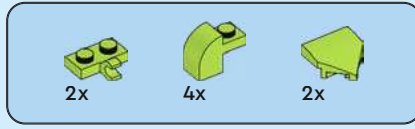
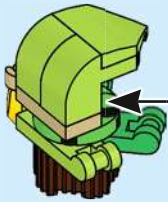
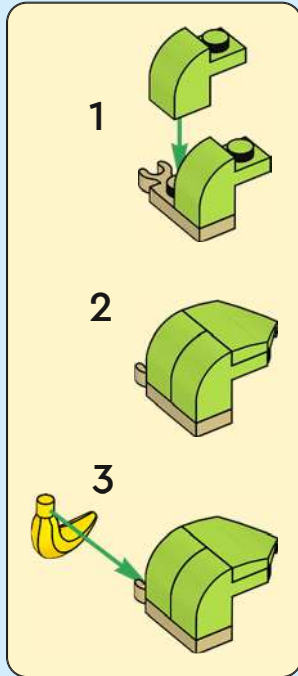

101

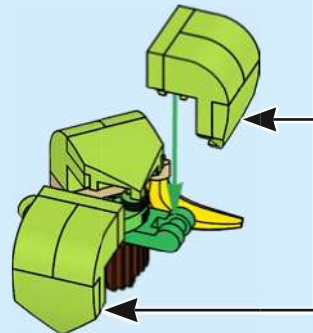
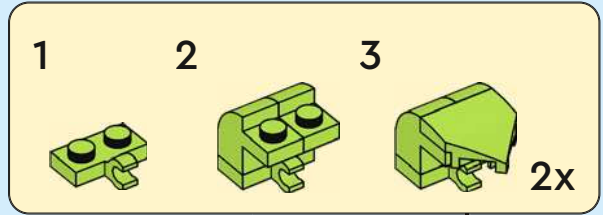

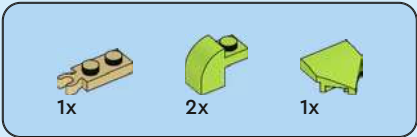

102

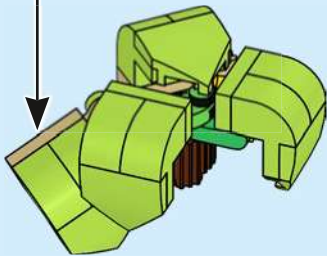
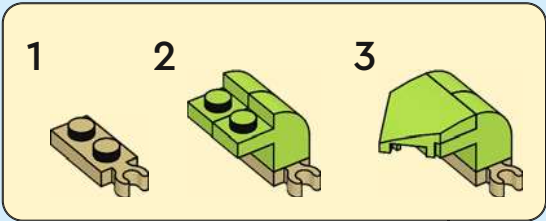

103

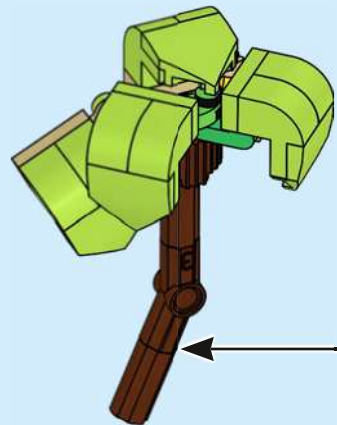
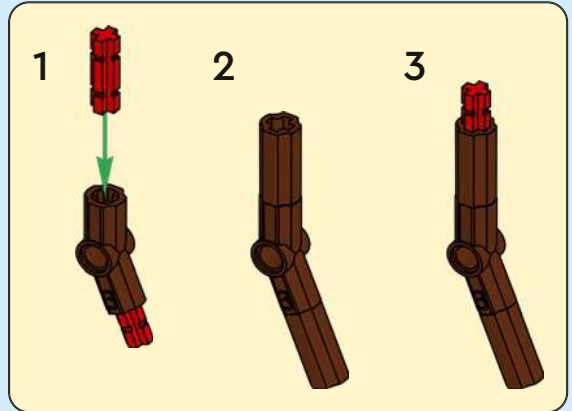

104







# SONIC™

## THE HEDGEHOG











































































































76990

Combine sets to  
expand your play!

Combine sets to expand your play!  
Kombiniere Sets für noch mehr Spielspaß!  
Combine les niveaux pour étendre ton expérience de jeu !  
Combina i set per espandere il tuo gioco!  
¡Combina sets para jugar mucho más!  
Combina sets para expandir os teus momentos de diversão!  
组合系列套装, 增强玩乐体验!  
Łącz zestawy i baw się jeszcze lepiej!  
Kombinujte stavebnice a rozšiřujte svou hru!  
Kombinujte stavebnice a rozšiřujte herné možnosti!  
A készletek egyesítésével bővítsd a játékot!  
Combina seturi pentru a-ți extinde joaca!  
Комбинируйте комплекты за по-интригующая игра!  
Arvieno komplektus, lai pilnveidotu savas rotaļas!  
Kombineeri komplekte, et mängu laiendada!  
Derinkite rinkinius ir išplėskite žaidimą!





 1x 6398468	 2x 6446092	 3x 4211181	 2x 6168633	 1x 6176242	 3x 6178919	 1x 6424008	 1x 6058368
 2x 6214457	 1x 6036503	 1x 4211186	 2x 6043656	 1x 6079461	 4x 4211063	 2x 6275466	 1x 4649741
 2x 6359040	 2x 4531751	 1x 4211193	 2x 6248492	 1x 6079461	 2x 4210795	 1x 6423955	 3x 6296622
 1x 6443193	 2x 4531751	 1x 4211193	 1x 4654582	 1x 4211795	 2x 6123814	 1x 6452559	 2x 6335566
 1x 6443193	 9x 4211149	 2x 6176608	 1x 6310976	 1x 6443198	 2x 4234534	 1x 6443212	 1x 6264993
 1x 6443192	 2x 6345000	 1x 4211247	 1x 6212077	 1x 6174946	 2x 4521187	 1x 6443196	 2x 6146866
 4x 6193972	 1x 6330241	 2x 6326748	 1x 6212077	 2x 6223767	 2x 4521187	 1x 6147169	 3x 6252704
 1x 6452547	 3x 4211210	 8x 4521921	 3x 4211349	 2x 6375007	 2x 4211045	 10x 4569382	 2x 6097093
 1x 6443191	 2x 4216695	 1x 6336539	 2x 6185676	 1x 6452622	 2x 4211104	 2x 6022004	 1x 6029690
 1x 6443191	 1x 6313506	 1x 6345426	 2x 4645397	 1x 6452622	 1x 4225733	 4x 6058085	 1x 6253666
 1x 6170813	 2x 6135494	 2x 6407767	 2x 6093058	 4x 6336970	 2x 4211045	 1x 6174192	 2x 6138571
 2x 6348057	 1x 6261388	 2x 4211475	 2x 6421522	 1x 6395635	 2x 4211105	 3x 6442980	 2x 6138571
 4x 6248944	 4x 4216668	 4x 4211614	 1x 4211396	 2x 6390673	 1x 6106191	 1x 6387478	 1x 6380619
 4x 6248944	 4x 4216668	 7x 6028813	 3x 4211385	 4x 6019987	 1x 4499858	 1x 6387478	 1x 6380619



6x 6258135  
2x 6051511  
1x 371001  
1x 4611927  
4x 4529237  
2x 4118793  
3x 6066344  
1x 6232037  
1x 4617765  
1x 6092587  
2x 6249809  
2x 4140593  
4x 6372047  
2x 6212038

1x 4618651  
1x 6257600  
1x 6302268  
1x 4124067  
1x 4611414  
2x 6443195  
1x 6003001  
4x 4504379  
1x 6360104  
1x 6210269  
4x 6335377  
2x 403221

1x 302224  
1x 4114584  
3x 302124  
1x 6248804  
3x 4206482  
1x 6281991  
1x 6289740  
1x 6289743  
1x 403224  
1x 6441692  
2x 6437958

1x 6186867  
1x 6285587  
1x 6028018  
1x 6247792  
3x 6246890  
1x 6173922  
4x 4142865  
8x 6029946  
2x 6442314  
1x 6453242  
1x 6466206  
1x 487121

1x 6245281  
1x 6020193  
1x 6247796  
2x 6273627  
1x 6301313  
1x 6443197  
1x 4187334  
1x 6151225  
2x 6253140  
1x 4272665  
2x 6435099  
1x 6400649  
1x 6182261  
1x 243128

5x 6138624  
1x 6400112  
7x 6389695  
2x 6294357  
3x 6293826  
2x 6442978  
1x 6340682  
1x 6412881  
1x 6100562  
1x 6290571  
1x 6442979

5x 6209692  
4x 6190251  
1x 6332867  
1x 6133859  
1x 6325515  
4x 6210210  
1x 6271826  
3x 6212989

7x 4220634  
2x 6092766  
2x 6334046  
1x 6308234  
8x 411328  
4x 6442920  
1x 6167465  
1x 6345302

LEGO.com/service

YOU COULD **WIN**



Scan this QR code or go to **LEGO.COM/PRODUCTFEEDBACK** and give us your short feedback about this LEGO® set for a chance to win a cool LEGO prize.

Terms and Conditions apply\*

**EN: YOU COULD WIN.** Terms and Conditions apply\* **DE: Du könntest GEWINNEN.** Es gelten die Teilnahmebedingungen\* **FR: Tu pourrais GAGNER.** Des conditions s'appliquent\* **IT: Potresti VINCERE tu.** Termini e condizioni sono applicabili\* **ES: Puedes GANAR.** Aplican términos y condiciones\* **PT: Poderá GANHAR.** Aplicam-se termos e condições\* **ZH: 轻松获奖. 条款和条件适用\*** **PL: Szansa na WYGRANĄ.** Obowiązują warunki korzystania\* **CS: Máte šanci VYHRÁT.** Platí všeobecné smluvní podmínky\* **SK: Máte šancu VYHRAŤ.** Platia všeobecné zmluvné podmienky\* **HU: TE IS NYERHETSZ.** Felhasználási feltételek érvényesek\* **RO: Ai putea CÂȘTIGA.** Se aplică termeni și condiții\* **BG: Можете да СПЕЧЕЛИТЕ.** Има определени правила и условия\* **LV: Tu vari LAIMĒT.** Ir spēkā noteikumi un nosacījumi.\* **ET: Sul on võimalus VÕITA.** Kehtivad tingimused\* **LT: Jūs galite LAIMĖTI.** Taikomos sąlygos\*

\*[LEGO.com/productfeedback-terms](https://www.lego.com/productfeedback-terms)

LEGO and the LEGO logo are trademarks of the LEGO Group. ©2023 The LEGO Group.  
©SEGA. All rights reserved. SEGA is registered in the U.S. Patent and Trademark Office.  
SEGA and SONIC THE HEDGEHOG are either registered trademarks or trademarks of SEGA CORPORATION.