



DREAMZZZ

71453





FR
DONNEZ
OU
RECYCLEZ

ASSOCIATION OU MAGASIN OU DÉCHÈTERIE

Adresses sur quefairedemesdechets.fr



LEGO.com/sustainable-packaging

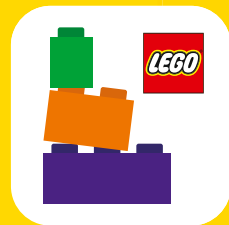

BUILDER



Apple and the Apple logo are trademarks of Apple Inc., registered in the U.S. and other countries and regions. App Store is a service mark of Apple Inc. Google Play and the Google Play logo are trademarks of Google LLC. Tencent and the Tencent logo are trademarks of Tencent Inc.

Q [LEGO.com/devicecheck](https://www.lego.com/devicecheck)

EN Ask parents' permission before going online | **DE** Eltern um Erlaubnis bitten, bevor du online gehst | **FR** Demande l'autorisation d'un parent avant d'aller en ligne | **IT** Chiedi il permesso ai tuoi genitori prima di andare online | **ES** Pídeles permiso a tus papás antes de conectarte a Internet | **PT** Peça autorização aos pais antes de acederes online | **ZH** 上网前应先征得父母的同意 | **PL** Poproś rodziców o zgodę, zanim wejdiesz do Internetu | **CS** Než půjdeš na internet, požádej rodiče o svolení | **SK** Skôr než pôjdeš na internet, vypýtaj si povolenie od rodičov | **HU** Kérj szülői engedélyt, mielőtt online csatlakoznál! | **RO** Cere permisiunea părinților înainte de a te conecta online | **BG** Поискайте разрешение от родител, преди да влезете онлайн | **LV** Pirms došanās tiešsaistē palūdz atļauju vecākiem | **ET** Enne Interneti kasutamist küsi vanematelt luba | **LT** Prieš prisijungdami prie interneto, atsiklauskite tėvų





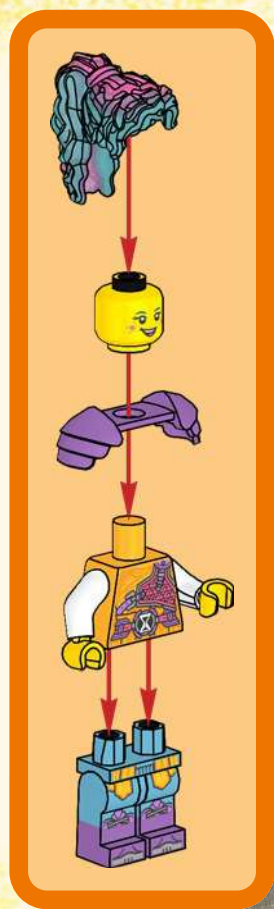

WUHAAA









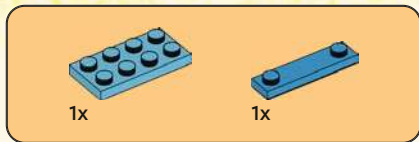

1

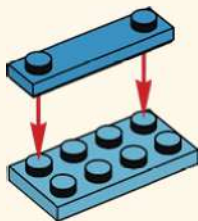

2

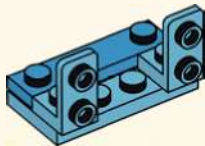

3

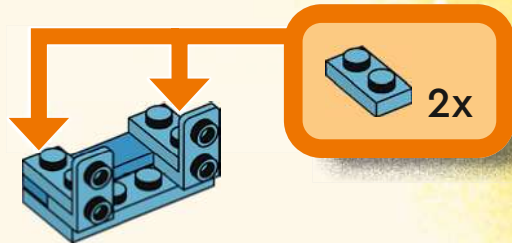

4

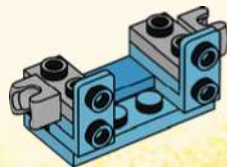



2x

5

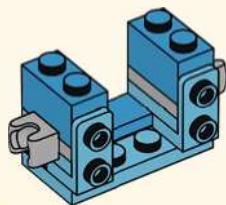

4x

6

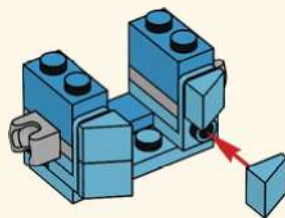

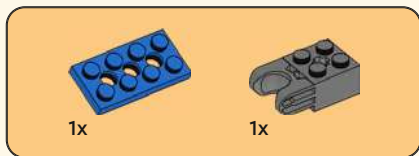

7

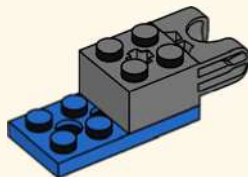

8

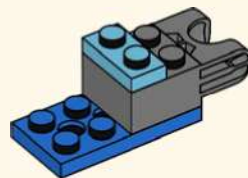

9

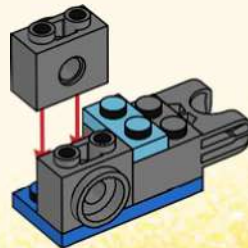



1x



1x

10

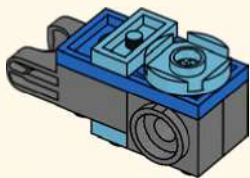

1x

11

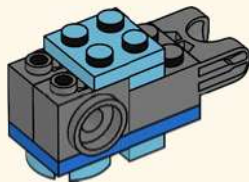



1x



1x

12

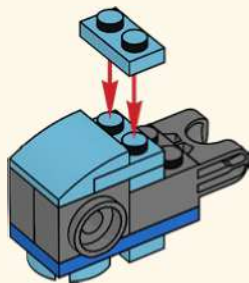

13

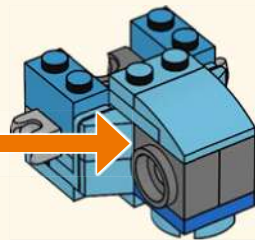



1x

14

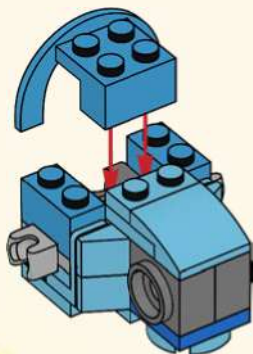

2x



1x

15

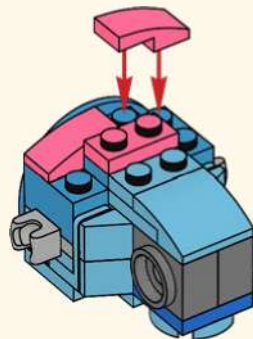



16

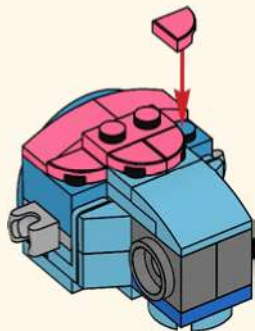

17

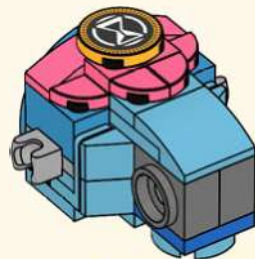



1x



1x

18

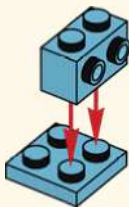

1x

19

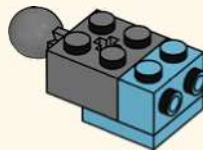



2x

20



2x

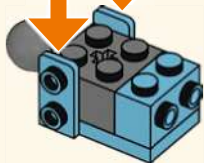

1x



2x

21

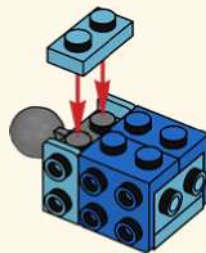



4x

22

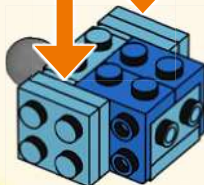
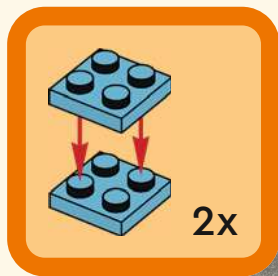

2x

23





1x



1x

24

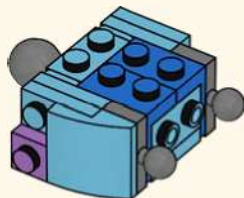

1x



1x

25

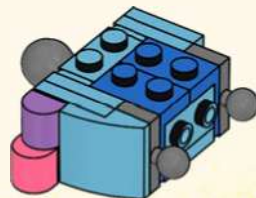



1x



1x

26

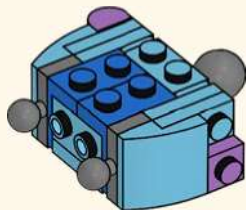

1x



1x

27





28

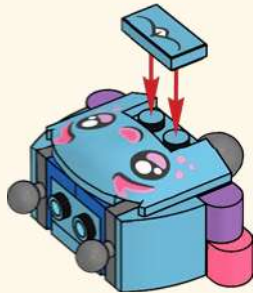

29

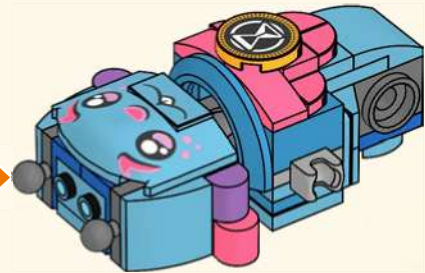

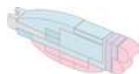

2x



1x



1x

30

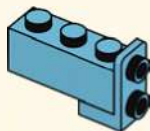

1x

31

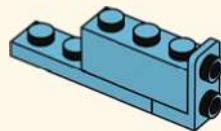



2x

32

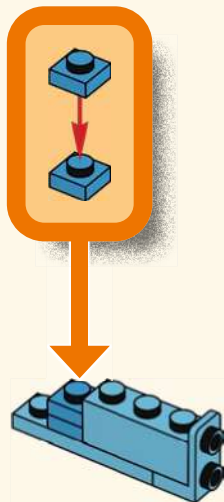

1x



1x

33

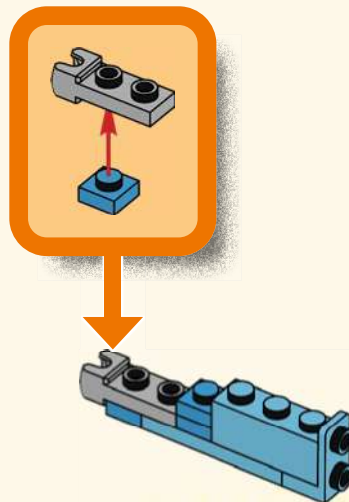

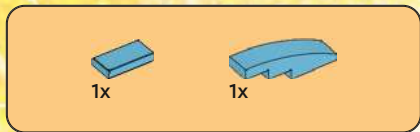

34

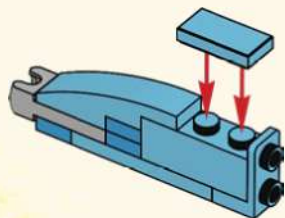

35

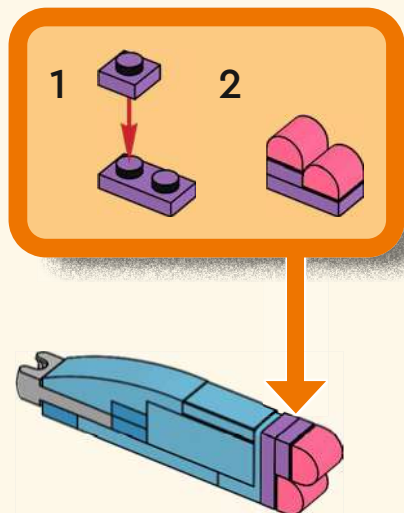



36

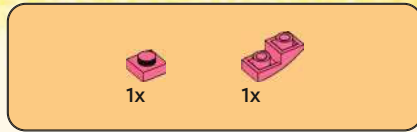
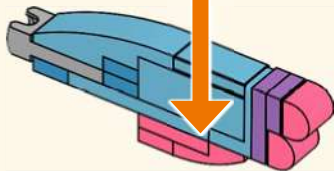
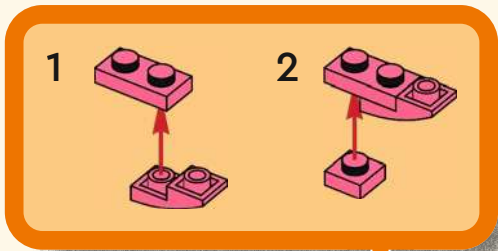

37

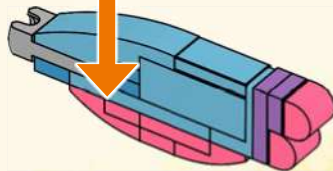
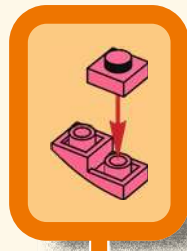

2x

38

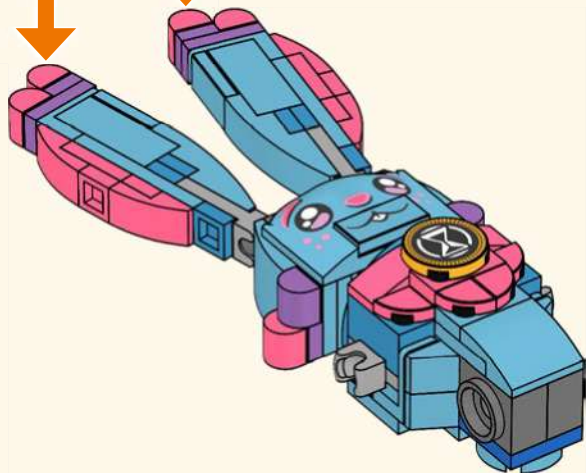





2x



1x



1x

39



1x

40

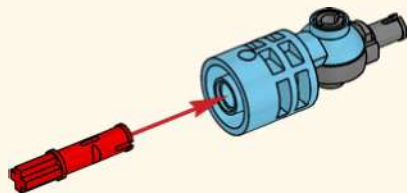



41

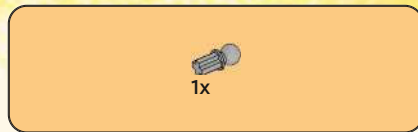

42

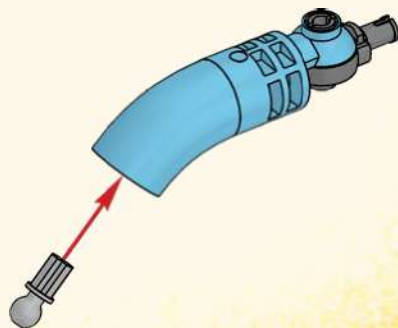

2x

43

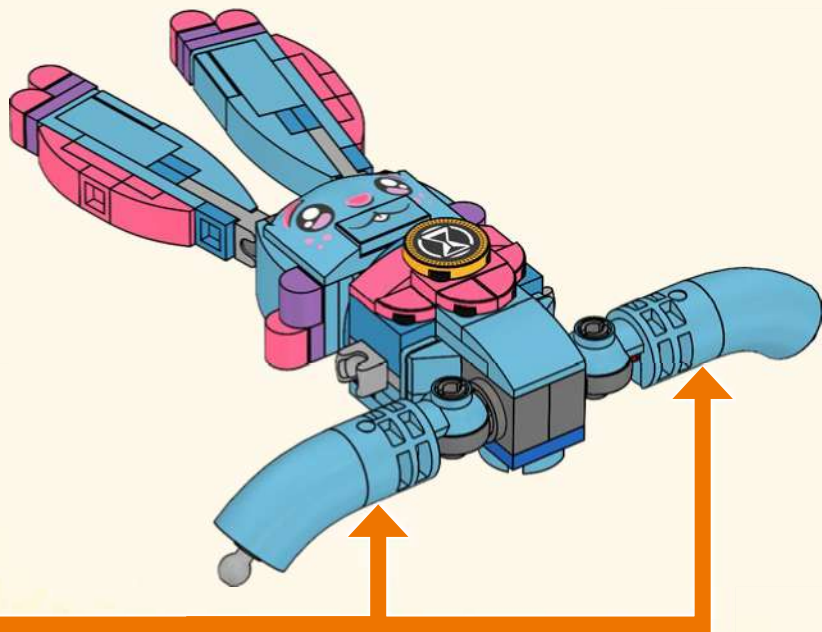

44

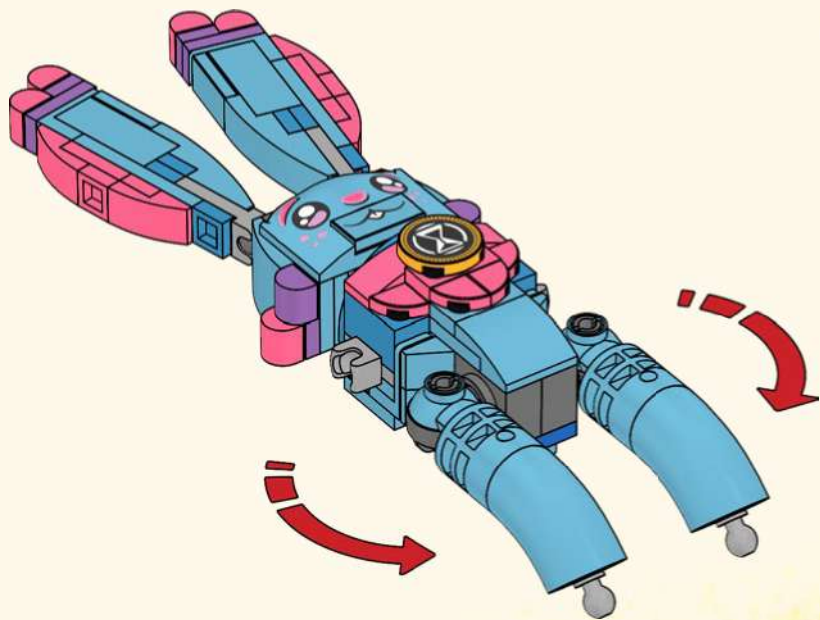



1x



1x

45

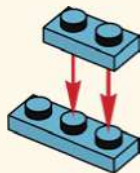

1x



1x

46

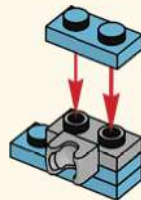



1x

47

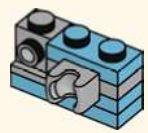

1x



1x



1x



1x

48

1

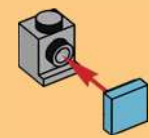

2

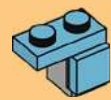

3

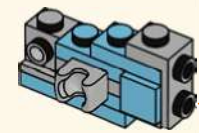



1x

49

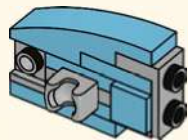

1x



1x



1x

50

1



2

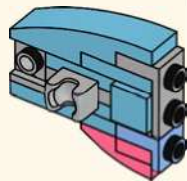



1x



1x

51

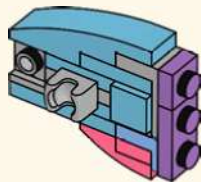

3x



1x

52

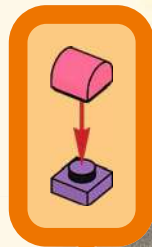
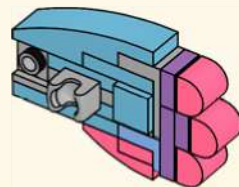



53

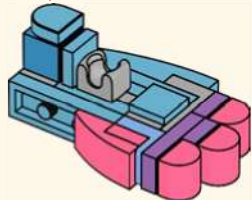
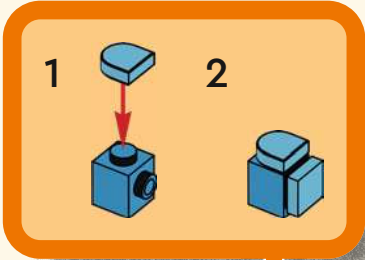

54

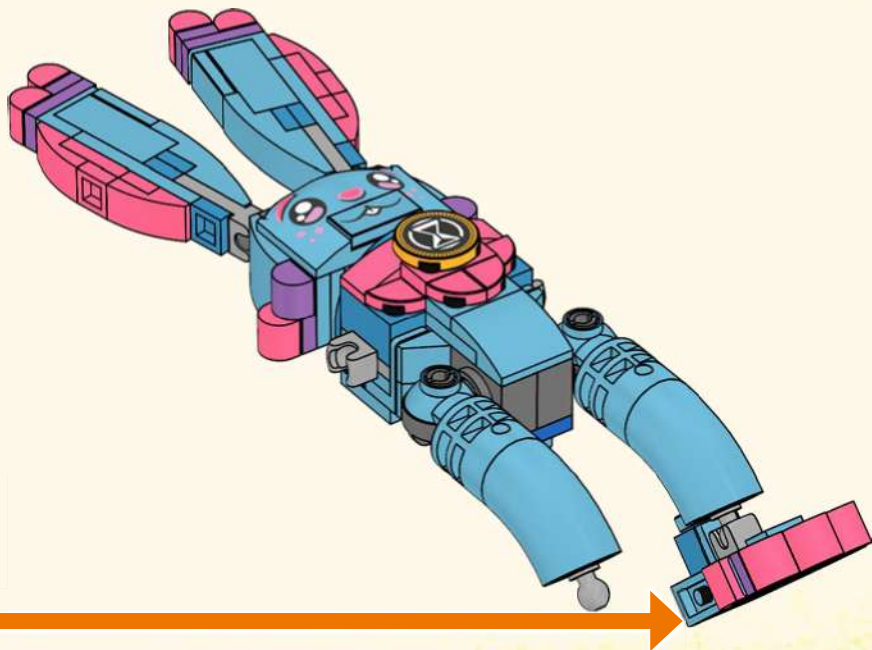

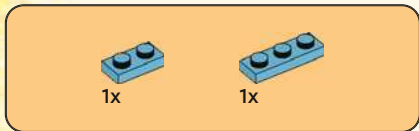

55

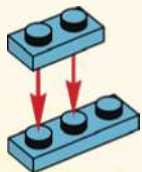

56

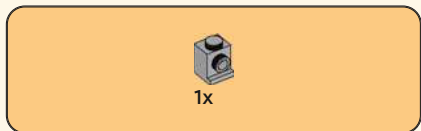
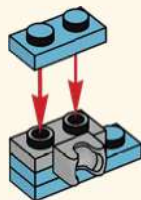

57

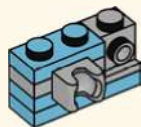

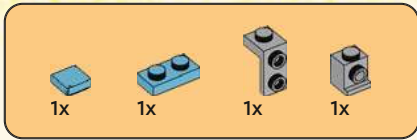

58

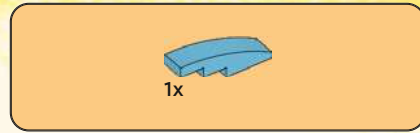
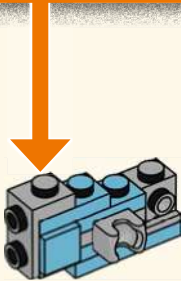
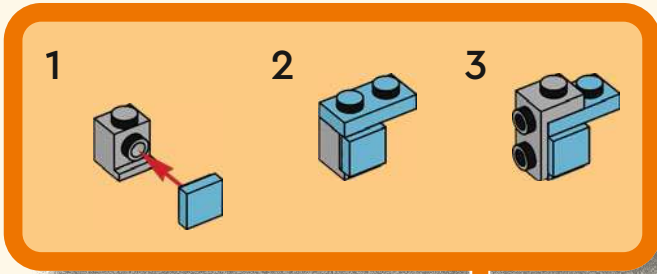

59

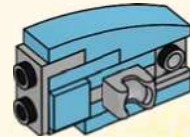



60

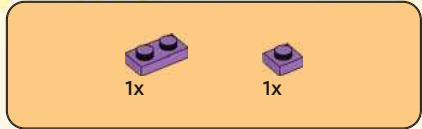
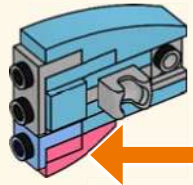
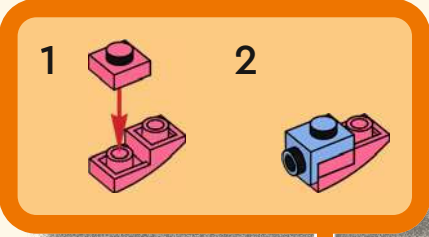

61

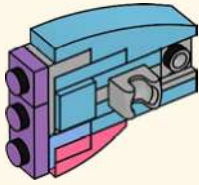



3x



1x

62

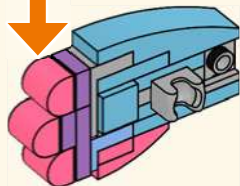

1x



1x



1x

63

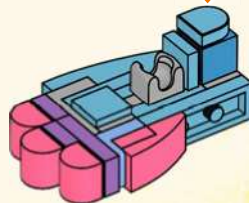
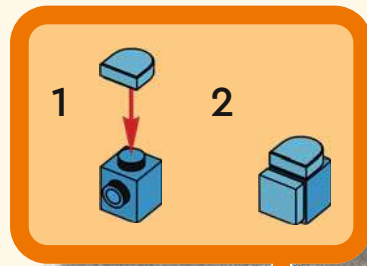

64

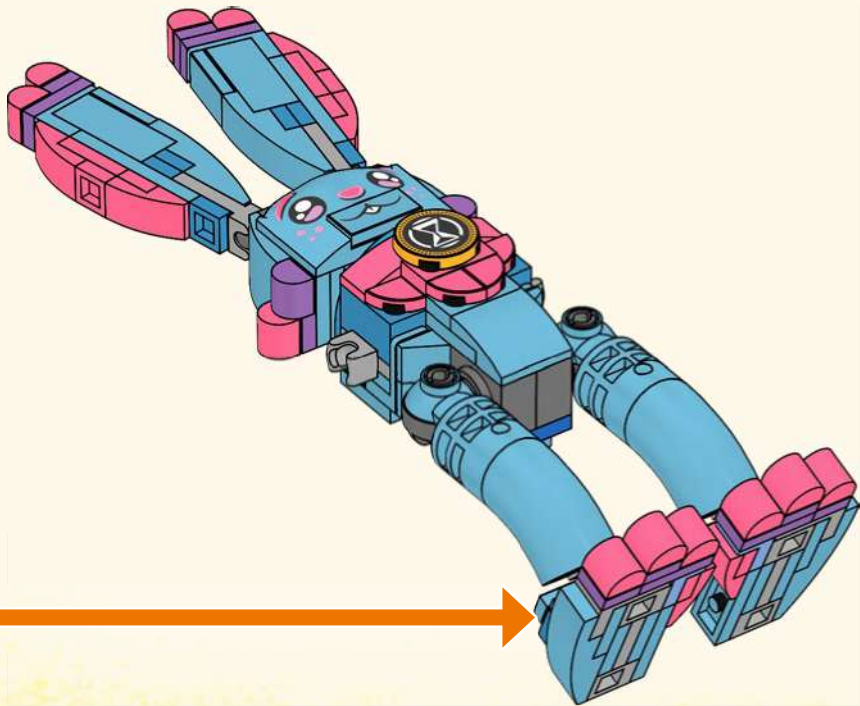



1x



1x

65



1x

66



1x

67





1x

68



3x

69

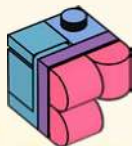

1x



1x

70

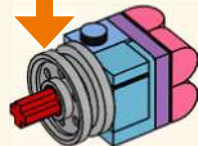
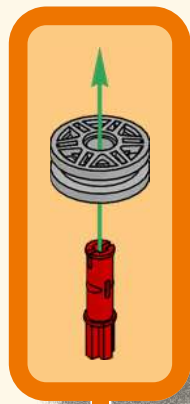

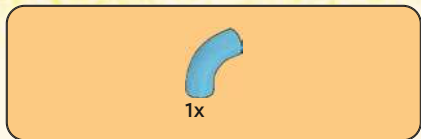

71

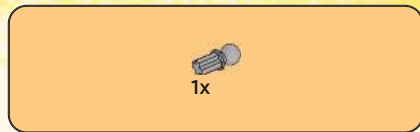
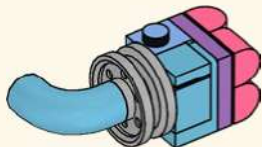

72

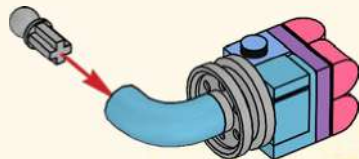

73

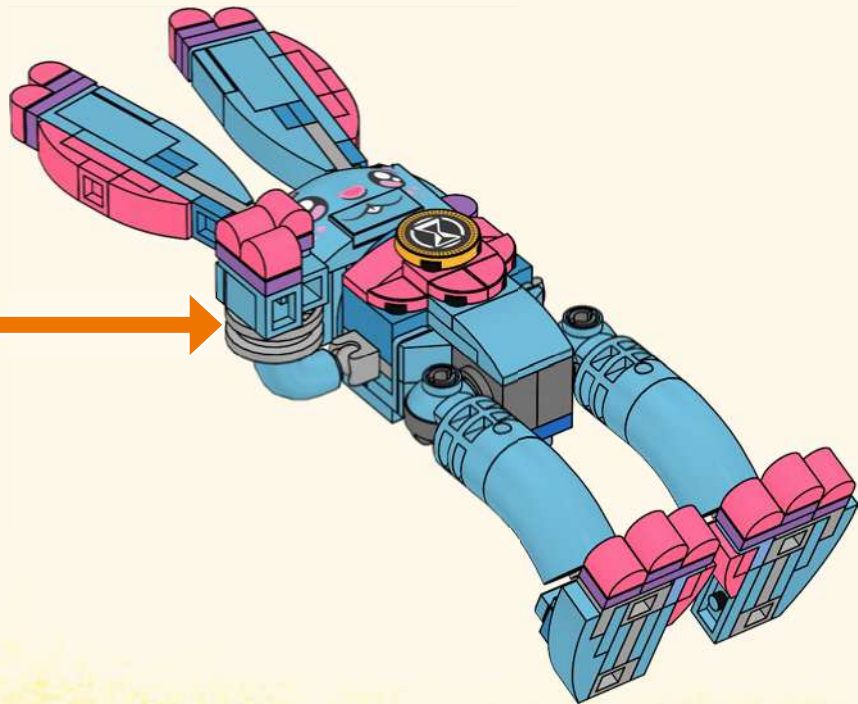



1x



1x

74



1x

75



1x

76





77



78

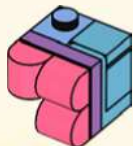

79

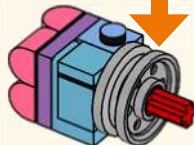
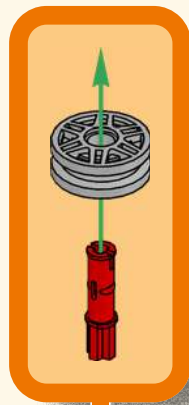

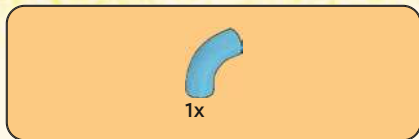

80

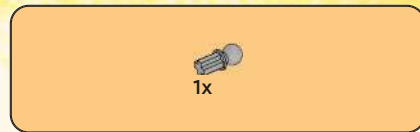
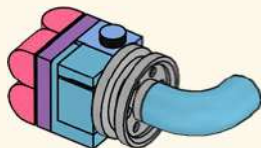

81

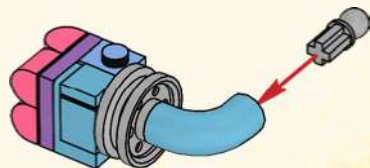

82

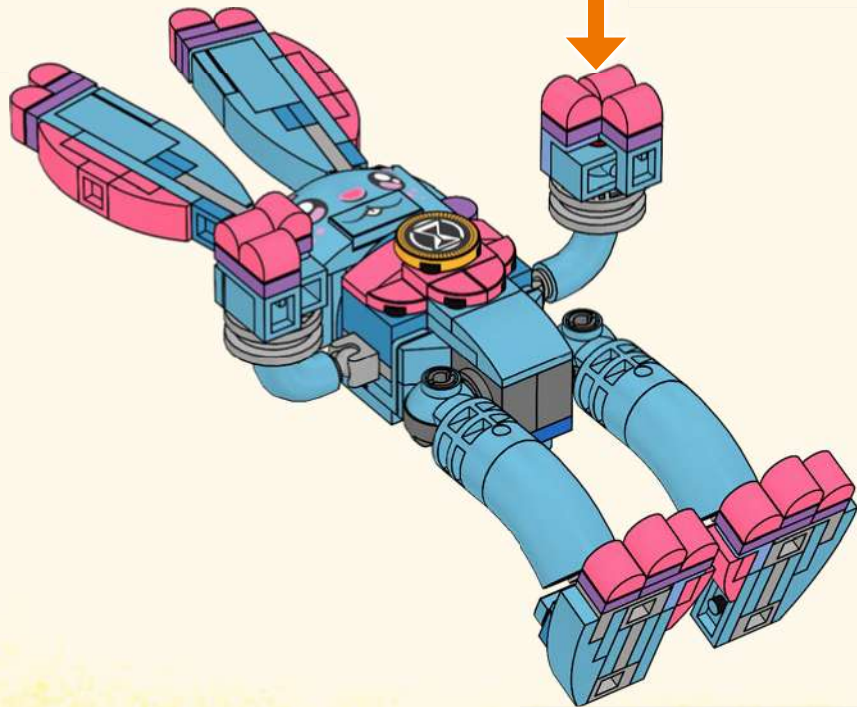



1x

83

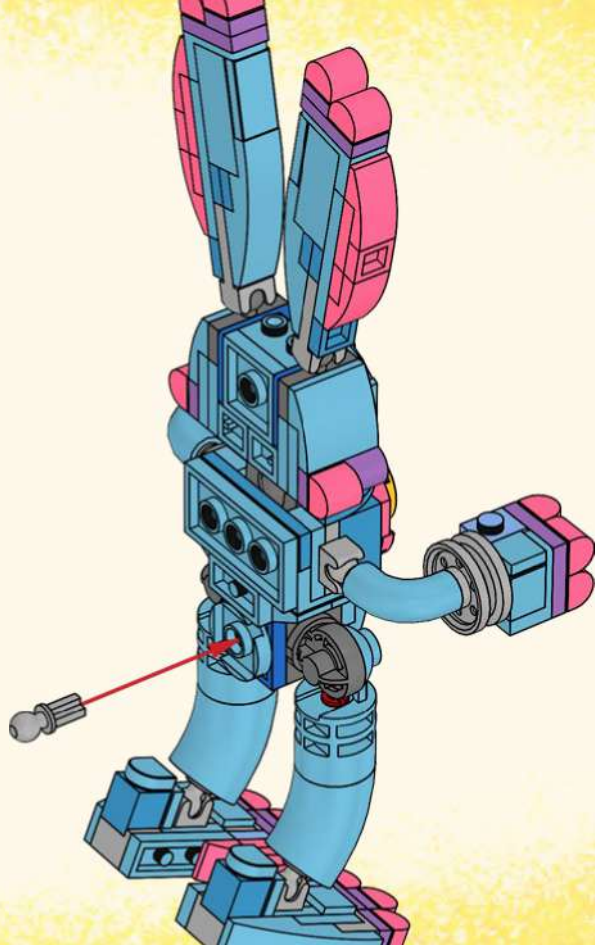

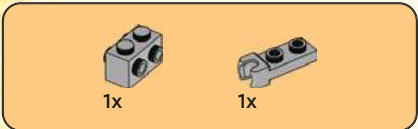

84

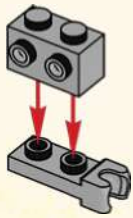

85

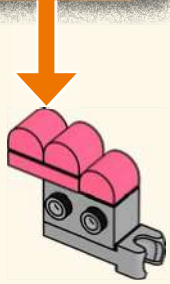
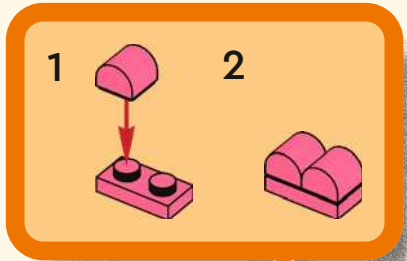



1x



1x

86

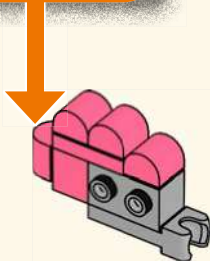
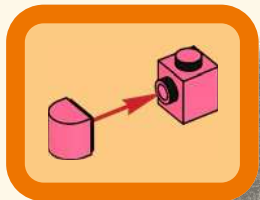

1x



1x

87

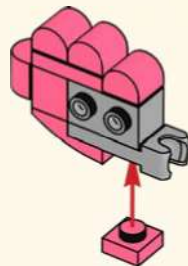

2x

88

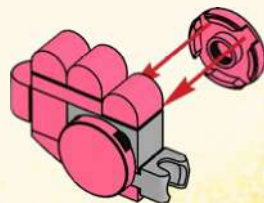

89

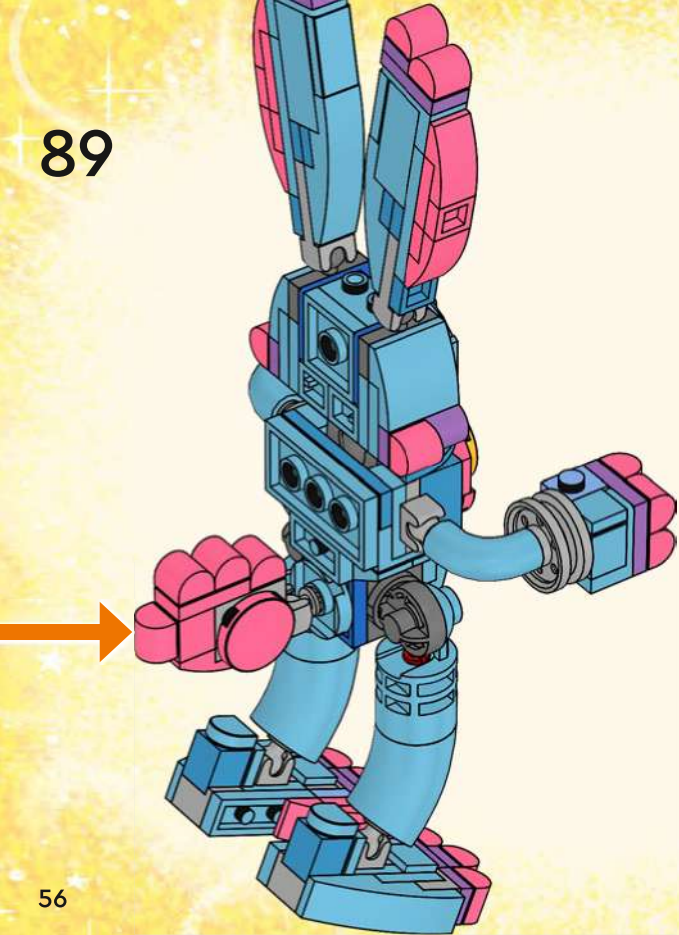



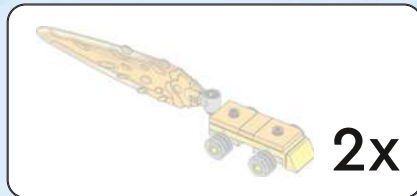

1

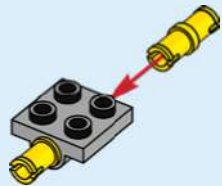



1x

2



1x

3

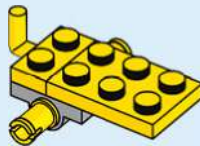



4

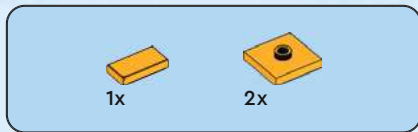
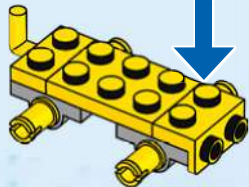
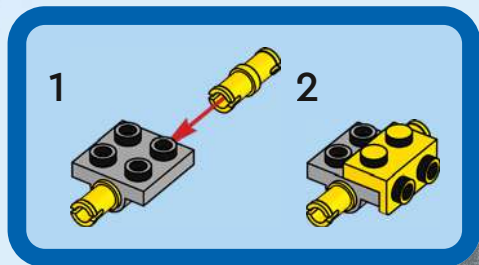

5

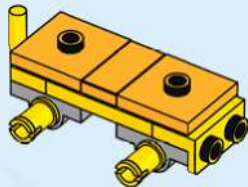



1x

6

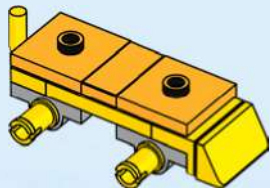

4x

7

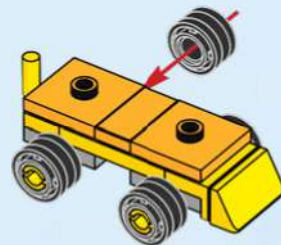

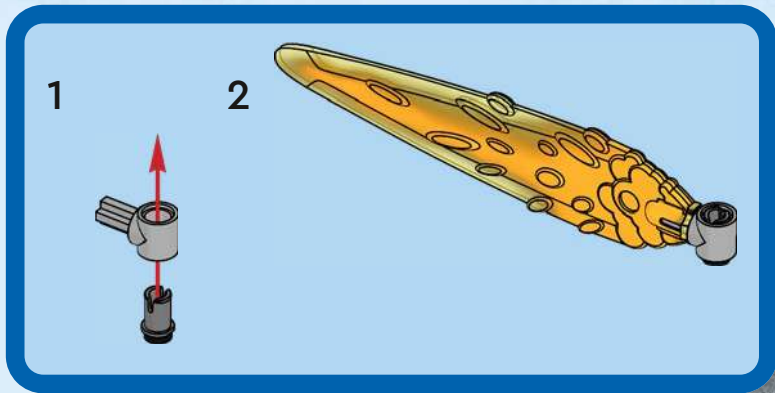
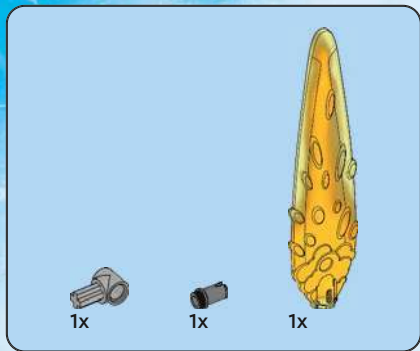

8

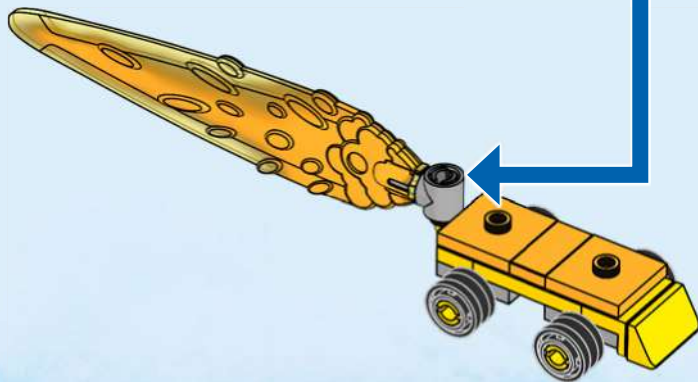

2x

9

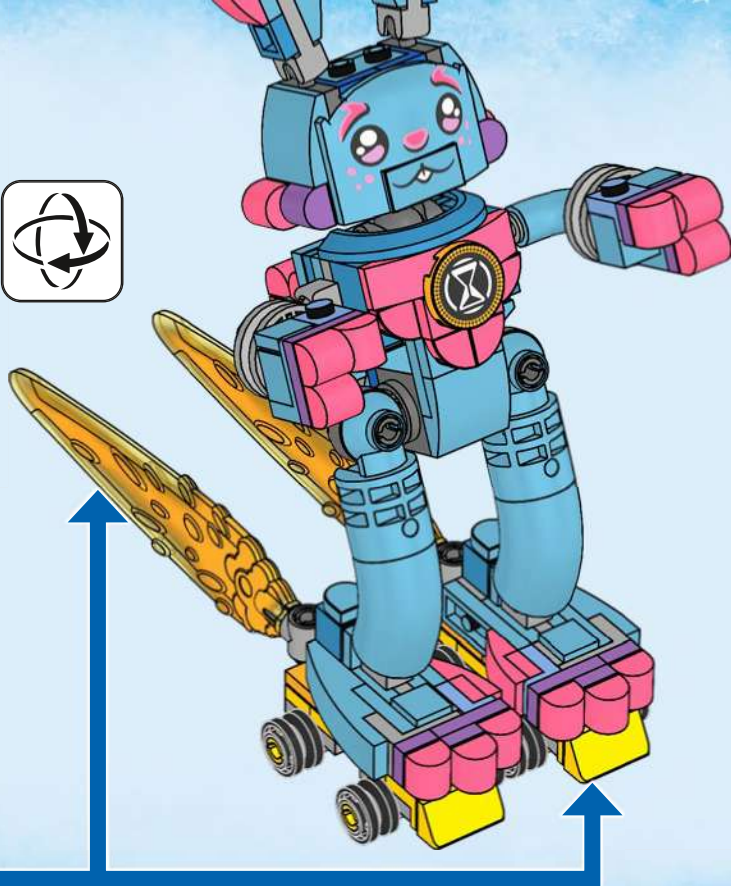



10

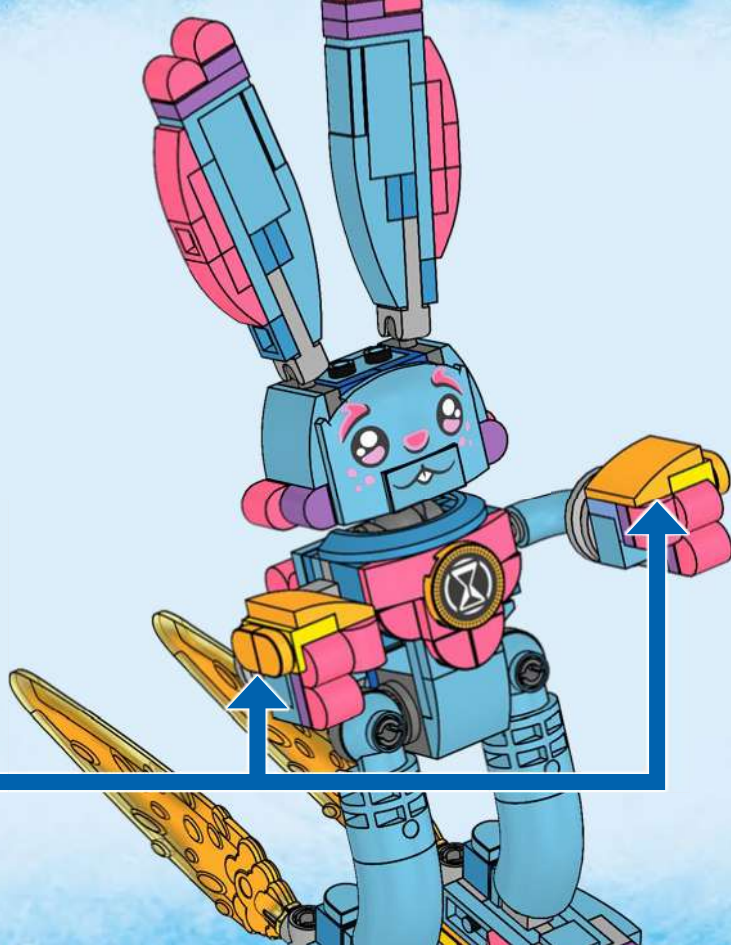
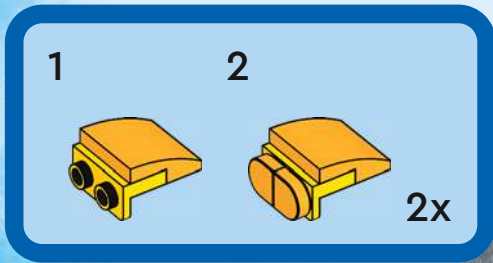



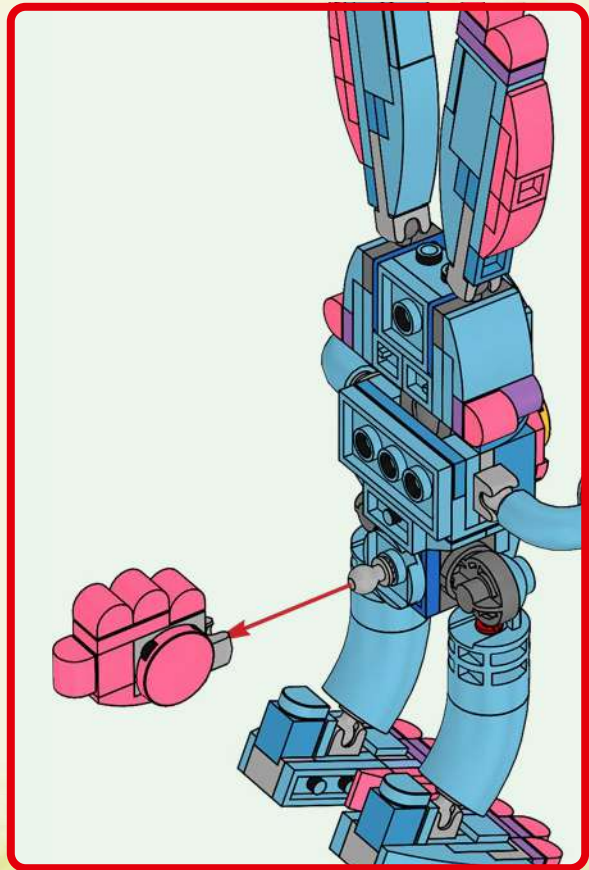



2x



2x

1

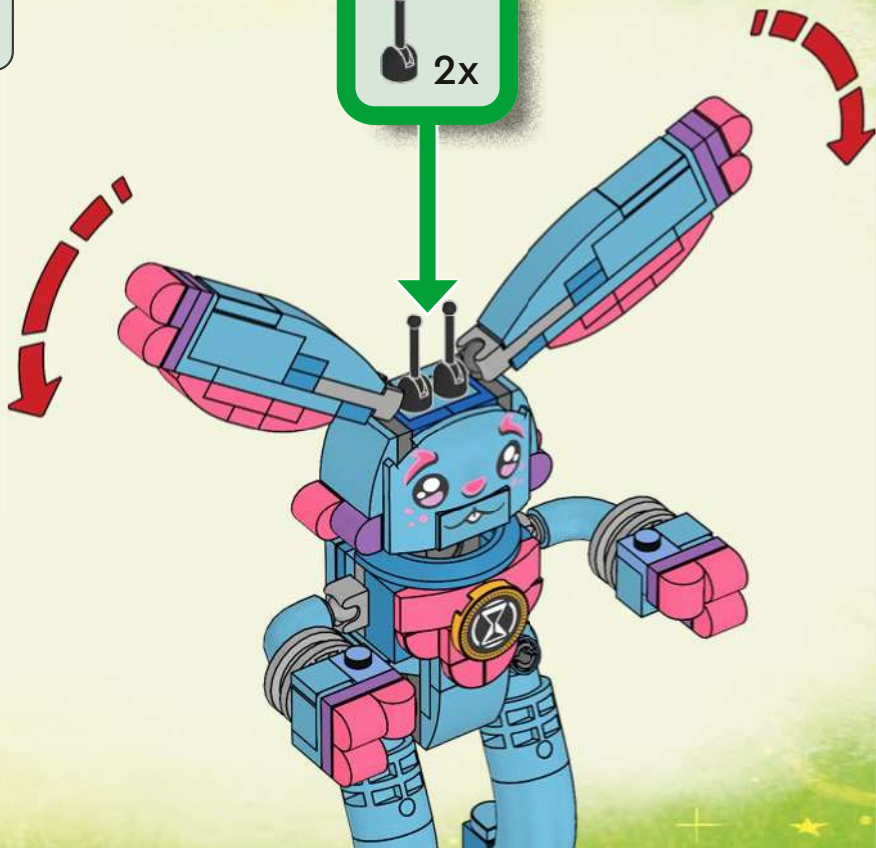



1x



1x

2



1x

3

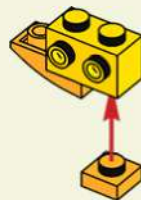

1x

4





1x

5



1x



1x

6

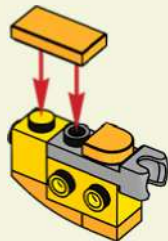

2x

7

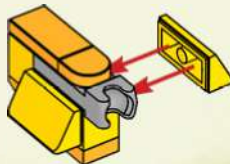



8

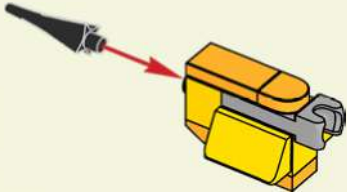

9

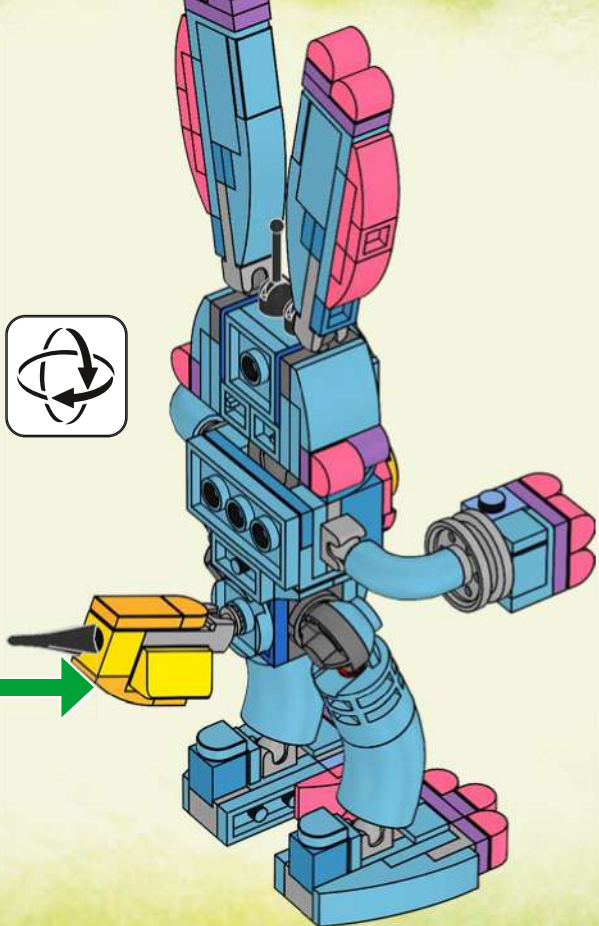
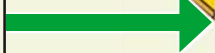

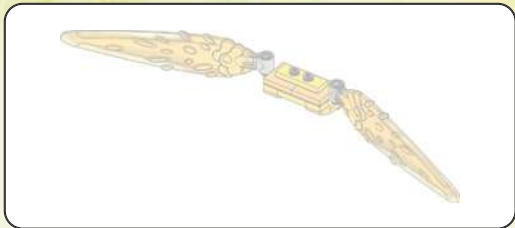

10



11



12

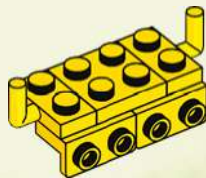



2x

13

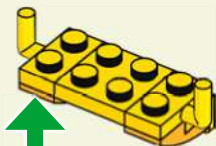

2x



2x

14



1x

15





2x



1x



1x



1x

16

1

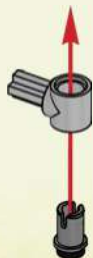

2

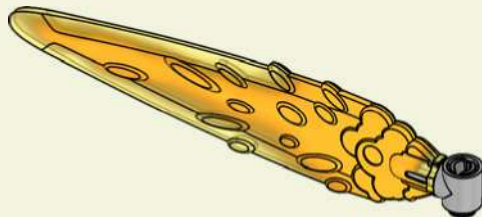

2x

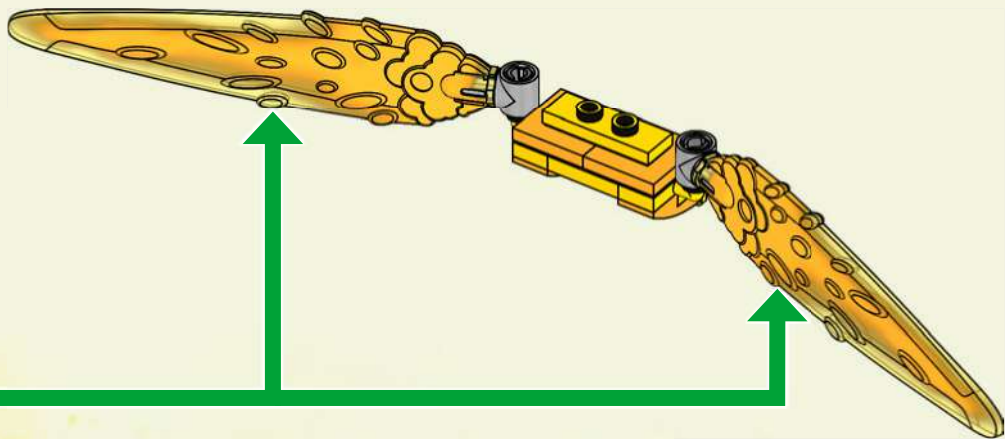

17

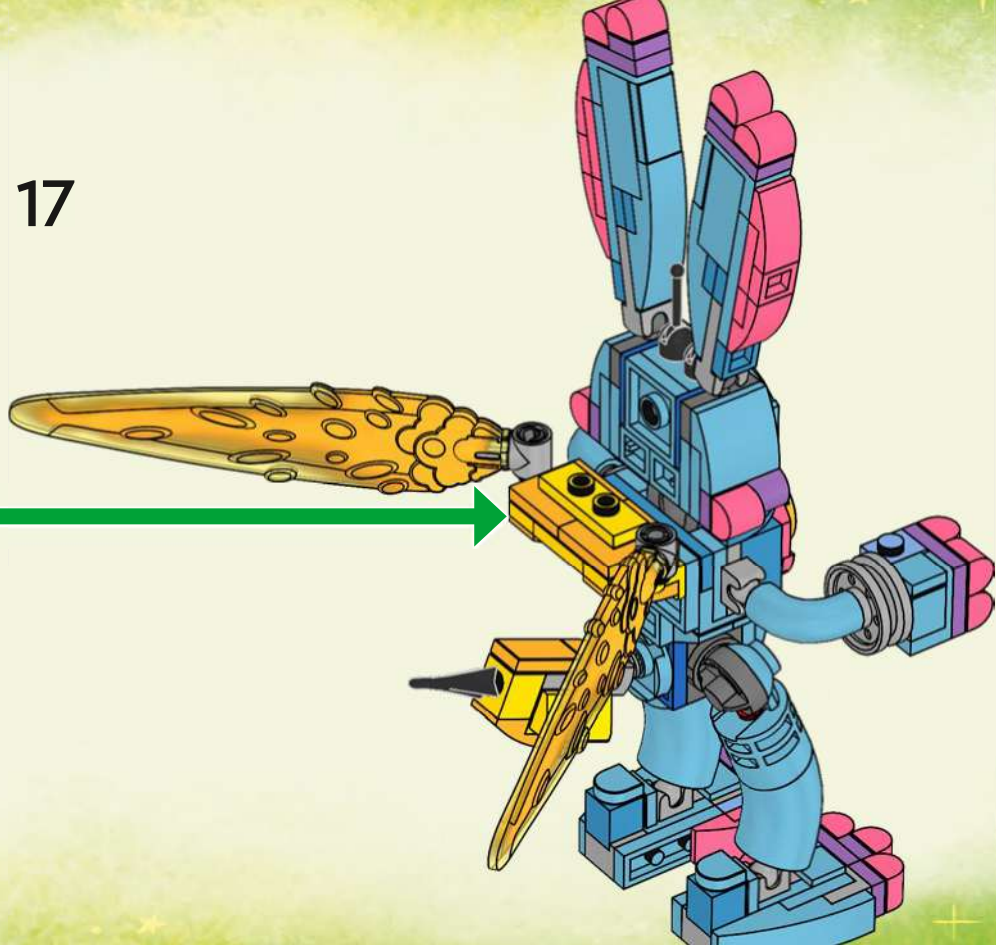

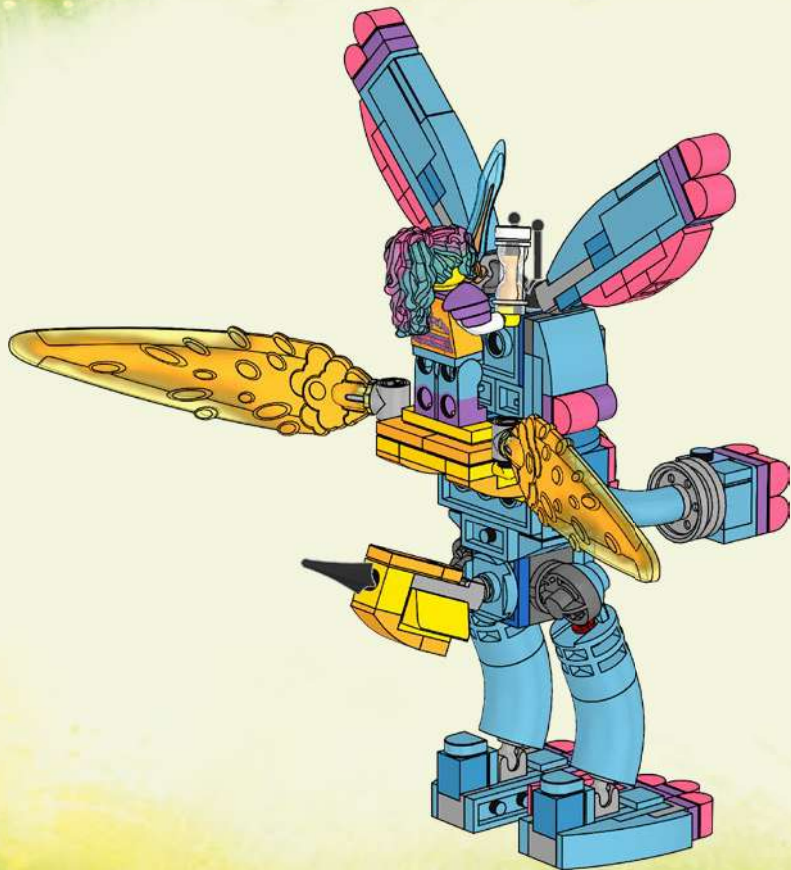



LEGO

DREAMZZZ



71453



71454



71455



71459



71460



71456



71457



71458



71461



71469

Watch series online
Schau dir die Serie online an
Regarde la série en ligne
Guarda la serie online
Mira la serie en Internet
Assistir à série online
在线观看
Oglądaj serial w internecie
Sleduj seriál online
Pozri si seriál online
Nézd a sorozatot online
Vizionează serialul online
Глядите сериала онлайн
Skaties seriālu tiešsaistē
Vaata sarja veebist
Žiūrėk serialą internetu



WATCH
SERIES
ONLINE



LEGO.com/DREAMZZZ



Rebuild
the
world™





1x
6434196



4x
6209519



2x
6117968



1x
370923



1x
6434190



1x
4624985



2x
4550348



8x
6331822



1x
6289719



2x
6261356



4x
6185994



1x
302224



1x
6228602



2x
302124



1x
6269965



2x
73587



1x
6434214



1x
6349966



8x
6291068



1x
6430884



1x
6440804



2x
6447085



4x
6248079



1x
6303223



4x
6313554



1x
6073040



1x
6434197



3x
6145215



3x
4622062



4x
6193972



2x
6099730



1x
6443633



4x
4211476



2x
6362975



5x
6443149



2x
6123815



1x
4657459



4x
6043656



2x
6044729



4x
6043639



4x
4211376



1x
6253187



2x
6395635



2x
6398662



2x
6039479



2x
4522784



1x
4497253



1x
6338291



1x
6430886



8x
4619521



2x
6261546



4x
4619512



2x
4619517



1x
6443457



2x
6004938



1x
6133729



1x
6254046



6x
6151664



2x
6004943



4x
6250022



22x
6422223



7x
6258091



1x
6261292



7x
6438408



2x
6258405



4x
6258094



2x
6258075



2x
6375606



1x
6430878



4x
4619520



6x
4655243



8x
6369798



1x
6109752



2x
6369800



1x
6434193



2x
6322828



1x
6434198



1x
6348142



2x
4649741



6x
4625032



3x
6119126



2x
6119107



2x
6223734



2x
6447228



4x
6347671



2x
6070757



1x
6434195



1x
4655256



1x
6434192



12x
6097419



2x
6322807



[LEGO.com/service](https://www.lego.com/service)

YOU COULD
WIN



Scan this QR code or go to
LEGO.COM/PRODUCTFEEDBACK and give
us your short feedback about this LEGO® set
for a chance to win a cool LEGO prize.

Terms and Conditions apply*

EN: YOU COULD WIN. Terms and Conditions apply* **DE: Du könntest GEWINNEN.** Es gelten die Teilnahmebedingungen* **FR: Tu pourrais GAGNER.** Des conditions s'appliquent* **IT: Potresti VINCERE tu.** Termini e condizioni sono applicabili* **ES: Puedes GANAR.** Aplican términos y condiciones* **PT: Poderá GANHAR.** Aplicam-se termos e condições* **ZH: 轻松获奖. 条款和条件适用*** **PL: Szansa na WYGRANĄ.** Obowiązują warunki korzystania* **CS: Máte šanci VYHRÁT.** Platí všeobecné smluvní podmínky* **SK: Máte šancu VYHRÁŤ.** Platia všeobecné zmluvné podmienky* **HU: TE IS NYERHETSZ.** Felhasználási feltételek érvényesek* **RO: Ai putea CÂȘTIGA.** Se aplică termenii și condiții* **BG: Можете да СПЕЧЕЛИТЕ.** Има определени правила и условия* **LV: Tu vari LAIMĒT.** Ir spēkā noteikumi un nosacījumi.* **ET: Sul on võimalus VÕITA.** Kehtivad tingimused* **LT: Jūs galite LAIMĖTI.** Taikomos sąlygos*

*[LEGO.com/productfeedback-terms](https://www.lego.com/productfeedback-terms)